

SBE 16plus V2 SeaCAT

*Conductivity and Temperature Recorder (pressure optional)
with **RS-232** Interface*



User's Manual

Sea-Bird Electronics, Inc.
13431 NE 20th Street
Bellevue, Washington 98005 USA
Telephone: +` 425-643-9866
Fax: +1 425-643-9954
seabird@seabird.com
www.seabird.com

Manual Version #009, 09/24/12
Firmware Version 2.5 and later
SeatermV2 Version 2.2.2 and later
Seasave V7 Version 7.2.2 and later
SBE Data Processing Version 7.2.2 and later



Limited Liability Statement

Extreme care should be exercised when using or servicing this equipment. It should be used or serviced only by personnel with knowledge of and training in the use and maintenance of oceanographic electronic equipment.

SEA-BIRD ELECTRONICS, INC. disclaims all product liability risks arising from the use or servicing of this system. SEA-BIRD ELECTRONICS, INC. has no way of controlling the use of this equipment or of choosing the personnel to operate it, and therefore cannot take steps to comply with laws pertaining to product liability, including laws which impose a duty to warn the user of any dangers involved in operating this equipment. Therefore, acceptance of this system by the customer shall be conclusively deemed to include a covenant by the customer to defend, indemnify, and hold SEA-BIRD ELECTRONICS, INC. harmless from all product liability claims arising from the use or servicing of this system.

Declaration of Conformity

Sea-Bird Electronics, Inc.
13431 NE 20th Street, Bellevue, WA 98005 USA

DECLARATION OF CONFORMITY

Manufacturer's Name: Sea-Bird Electronics
Manufacturer's Address: 13431 NE 20th Street
Bellevue, WA 98005, USA

The Authorized Representative located within the Community is:
OTT MESSTECHNIK GmbH & Co.KG
P.O.Box: 2140 / 87411 Kempten / Germany
Ludwigstrasse 16 / 87437 Kempten
Internet: <http://www.ott.com>
Phone: +49 831 5617 – 100
Fax: +49 831 5617 - 209

Device Description: Various Data Acquisition Devices and Sensors

Model Numbers:

3S	3F	3plus	4C	4M	5T	5P	5M	7
8	9plus	11plus	14	16plus V2	16plus-IM V2		17plus V2	18
19plus V2	21	25plus	26plus	27	29	32	32C	32SC
33	35	35RT	36	37-IMP	37-IM	37-SMP	37-SM	37-SIP
37-SI	38	39	39-IM	41	41CP	43	43F	44
45	49	50	52-MP	53BPR	54	55	56	63
SIM	ICC	IMM	PDIM	AFM	90488	90204	90402	90504
Glider Payload CTD		NiMH Battery Charger and Battery Pack						

Applicable EU Directives: Machinery Directive 98 / 37 /EC
EMC Directive 2004 / 108 /EC
Low Voltage Directive (73 / 23 /EEC) as amended by (93 / 68 /EEC)

Applicable Harmonized Standards:
EN 61326-1:2006 Class A Electrical Equipment for Measurement, Control, and Laboratory Use, EMC Requirement – Part 1: General Requirements
(EN 55011:2007 Group 1, Class A)

EN 61010-1:2001, Safety Requirements for Electrical Equipments for Measurement, Control, and Laboratory Use – Part 1: General Requirements

Declaration based upon compliance to the Essential Requirements and Letter of Opinion from CKC Certification Services, LLC., Notified Body 0976

I, the undersigned, hereby declare that the equipment specified above conforms to the above European Union Directives and Standards.

Authorized Signature: 
Name: Nordeen Larson
Title of Signatory: President
Date: 27 June 2012
Place: Bellevue, WA

Table of Contents

Limited Liability Statement	2
Declaration of Conformity	3
Table of Contents	4
Section 1: Introduction	6
About this Manual	6
Quick Start	6
Unpacking SBE 16 <i>plus</i> V2	7
Section 2: Description of SBE 16<i>plus</i> V2	8
System Description	8
Specifications.....	10
Dimensions and End Cap Connectors.....	12
Cables	13
Data I/O	14
Data Storage.....	14
Sample Timing.....	15
Batteries	15
Battery Endurance.....	16
External Power.....	17
Cable Length and External Power	17
Configuration Options and Plumbing	19
Section 3: Power and Communications Test	21
Software Installation	21
Test Setup	22
Test	23
Section 4: Deploying and Operating SBE 16<i>plus</i> V2	28
Sampling Modes	28
Polled Sampling.....	28
Autonomous Sampling (logging).....	29
Serial Line Synchronization (Serial Line Sync)	30
Pump Operation	32
Pump Setting Recommendations	33
Real-Time Setup	34
Baud Rate and Cable Length	34
Real-Time Data Acquisition	35
Timeout Description	35
Command Descriptions.....	36
Data Output Formats.....	63
Setup for Deployment.....	70
Deployment.....	71
Acquiring Real-Time Data with Seasave.....	72
Verifying Contents of Configuration (.xmlcon or .con) File	72
Acquiring Real-Time Data.....	74
Recovery	75
Physical Handling.....	75
Uploading Data.....	76
Processing Data Using SBE Data Processing	80
Verifying Contents of Configuration (.xmlcon or .con) File	80
Editing Raw Data File.....	81

Section 5: Routine Maintenance and Calibration	82
Corrosion Precautions.....	82
Connector Mating and Maintenance	82
Replacing Alkaline Batteries	83
Conductivity Cell Maintenance	84
Internally Mounted Pressure Sensor (optional) Maintenance	85
Pump (optional) Maintenance.....	85
Replacing Anti-Foulant Devices (SBE 16 <i>plus</i> , SBE 19 <i>plus</i>).....	86
Sensor Calibration.....	87
Section 6: Troubleshooting	89
Problem 1: Unable to Communicate with SBE 16 <i>plus</i> V2	89
Problem 2: No Data Recorded	89
Problem 3: Unable to View Data in Seasave (Real-Time Data Acquisition program)	89
Problem 4: Scan Length Error in SBE Data Processing or Seasave	90
Problem 5: Nonsense or Unreasonable Data.....	90
Problem 6: Less Data than Expected	91
Problem 7: Program Corrupted	91
Glossary	92
Appendix I: Functional Description and Circuitry	94
Sensors.....	94
Sensor Interface	94
Real-Time Clock.....	94
Battery Wiring	95
Appendix II: Electronics Disassembly/Reassembly	96
Appendix III: Command Summary	97
Appendix IV: AF24173 Anti-Foulant Device	101
Appendix V: Replacement Parts	105
Appendix VI: Manual Revision History	108
Index	110

Section 1: Introduction

This section includes a Quick Start procedure, and photos of a standard SBE 16plus V2 shipment.

About this Manual

This manual is to be used with the SBE 16plus V2 SeaCAT Conductivity and Temperature (pressure optional) Recorder. It is organized to guide the user from installation through operation and data collection. We have included detailed specifications, command descriptions, maintenance and calibration information, and helpful notes throughout the manual.

Sea-Bird welcomes suggestions for new features and enhancements of our products and/or documentation. Please contact us with any comments or suggestions (seabird@seabird.com or 425-643-9866). Our business hours are Monday through Friday, 0800 to 1700 Pacific Standard Time (1600 to 0100 Universal Time) in winter and 0800 to 1700 Pacific Daylight Time (1500 to 0000 Universal Time) the rest of the year.

Quick Start

Follow these steps to get a Quick Start using the SBE 16plus V2. The manual provides step-by-step details for performing each task:

1. Test power and communications (*Section 3: Power and Communications Test*).
2. Deploy the 16plus V2 (*Section 4: Deploying and Operating SBE 16plus V2*):
 - A. Install new batteries if necessary.
 - B. Ensure all data has been uploaded, and then send **InitLogging** to make entire memory available for recording if desired.
 - C. Set date and time (**DateTime=**) and establish setup and logging parameters.
 - D. Check status (**DS**) and calibration coefficients (**DCal**) to verify setup.
 - E. Set 16plus V2 to start logging now (**StartNow**) or in the future (**StartDateTime=** and **StartLater**).
 - F. Install dummy plugs and/or cable connectors, and locking sleeves.
 - G. Remove protective plugs from anti-foulant device cups, and verify AF24173 Anti-Foulant Devices are installed. Leave protective plugs off for deployment.
 - H. Deploy 16plus V2, using customer-supplied hardware.

Unpacking SBE 16plus V2

Shown below is a typical SBE 16plus V2 shipment.

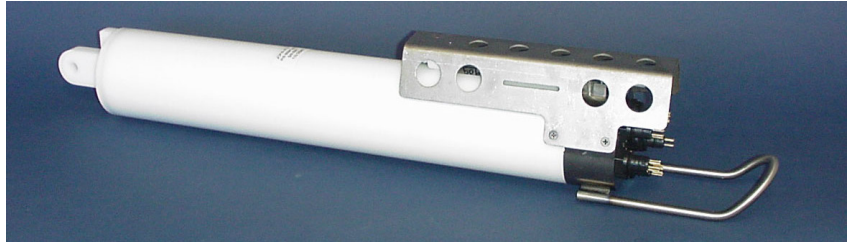

SBE 16plus V2 SeaCAT
(shown in plastic housing)



I/O extension cable
(6-pin to 4-pin; for use when
configured without pump)



I/O Cable
(4-pin to DB-9S)



Spare o-ring and
hardware kit



Conductivity cell filling
and storage kit



Conductivity cell cleaning
solution (Triton-X)



Software, and Electronic Copies of
Software Manuals and User Manual

Section 2: Description of SBE 16plus V2

This section describes the functions and features of the SBE 16plus V2 SeaCAT, including:

- system description
- specifications
- dimensions and end cap connectors
- communication settings
- data storage
- batteries and battery endurance
- external power and cable length limitations
- configuration options and plumbing

System Description

The SBE 16plus V2 SeaCAT is designed to measure conductivity, temperature, and (optional) pressure in marine or fresh-water environments in moored applications at depths up to 10,500 meters (34,400 feet).

The 16plus V2 operates as follows:

- **Autonomous sampling** - The 16plus V2 can acquire and record in memory time series measurements at sample rates of once every 10 sec to once every 4 hours, adjustable in one-sec increments. Between samples, the 16plus V2 powers down, drawing only 20 microamps. Simultaneous, real-time data transmission is possible using the 16plus V2 three-wire RS-232C interface.
- **Polled sampling** – A surface controller can request the last sample that was taken or ask the 16plus V2 to take a new sample. Data is transmitted over the RS-232 interface.
- **Serial line sync** – The 16plus V2 wakes up, samples, stores data in memory, transmits real-time data (if enabled), and powers off in response to a pulse on the serial line. This provides an easy method for synchronizing 16plus V2 sampling with other instruments such as Acoustic Doppler Current Profilers (ADCPs) or current meters, without drawing on their battery or memory resources.

Self-powered and self-contained, the SBE 16plus V2 features the proven Sea-Bird conductivity and temperature sensors. Nine D-size alkaline batteries provide power for approximately 355,000 samples (with no internally mounted pressure sensor, pump, or auxiliary sensors). The 64 Mbyte FLASH RAM memory records 2 years of conductivity, temperature, and date/time data while sampling every 10 sec (other configurations/setup vary). User-selectable output format is raw data or engineering units, in hexadecimal or decimal form; XML output is also available. Setup, diagnostics, and data extraction are performed without opening the housing. The 16plus V2 can power external sensors and acquire their outputs.

A standard SBE 16*plus* V2 is supplied with:

- Plastic housing for depths to 600 meters (1950 feet)
- Bulkhead connectors (Impulse glass-reinforced epoxy):
 - one 6-pin connector for data I/O, external power, and pump power;
 - three 6-pin connectors, for two differential auxiliary A/D inputs each;
 - one 4-pin connector, for RS-232 auxiliary sensor (SBE 63 optical dissolved oxygen sensor, SBE 38 secondary temperature sensor, SBE 50 pressure sensor, WET Labs sensor [single, dual, or triple channel ECO sensor; WETStar; or C-Star], up to two Pro-Oceanus Gas Tension Devices, or Aanderaa Oxygen Optode 4330 or 4835)
- 64 Mbyte FLASH RAM memory
- 9 D-size alkaline batteries (Duracell MN1300, LR20)
- Anti-foulant device attachments and expendable AF24173 Anti-Foulant Devices. These are attached to each end of the conductivity cell, so that any water that enters the cell is treated.

SBE 16*plus* V2 options include:

- Titanium housing for use to 7000 or 10500 meters (22,900 or 34,440 feet)
- Internally mounted pressure sensor -
 - Strain gauge pressure sensor, or
 - Quartz pressure sensor
- Pump -
 - SBE 5M (plastic or titanium housing) for pumped conductivity, or
 - SBE 5P (plastic housing) or 5T (titanium housing) for pumped conductivity **and** pumped auxiliary sensors
- Sensors for dissolved oxygen, fluorescence, light (PAR), light transmission, turbidity, and gas tension
- Wet-pluggable (MCBH) connectors in place of standard connectors
- **Inductive Modem (IM)** interface in place of RS-232 - The IM uses a mooring cable as the communication link, permitting the 16*plus*-IM V2 to be easily positioned at any depth without the use of cable connectors. Each inductive modem instrument has a programmable address, allowing up to 100 IM instruments to be attached to a single mooring cable. See the *SBE 16plus-IM V2 SeaCAT Manual*.
- Battery pack kit for lithium batteries for longer deployments (lithium batteries **not** supplied by Sea-Bird).

Note:

The lithium battery pack cannot be used with a 16*plus* V2 that is integrated with an SBE 5T or 5P pump.

Future upgrades and enhancements to the SBE 16*plus* V2 firmware can be easily installed in the field through a computer serial port and the *Data I/O, Pump, and External Power* bulkhead connector on the 16*plus* V2, without the need to return the 16*plus* V2 to Sea-Bird.

Notes:

- Help files provide detailed information on the software.
- Separate software manuals also provide information on Seasave V7 and SBE Data Processing.
- Sea-Bird also supplies an older version of Seasave, Seasave-Win32. However, Seasave-Win32 is not compatible with the 16*plus* V2.
- Sea-Bird supplies the current version of our software when you purchase an instrument. As software revisions occur, we post the revised software on our FTP site. See our website (www.seabird.com) for the latest software version number, a description of the software changes, and instructions for downloading the software from the FTP site.

The SBE 16*plus* V2 is supplied with a powerful Win 2000/XP software package, Seasoft V2, which includes:

- **Deployment Endurance Calculator** – program for determining deployment length based on user-input deployment scheme, instrument power requirements, and battery capacity.
- **SeatermV2** – terminal program for easy communication and data retrieval. SeatermV2 is a *launcher*. Depending on the instrument selected it launches **Seaterm232** (RS-232 instruments, such as this 16*plus* V2), **Seaterm485** (RS-485 instruments), or **SeatermIM** (inductive modem instruments).
- **Seasave V7** – program for acquiring, converting, and displaying real-time or archived raw data.
- **SBE Data Processing** – program for calculation and plotting of conductivity, temperature, pressure, auxiliary sensor data, and derived variables such as salinity and sound velocity.

Specifications

	Temperature (°C)	Conductivity (S/m)	Internally Mounted Pressure (optional)
Measurement Range	-5 to +35	0 to 9	0 to full scale range: • <i>Strain gauge sensor</i> : 20 / 100 / 350 / 600 / 1000 / 2000 / 3500 / 7000 meters • <i>Quartz sensor</i> : 20 / 60 / 130 / 200 / 270 / 680 / 1400 / 2000 / 4200 / 7000 / 10500 meters
Initial Accuracy	0.005	0.0005	• <i>Strain gauge sensor</i> : 0.1% of full scale range • <i>Quartz sensor</i> : 0.02% of full scale range
Typical Stability	0.0002/month	0.0003/month	• <i>Strain gauge sensor</i> : 0.1% of full scale range/year • <i>Quartz sensor</i> : 0.02% of full scale range/year
Resolution	0.0001	• 0.00005 (most oceanic water; resolves 0.4 ppm in salinity). • 0.00007 (high salinity water; resolves 0.4 ppm in salinity). • 0.00001 (fresh water; resolves 0.1 ppm in salinity).	• <i>Strain gauge sensor</i> : 0.002% of full scale range • <i>Quartz sensor</i> : 0.0006% of full scale range for 1-sec integration; depends on sample integration time (see notes below)
Sensor Calibration (measurement outside these ranges may be at slightly reduced accuracy due to extrapolation errors)	+1 to +32	0 to 9; physical calibration over range 2.6 to 6 S/m, plus zero conductivity (air)	Ambient pressure to full scale range in 5 steps

***Notes on Internally Mounted Quartz Pressure Sensor Resolution:**

Pressure Sensor Resolution = Sensitivity * Counter Resolution

- Sensitivity = Δ pressure / Δ frequency
 where Δ pressure is change in pressure in desired units (psia, db, meters, etc.) = pressure sensor full scale range
 Δ frequency is change in frequency in Hz \approx 3000 Hz over sensor's full scale range
- Counter Resolution = pressure sensor output frequency / (**ParosIntegration** * 1,843,200)
 where pressure sensor output frequency \approx 35,000 Hz
ParosIntegration = user-input integration time (sec)
- To convert pressure units: db = psia / 1.45

Example:

What resolution can be obtained for a 7000 meter (10,000 psia) Quartz pressure sensor?

Sensitivity = Δ pressure / Δ frequency = 7000 m / 3000 Hz = 2.333 m / Hz

Counter Resolution = pressure sensor output frequency / (**ParosIntegration** * 1,843,200)
 = 35,000 Hz / (**ParosIntegration** * 1,843,200)

Resolution = Sensitivity * Counter Resolution = 2.333 db/Hz * 35,000 Hz / (**ParosIntegration** * 1,843,200)

Looking at the resolution that can be obtained with a range of values for the integration time:

Integration time (ParosIntegration=)	Resolution
1 sec	0.044 m (44 mm)
2.2 sec	0.02 m (20 mm)
4.4 sec	0.01 m (10 mm)
44 sec	0.001 m (1 mm)

Continued on next page

Continued from previous page

Memory	64 Mbyte non-volatile FLASH memory	
Data Storage	<p>Recorded Parameter</p> <p>temperature + conductivity internally mounted strain gauge or Quartz pressure each external voltage SBE 63 optical dissolved oxygen SBE 38 secondary temperature SBE 50 pressure WET Labs RS-232 sensor each Pro-Oceanus GTD Aanderaa Optode date and time</p>	<p>Bytes/sample</p> <p>6 (3 each) 5 2 6 3 3 6 4 (pressure) + 3 (temperature) 3 4</p>
Real-Time Clock	32,768 Hz TCXO accurate to ± 1 minute/year.	
Internal Batteries	Nine alkaline D-cells (Duracell MN 1300, LR20; nominal capacity 14 amp-hours).	
External Power Supply (power required if not relying on internal batteries)	<p>9 - 28 VDC; current requirement varies, depending on voltage and pump:</p> <ul style="list-style-type: none"> • 3 amps at 9V input - no pump or SBE 5M pump (cannot use SBE 5P or 5T with 9V input) • 0.5 amps at 12V input – no pump or SBE 5M pump • 3 amps at 12V input – SBE 5P or 5T pump • 0.25 amps at 19V input – no pump • 0.5 amps at 19V input – SBE 5M pump • 1.5 amps at 19V input – SBE 5P or 5T pump 	
Power Requirements	<p><i>Sampling:</i> no pressure sensor 55 mA with internally mounted pressure sensor 70 mA</p> <p><i>Optional Pump:</i> SBE 5M 100 mA SBE 5P or 5T 150 mA</p> <p><i>Communications:</i> 65 mA</p> <p><i>Quiescent:</i> 20 μA</p> <p>Sampling time (see <i>Sample Timing</i> for example calculations):</p> <ul style="list-style-type: none"> • Minimum 2.2 sec/sample (no pump, no internally mounted pressure sensor, 1 measurement/sample, and no delays). • Add 0.3 sec with internally mounted strain gauge pressure sensor. • Add integration time with internally mounted Quartz pressure sensor (ParosIntegration=; minimum 1 sec). • Add 0.25 sec for each additional measurement/sample (NCycles \geq 2). • Add pump on-time (0.5 sec) if pump running before taking sample (PumpMode=1). • Add time for user-programmed delay before and after sampling (DelayBeforeSampling= and DelayAfterSampling=). <p>Approximate Battery Endurance ¹:</p> <p>CT: 355,000 samples CTD: 240,000 samples CTD & 5M pump: 140,000 samples</p> <p>¹ With Duracell MN 1300 (LR20) cells. Dependent on sampling scheme; see <i>Battery Endurance</i> for example calculations.</p>	
Auxiliary Voltage and RS-232 Sensors	<p><i>Auxiliary power out:</i> up to 500 mA at 10.5 - 11 VDC</p> <p><i>Voltage sensor A/D resolution:</i> 14 bits</p> <p><i>Voltage sensor input range:</i> 0 - 5 VDC</p>	
Housing Depth Range and Materials	<p>600 meter (1950 ft): acetal copolymer (plastic)</p> <p>7000 meter (22,900 ft): 3AL-2.5V titanium</p> <p>10,500 meter (34,400 ft): 6AL-4V titanium</p>	
Weight (without pump)	<p>With plastic housing: <i>in air</i> 7.3 kg (16 lbs)</p> <p>With 3AL-2.5V titanium housing: <i>in air</i> 13.7 kg (30 lbs)</p>	<p><i>in water</i> 2.3 kg (5 lbs)</p> <p><i>in water</i> 8.6 kg (19 lbs)</p>

Dimensions and End Cap Connectors

Dimensions in millimeters (inches)

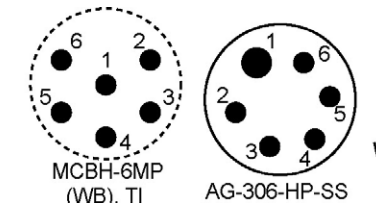
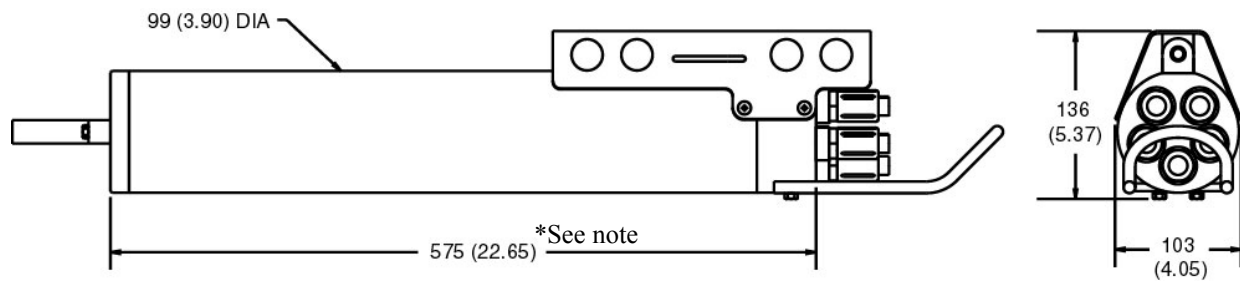
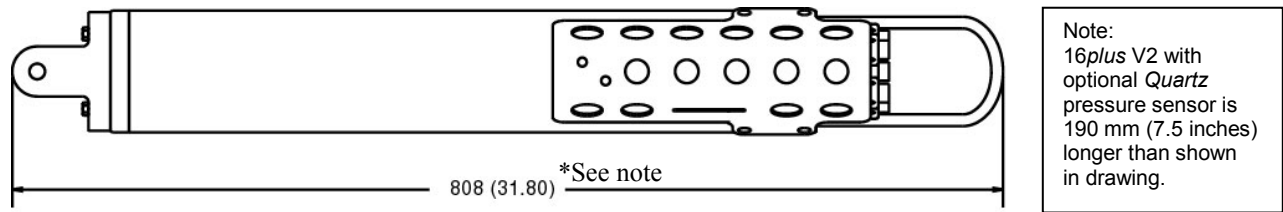

Auxiliary Differential Input 2,3

Pin	Signal
1	Common
2	Voltage 2 Signal
3	Voltage 2 Common
4	Voltage 3 Signal
5	Voltage 3 Common
6	Auxiliary Power Out

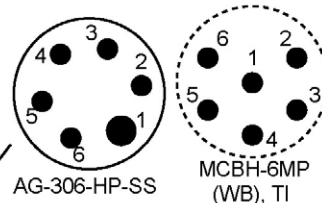
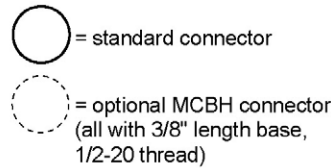

Auxiliary Differential Input 4,5

Pin	Signal
1	Common
2	Voltage 4 Signal
3	Voltage 4 Common
4	Voltage 5 Signal
5	Voltage 5 Common
6	Auxiliary Power Out

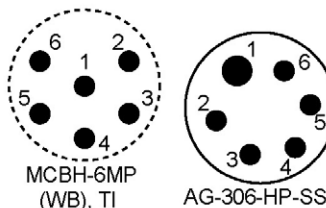

Auxiliary Differential Input 0,1

Pin	Signal
1	Common
2	Voltage 0 Signal
3	Voltage 0 Common
4	Voltage 1 Signal
5	Voltage 1 Common
6	Auxiliary Power Out

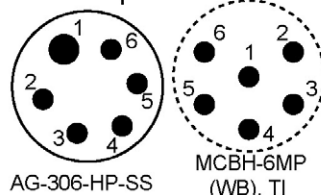
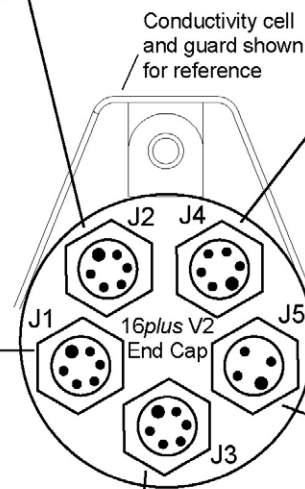

Data I/O, Pump, and External Power

Pin	Signal
1	Common
2	RS-232 data receive
3	RS-232 data transmit
4	Pump power common
5	Pump power
6	Auxiliary power in (9-28 VDC)

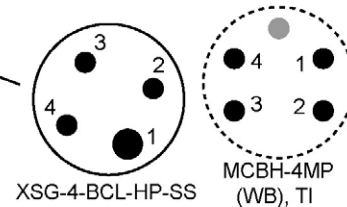

Auxiliary RS-232 Input

Pin	Signal
1	Common
2	RS-232 Data transmit to RS-232 sensor
3	RS-232 Data receive from RS-232 sensor
4	Power to RS-232 sensor

Note: RS-232 sensor must be set to same baud rate as 16plus V2.

Note:
Y-cable from this connector connects to pump and data I/O - power cable.
If configured without pump, 6-pin to 4-pin extender cable from this connector connects to data I/O - power cable.

Cables

6-pin to 4-pin extension cable
(16plus V2 without pump) –
6-pin connects to 16plus V2 bulkhead connector;
4-pin connects to data I/O cable

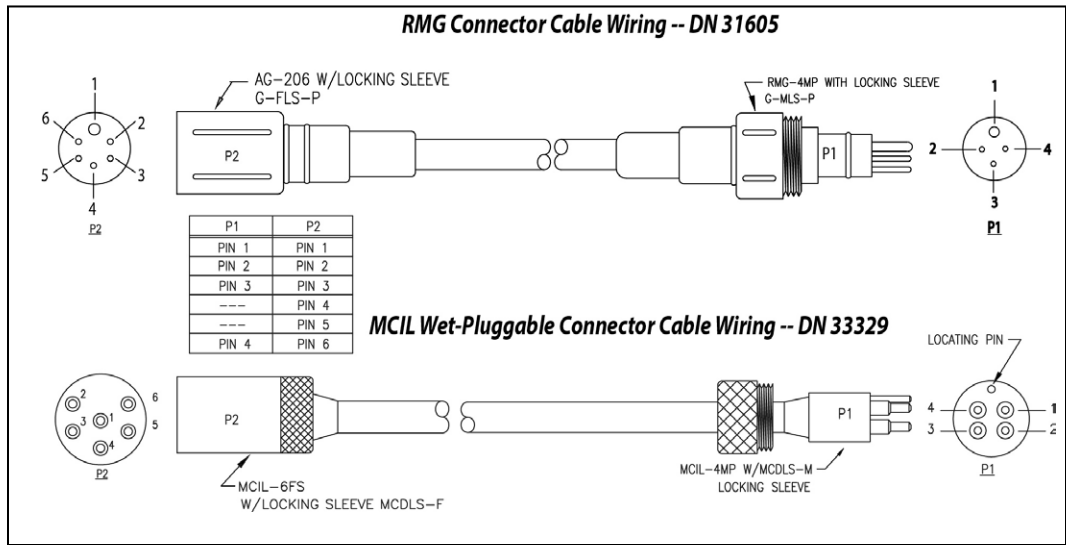

Y- cable (16plus V2 with pump) –
6-pin connects to 16plus V2 bulkhead connector;
2-pin connects to pump;
4-pin connects to data I/O cable

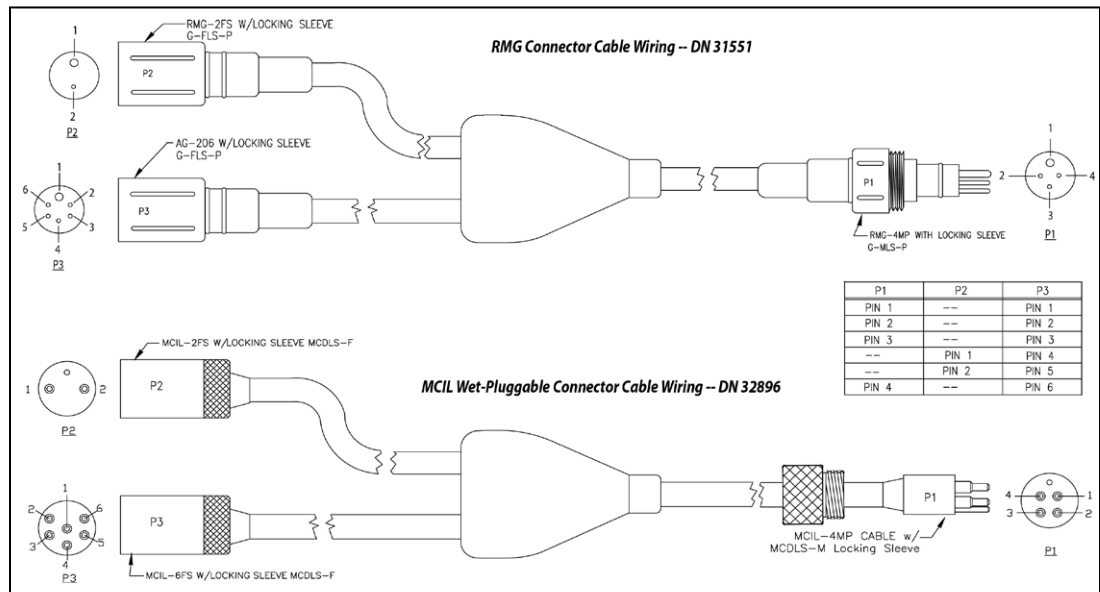

Data I/O cable

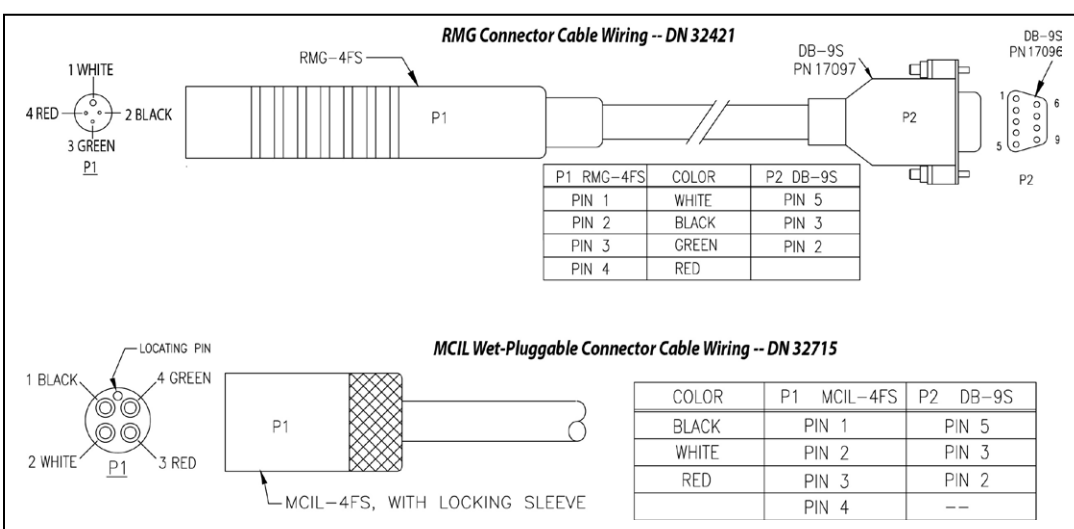

Data I/O

The SBE 16plus V2 receives setup instructions and outputs diagnostic information or previously recorded data via a three-wire RS-232C link, and is factory-configured for 9600 baud, 8 data bits, 1 stop bit, and no parity. SBE 16plus V2 RS-232 levels are directly compatible with standard serial interface cards (IBM Asynchronous Communications Adapter or equal). The communications baud rate can be changed using **BaudRate=** (see *Command Descriptions* in *Section 4: Deploying and Operating SBE 16plus V2*).

Data Storage

Note:
See *Battery Endurance* for power limitations.

The SBE 16plus V2 has a 64 Mbyte FLASH memory. If the memory is filled to capacity, data sampling and transmission of real-time data (if programmed) continue, but excess data is not saved in memory.

Shown below are examples of available data storage for several configurations. See *Specifications* for storage space required for each parameter.

Example 1: internally mounted strain gauge pressure and no auxiliary sensors
 T & C = 6 bytes/sample
 Internally mounted strain gauge P = 5 bytes/sample
 Date/Time = 4 bytes/sample
 Storage space $\approx 64,000,000 / (6 + 5 + 4) \approx 4,266,000$ samples

Example 2: internally mounted Quartz pressure, 6 external voltages, and SBE 38 secondary temperature sensor
 T & C = 6 bytes/sample
 Internally mounted Quartz P = 5 bytes/sample
 External voltages = 2 bytes/sample * 6 voltages = 12 bytes/sample
 SBE 38 = 3 bytes/sample
 Date/Time = 4 bytes/sample
 Storage space $\approx 64,000,000 / (6 + 5 + 12 + 3 + 4) \approx 2,133,000$ samples

Sample Timing

Notes:

- See sampling times in *Specifications*.
- Sample timing information is approximate.
- See *Battery Endurance* for power limitations.
- If transmitting real-time data, you must also account for the data transmission time. See *Real-Time Setup* in *Section 4: Deploying and Operating SBE 16plus V2*.

Sample timing is dependent on a number of factors, including whether the 16plus V2 has an optional pressure sensor and the pressure sensor type – strain gauge or Quartz, setup for a Quartz pressure sensor (**ParosIntegration=**), setup for the optional pump (**PumpMode=**), and user-programmable sampling parameters for number of samples per measurement (**NCycles=**), delay before sampling to allow time for auxiliary sensors to stabilize or for WET Labs auxiliary sensor bio-wipers to open (**DelayBeforeSampling=**), and delay after sampling to allow time for WET Labs auxiliary sensor bio-wipers to close (**DelayAfterSampling=**).

For autonomous sampling (logging), the 16plus V2 requires a minimum of 5 sec from the end of one sample to the beginning of the next sample. After it takes each sample, it checks the time for the start of the next sample, based on the user-programmable sampling interval (**SampleInterval=**). If there is less than 5 sec remaining until the programmed start of the next sample, the 16plus V2 provides a message:

```
Error - - > alarm time not far enough in the future,
resetting alarm to 5 sec from now
```

The 16plus V2 takes the next sample in 5 sec. The 16plus V2 performs this check after each sample; because of small variations in sampling time, this can cause samples to be taken at uneven intervals. Therefore, best practice is to check the sample timing before you set up the instrument, to ensure that the sample interval is long enough.

Examples are shown below:

Example 1 - pump on for 0.5 sec before each sample (**PumpMode=1**), no internally mounted pressure sensor, 1 measurement/sample (**NCycles=1**):

Sampling time = 0.5 sec (pump before sampling) + 2.2 sec (basic sampling time) = 2.7 sec
 Minimum sample interval (**SampleInterval=**) = 2.7 sec + 5 (sec between samples) = 7.7 sec < 10 sec minimum,
 so **minimum SampleInterval=10**.

Example 2 - pump on during sample (**PumpMode=2**), 15 sec delay before sampling (**DelayBeforeSampling=15**), internally mounted Quartz pressure sensor integrating for 3 sec/sample (**ParosIntegration=3**), and 4 measurements/sample (**NCycles=4**):

Sampling time = 15 (delay before sampling) + 2.2 (basic sampling time) + 3 (Quartz integration) +
 (4 – 1) * 0.25 (additional measurements/sample for **NCycles**) = 20.95 sec
 Minimum sample interval (**SampleInterval=**) = 20.95 sec + 5 (sec between samples) = 25.95 sec,
 so **minimum SampleInterval=28** (round up by a few seconds, to account for any small differences in sample timing).

Batteries

Note:

The lithium battery pack cannot be used with a 16plus V2 that is integrated with an SBE 5T or 5P pump.

For the main battery, the SBE 16plus V2 uses nine D-cell alkaline batteries (Duracell MN 1300, LR20). An optional battery pack kit for lithium batteries is available (lithium batteries **not** supplied by Sea-Bird).

On-board lithium batteries (non-hazardous units which are unrestricted for shipping purposes) are provided to back-up the buffer and the real-time clock in the event of main battery failure or exhaustion. The main batteries may be replaced without affecting either the real-time clock or memory.

Battery Endurance

Notes:

- See sampling times and power consumption in *Specifications*.
- If the 16plus V2 is logging data and the battery voltage is less than 7.5 volts, the 16plus V2 halts logging and displays a low battery indication in the data.
- See *Data Storage and Specifications* for data storage limitations.

The standard alkaline battery pack has a nominal capacity of 14 amp-hours. For planning purposes, Sea-Bird recommends using a conservative value of:

- 12.2 amp-hours for a 16plus V2 with no pump or auxiliary sensors
- 10.5 amp-hours for a 16plus V2 drawing more current because of optional pump and/or auxiliary sensors

Current consumption and sampling times vary greatly, depending on the instrument configuration (inclusion of pressure sensor, pump, and/or auxiliary sensors) as well as user-programmed sampling parameters (pump operating mode, number of measurements per sample, delay before sampling, quartz pressure sensor integration time). Examples are shown below for several sampling schemes. **You can use the Deployment Endurance Calculator** to determine the maximum deployment length, instead of performing the calculations by hand.

A 16plus V2 with standard alkaline batteries is set up to sample autonomously every 10 minutes (6 samples/hour). How long can it be deployed?

Example 1 – no pump, internally mounted pressure sensor, or auxiliary sensors; 1 measurement/sample (**NCycles=1**):

Sampling current = 55 mA * 2.2 sec = 0.12 amp-sec/sample
In 1 hour, sampling current = 6 * 0.12 amp-sec/sample = 0.72 amp-sec/hour

Quiescent current = 20 microamps = 0.02 mA
In 1 hour, quiescent current ≈ 0.02 mA * 3600 sec/hour = 0.072 amp-sec/hour

Current consumption / hour = 0.72 + 0.072 = 0.792 amp-sec/hour
Capacity = (12.2 amp-hours * 3600 sec/hr) / (0.792 amp-sec/hour) = 55454 hours = 2310 days = 6.3 years

However, Sea-Bird recommends that batteries should not be expected to last longer than 2 years in the field.

Example 2 - with 5M pump on for 0.5 sec/sample (**PumpMode=1**), no internally mounted pressure sensor or auxiliary sensors, 1 measurement/sample (**NCycles=1**):

Sampling current = 55 mA * (2.2 sec + 0.5 sec) = 0.148 amp-sec/sample
In 1 hour, sampling current = 6 * 0.148 amp-sec/sample = 0.89 amp-sec/hour

Pump current = 100 mA * 0.5 sec = 0.05 amp-sec/sample
In 1 hour, pump current = 6 * 0.05 amp-sec/sample = 0.30 amp-sec/hour

Quiescent current = 20 microamps = 0.02 mA
In 1 hour, quiescent current ≈ 0.02 mA * 3600 sec/hour = 0.072 amp-sec/hour

Current consumption / hour = 0.89 + 0.30 + 0.072 = 1.26 amp-sec/hour
Capacity = (10.5 amp-hours * 3600 sec/hr) / (1.26 amp-sec/hour) = 30000 hours = 1250 days = 3.4 years

However, Sea-Bird recommends that batteries should not be expected to last longer than 2 years in the field.

Example 3 - with 5T pump on during sample (**PumpMode=2**), 15 sec delay before sampling (**DelayBeforeSampling=15**), internally mounted Quartz pressure sensor integrating for 3 sec/sample (**ParosIntegration=3**), auxiliary sensors drawing 100 mA, 4 measurements/sample (**NCycles=4**):

On-time = 2.2 + 3 (Quartz integration) + 15 (delay before sampling) + (4 – 1) * 0.25 (additional measurements/sample)
= 20.95 sec

Sampling current = 70 mA * 20.95 sec = 1.47 amp-sec/sample
In 1 hour, sampling current = 6 * 1.47 amp-sec/sample = 8.8 amp-sec/hour

5T Pump current = 150 mA * 20.95 sec = 3.14 amp-sec/sample
In 1 hour, pump current = 6 * 3.14 amp-sec/sample = 18.9 amp-sec/hour

Auxiliary sensor current = 100 mA * 20.95 sec = 2.10 amp-sec/sample
In 1 hour, auxiliary sensor current = 6 * 2.10 amp-sec/sample = 12.6 amp-sec/hour

Quiescent current = 20 microamps = 0.02 mA
In 1 hour, quiescent current ≈ 0.02 mA * 3600 sec/hour = 0.072 amp-sec/hour

Current consumption / hour = 8.8 + 18.9 + 12.6 + 0.072 = 40.4 amp-sec/hour
Capacity = (10.5 amp-hours * 3600 sec/hr) / (40.4 amp-sec/hour) = 935 hours = 38 days = 0.1 years

External Power

The SBE 16plus V2 can be powered from an external source (9 - 28 volts DC) through the extender cable or Y-cable connected to the Data I/O, Pump, and External Power bulkhead connector on the sensor end cap. The internal battery pack is diode-OR'd with the external source, so power will be drawn from whichever voltage source is higher. The 16plus V2 can also be operated from the external supply without having the internal battery pack installed. Electrical isolation of conductivity is retained in units powered externally, preventing ground loop noise contamination in the conductivity measurement.

Cable Length and External Power

Note:

See *Real-Time Setup* in *Section 4: Deploying and Operating SBE 16plus V2* for baud rate limitations on cable length if transmitting real-time data.

There are two issues to consider if powering the SBE 16plus V2 externally:

- Limiting the communication IR loss to 1 volt **if transmitting real-time data**; higher IR loss will cause the instrument to transmit data that does not meet the RS-232 communication standard.
- Supplying enough power at the power source so that sufficient power is available at the instrument after considering IR loss.

Each issue is discussed below.

Limiting Communication IR Loss to 1 Volt if Transmitting Real-Time Data

The limit to cable length is typically reached when the maximum current during **communication** times the power common wire resistance is more than 1 volt.

$$V_{\text{limit}} = 1 \text{ volt} = IR_{\text{limit}}$$

$$\text{Maximum cable length} = R_{\text{limit}} / \text{wire resistance per foot}$$

where I = communication current required by SBE 16plus V2 (65 milliamps; see *Specifications*).

Note:

Common wire resistances:

Gauge	Resistance (ohms/foot)
12	0.0016
14	0.0025
16	0.0040
18	0.0064
19	0.0081
20	0.0107
22	0.0162
24	0.0257
26	0.0410
28	0.0653

Example 1 – For 20 gauge wire, what is maximum distance to transmit power to 16plus V2 if transmitting real-time data?

For 65 milliamp communications current, $R_{\text{limit}} = V_{\text{limit}} / I = 1 \text{ volt} / 0.065 \text{ amps} = 15.4 \text{ ohms}$

For 20 gauge wire, resistance is 0.0107 ohms/foot.

Maximum cable length = $15.4 \text{ ohms} / 0.0107 \text{ ohms/foot} = 1439 \text{ feet} = 439 \text{ meters}$

Example 2 – Same as above, but there are 4 instruments powered from the same power supply.

For 65 milliamp communications current, $R_{\text{limit}} = V_{\text{limit}} / I = 1 \text{ volt} / (0.065 \text{ amps} * 4 \text{ instruments}) = 3.8 \text{ ohms}$

Maximum cable length = $3.8 \text{ ohms} / 0.0107 \text{ ohms/foot} = 355 \text{ feet} = 108 \text{ meters}$ (to 16plus V2 furthest from power source).

Supplying Enough Power to SBE 16plus V2

Another consideration in determining maximum cable length is supplying enough power at the power source so that sufficient voltage is available, after IR loss in the cable (*from the turn-on transient, two-way resistance*), to power the SBE 16plus V2. The table summarizes the maximum 2-way resistance for various input supplies and pump configurations:

Power Supply Input and Pump Configuration	$R_{\text{limit}} = \text{Maximum 2-way Resistance (ohms)}$
3 amps at 9V input, no pump or SBE 5M pump (cannot use SBE 5P or 5T with 9V input)	1
0.5 amps at 12V input, no pump	50
0.5 amps at 12V input, SBE 5M pump	10
3.0 amps at 12V input, SBE 5P or 5T pump	2
0.25 amps at 19V input, no pump	150
0.5 amps at 19V input, SBE 5M pump	30
1.5 amps at 19V input, SBE 5P or 5T pump	7

Calculate maximum cable length as:

$$\text{Maximum cable length} = R_{\text{limit}} / 2 * \text{wire resistance per foot}$$

Example 1 – For 20 gauge wire, what is maximum distance to transmit power to 16plus V2 if using 12 volt power source with SBE 5T pump?

Maximum cable length = $R_{\text{limit}} / 2 * \text{wire resistance per foot} = 2 \text{ ohms} / 2 * 0.0107 \text{ ohms/foot} = 93 \text{ ft} = 28 \text{ meters}$

Note that 28 meters < 474 meters (maximum distance if 16plus V2 is transmitting real-time data), so IR drop in power is controlling factor for this example. Using a higher voltage power supply or a different wire gauge would increase allowable cable length.

Example 2 – Same as above, but there are 4 instruments powered from same power supply.

Maximum cable length = $R_{\text{limit}} / 2 * \text{wire resistance per foot} * 4 \text{ instruments}$
 $= 2 \text{ ohms} / 2 * 0.0107 \text{ ohms/foot} * 4 = 23 \text{ ft} = 7 \text{ meters (to 16plus V2 furthest from power source)}$

Configuration Options and Plumbing

The SBE 16*plus* V2 is available with an optional, externally mounted, submersible pump. The pump is required for a 16*plus* V2 configured with an optional dissolved oxygen sensor or pumped fluorometer, but also provides the following benefits for conductivity data:

- Improved conductivity response - The pump flushes the previously sampled water from the conductivity cell and brings a new water sample quickly into the cell.
- Improved anti-foulant protection - Water does not freely flow through the conductivity cell between samples, allowing the anti-foulant concentration inside the cell to build up.

Several pump models are available:

- SBE 5M miniature pump (available in plastic or titanium) - for pumped conductivity.
- SBE 5P (plastic) or 5T (titanium) pump - a more powerful pump for use if the 16*plus* V2 is configured with a dissolved oxygen sensor and/or pumped fluorometer.

In all cases, the pump is powered via a cable connected to the 2-pin leg of a Y-cable (which is connected to the Data I/O, Pump, and External Power bulkhead connector on the sensor end cap).

The SBE 16*plus* V2 can be configured with a wide range of auxiliary sensors. Three standard 6-pin bulkhead connectors on the sensor end cap serve as the input ports for the auxiliary sensor signal voltages and provide power to the sensors.

Additionally, a standard 4-pin bulkhead connector on the sensor end cap is provided for interfacing with one of the following RS-232 sensors:

- SBE 63 optical dissolved oxygen sensor
- SBE 38 secondary temperature sensor
- SBE 50 secondary strain-gauge pressure sensor
- WET Labs sensor - single, dual, or triple channel ECO sensor; WETStar; or C-Star
- Pro-Oceanus Gas Tension Devices (up to two GTDs can be integrated)
- Aanderaa Optode 4330 or 4835

Shown below is the plumbing arrangement of an SBE 16plus V2 equipped with a pump and the optional SBE 43 Dissolved Oxygen sensor. See *Section 4: Deploying and Operating SBE 16plus V2* for pump setup and operation details.

- Main plumbing is 13 mm ID x 19 mm OD (1/2 inch x 3/4 inch) Tygon tubing.
- A 13 mm (0.5 inch) long piece of 9.5 mm ID x 13 mm OD (3/8 inch x 1/2 inch) Tygon tubing to fit to the main plumbing is installed:
 - on the conductivity cell exhaust, and
 - on the SBE 43 intake and exhaust

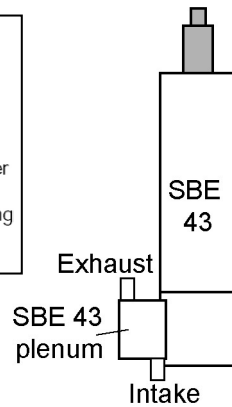
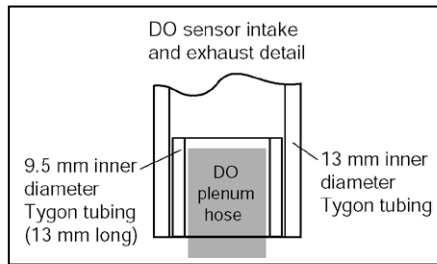

Place DO sensor with plenum intake closer than exhaust to SBE 43 housing, as shown.

Note: SBE 43 housing orientation (connector end up or down) does not affect operation. Plenum can be reversed on housing by removing and replacing 2 screws.

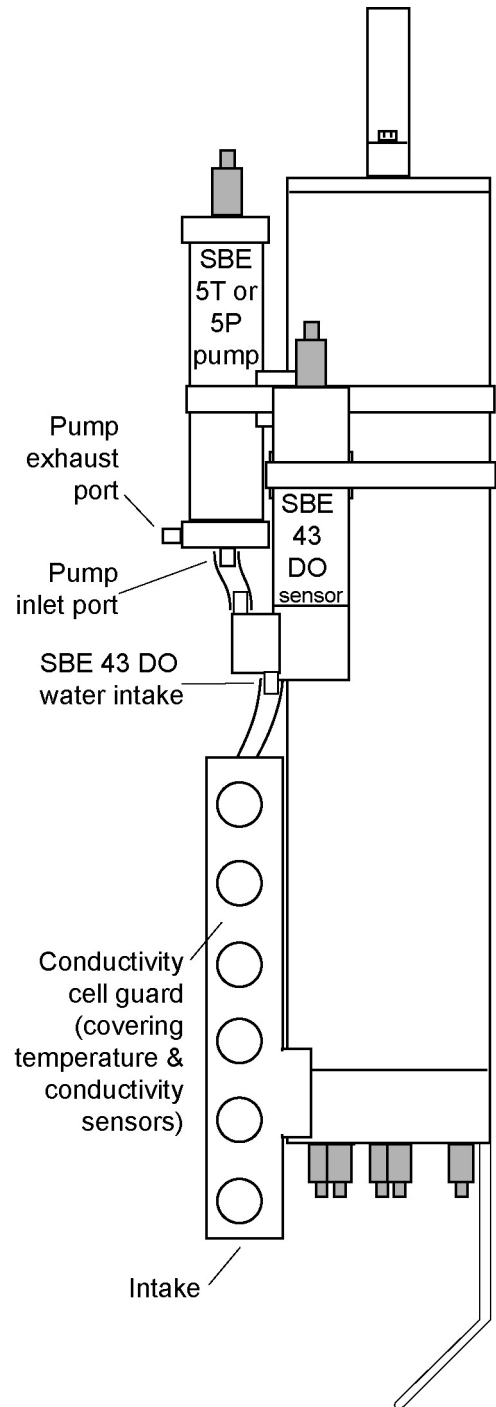

Section 3:

Power and Communications Test

This section describes installing software and the pre-check procedure for preparing the SBE 16plus V2 for deployment. The power and communications test will verify that the system works, prior to deployment.

Software Installation

Notes:

- Help files provide detailed information on the software. Separate software manuals on the CD-ROM contain detailed information on Seasave V7 and SBE Data Processing.
- Sea-Bird also supplies an older version of Seasave, Seasave-Win32. However, Seasave-Win32 is not compatible with the 16plus V2.
- It is possible to use the 16plus V2 without the SeatermV2 terminal program by sending direct commands from a dumb terminal or terminal emulator, such as Windows HyperTerminal.
- Sea-Bird supplies the current version of our software when you purchase an instrument. As software revisions occur, we post the revised software on our FTP site. See our website (www.seabird.com) for the latest software version number, a description of the software changes, and instructions for downloading the software from the FTP site.

Sea-Bird recommends the following minimum system requirements for installing the software: Windows 2000 or later, 630 MHz processor, 256 MB RAM, and 90 MB free disk space for installation. Although Seasoft V2 was designed to work with a PC running Win 2000/XP; extensive testing has not shown any compatibility problems when using the software with a PC running Windows Vista or Windows 7 (32-bit).

If not already installed, install Sea-Bird software programs on your computer using the supplied software CD:

1. Insert the CD in your CD drive.
2. Install software: Double click on **SeasoftV2_date.exe** (*date* is the date that version of the software was created). Follow the dialog box directions to install the software. The installation program allows you to install the desired components. Install all the components, or just install Deployment Endurance Calculator (battery endurance calculator), SeatermV2 (terminal program *launcher* for the 16plus V2), Seasave V7 (real-time data acquisition), SBE Data Processing (data processing), and Seaterm (terminal program for setting up SBE 38 or SBE 50 auxiliary sensors, if applicable to your system).

The default location for the software is c:\Program Files\Sea-Bird. Within that folder is a sub-directory for each program.

Test Setup

Note:

The cable connected to the Data I/O, Pump, and External Power connector on the 16plus V2 end cap is dependent on whether the 16plus V2 is configured with a pump:

- When configured without a pump, a 6-pin to 4-pin extender cable provides communications with the computer via the 4-pin connector.
- When configured with a pump, a Y-cable provides power to the pump via the 2-pin connector as well as communications with the computer via the 4-pin connector.

1. Remove the dummy plug and install the I/O cable:
 - A. Pulling the plug firmly away from the connector, remove the dummy plug from the 4-pin connector on the extender cable or Y-cable strapped to the 16plus V2 housing.
 - B. **Standard Connector** - Install the I/O cable connector, aligning the raised bump on the side of the connector with the large pin (pin 1 - ground) on the extender cable or Y-cable. **OR** **MCBH Connector** - Install the I/O cable connector, aligning the pins.
2. Connect the I/O cable connector to your computer's serial port.

Note:

Y-cable from this connector connects to pump and data I/O - power cable. If configured without pump, 6-pin to 4-pin extender cable from this connector connects to data I/O - power cable.

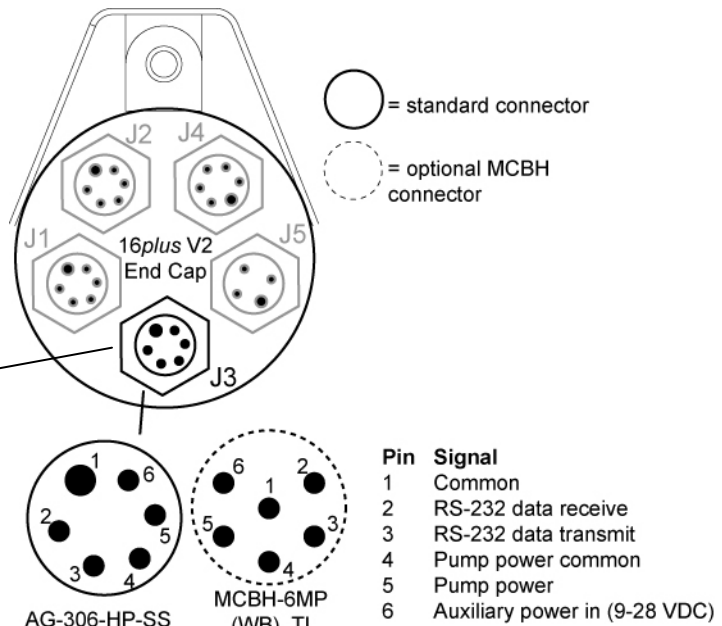

Data I/O, Pump, and External Power

Test

Note:
See SeatermV2's Help files.

1. Double click on **SeatermV2.exe**. The main screen looks like this:

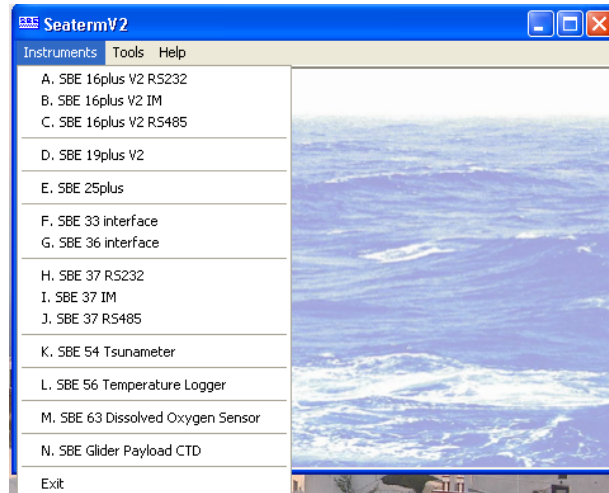

SeatermV2 is a *launcher*. Depending on the instrument selected, it launches Seaterm232 (RS-232 instruments), Seaterm485 (RS-485 instruments), or SeatermIM (inductive modem instruments).

Note:
See Seaterm232's Help files.

2. In the Instruments menu, select *SBE 16plus V2 RS232*. **Seaterm232** opens; the main screen looks like this:

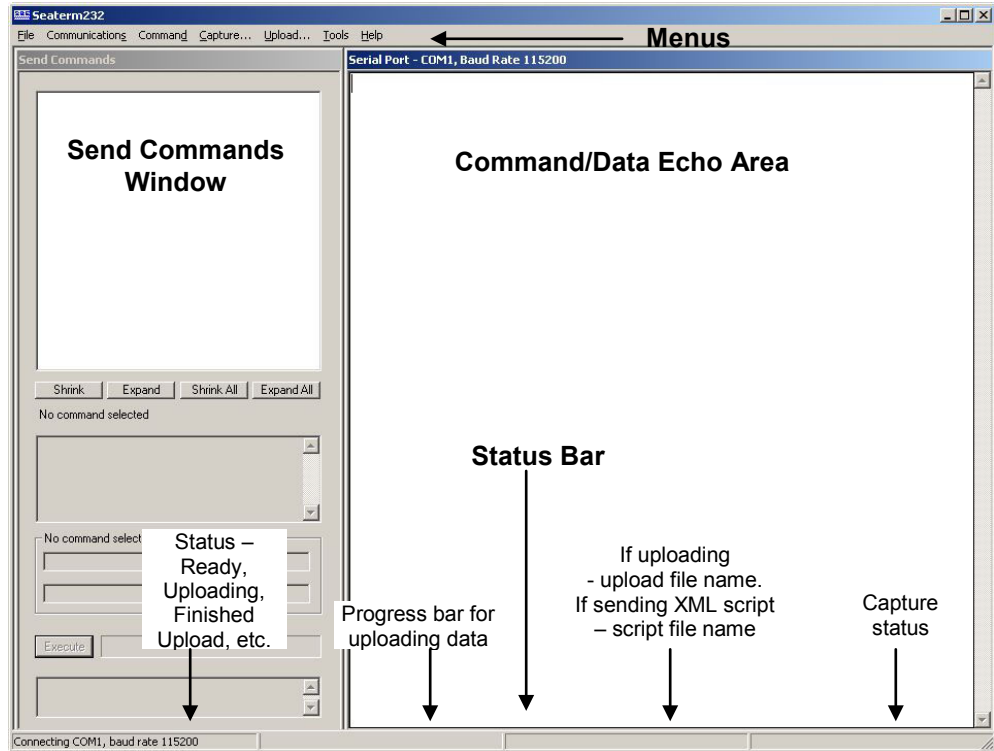

- Menus – For tasks and frequently executed instrument commands.
- Send Commands window – Contains commands applicable to your 16plus V2. The list appears after you connect to the 16plus V2.
- Command/Data Echo Area – Title bar of this window shows Seaterm232's current comm port and baud rate. Commands and the 16plus V2 responses are echoed here. Additionally, a command can be manually typed or pasted (ctrl + V) here. Note that the 16plus V2 must be *connected* and *awake* for it to respond to a command.
- Status bar – Provides connection, upload, script, and capture status information.

Following is a description of the menus:

Menu	Description	Equivalent Command*
File	<ul style="list-style-type: none"> • Load command file – opens selected .XML command file, and fills Send Commands window with commands • Unload command file – closes command file, and removes commands from Send Commands window • Exit - Exit program. 	-
Communications	<ul style="list-style-type: none"> • Connect – connect to comm port • Disconnect – disconnect from comm port • Configure – Establish communication parameters (comm port and baud rate). • Disconnect and reconnect – may be useful if 16plus V2 has stopped responding 	-
Command	<ul style="list-style-type: none"> • Abort – interrupt and stop 16plus V2's response • Send 5 second break (for use with Serial Line Sync mode) • Send stop command • Set local time– Set date and time to time sent by timekeeping software on your computer; accuracy ± 25 msec of time provided by computer. • Set UTC Time (Greenwich Mean Time) – Set date and time to time sent by timekeeping software on your computer; accuracy ± 25 msec of time provided by computer. 	<ul style="list-style-type: none"> • (press Esc key several times for Abort) • Stop • DateTime= • DateTime=
Capture	Capture 16plus V2 responses on screen to file, to save real-time data or use for diagnostics. File has .cap extension. Click Capture again to turn off capture. Capture status displays in Status bar.	—
Upload	Upload data stored in memory, in format Sea-Bird's data processing software can use (raw hex). Uploaded data has .xml extension, and is then automatically converted to a file with .hex extension. Before using Upload: stop logging by sending Stop .	Several status commands and appropriate data upload command as applicable to user selection of range of data to upload (use Upload menu if you will be processing data with SBE Data Processing or viewing archived data with Seasave)
Tools	<ul style="list-style-type: none"> • Diagnostics log - Keep a diagnostics log. • Convert .XML data file – Using Upload menu automatically does this conversion; tool is available if there was a problem with the automatic conversion. • Send script – Send XML script to 16plus V2. May be useful if you have a number of 16plus V2s to program with same setup. 	-

Note:

Set local time and Set UTC time are disabled if the baud rate in Seaterm232 is set to 115200, because the software cannot reliably set the time at that baud.

*See Command Descriptions in Section 4: Deploying and Operating SBE 16plus V2.

3. If this is the first time Seaterm232 is being used, the Serial Port Configuration dialog box displays:

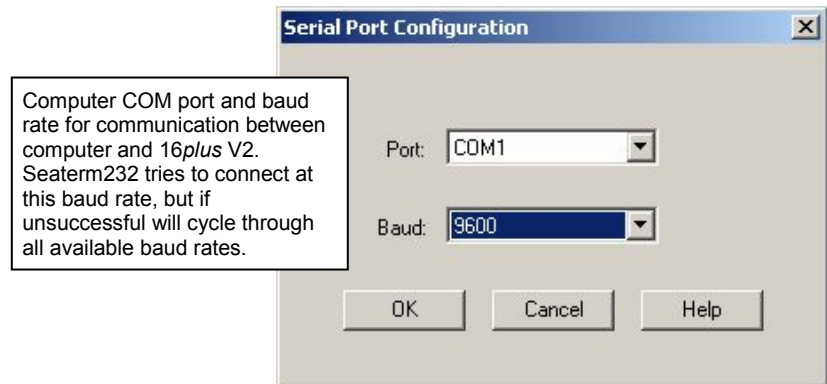

Make the desired selections, and click OK.

Note:

Seaterm232's baud rate must be the same as the 16plus V2 baud rate (set with **BaudRate=**). Baud is factory-set to 9600, but can be changed by the user (see *Command Descriptions* in *Section 4: Deploying and Operating SBE 16plus V2*). Other communication parameters – 8 data bits, 1 stop bit, and no parity – cannot be changed.

Note:

If **OutputExecutedTag=Y**, the 16plus V2 does **not** provide an S> prompt after the <Executed/> tag at the end of a command response.

4. Seaterm232 tries to automatically connect to the 16plus V2. As it connects, it sends **GetHD** and displays the response, which provides factory-set data such as instrument type, serial number, and firmware version. Seaterm232 also fills the Send Commands window with the correct list of commands for your 16plus V2.

If there is no communication:

- A. In the Communications menu, select *Configure*. The Serial Port Configuration dialog box appears. Select the Comm port and baud rate for communication, and click OK. Note that the factory-set baud rate is documented on the Configuration Sheet. .
- B. In the Communications menu, select *Connect* (if *Connect* is grayed out, select *Disconnect and reconnect*). Seaterm232 will attempt to connect at the baud specified in Step A, but if unsuccessful will then cycle through all other available baud rates.
- C. If there is still no communication, check cabling between the computer and 16plus V2, and try to connect again.
- D. If there is still no communication, repeat Step A with a different comm port, and try to connect again.

After Seaterm232 displays the **GetHD** response, it provides an S> prompt to indicate it is ready for the next command.

Taking a look at the Send Commands window:

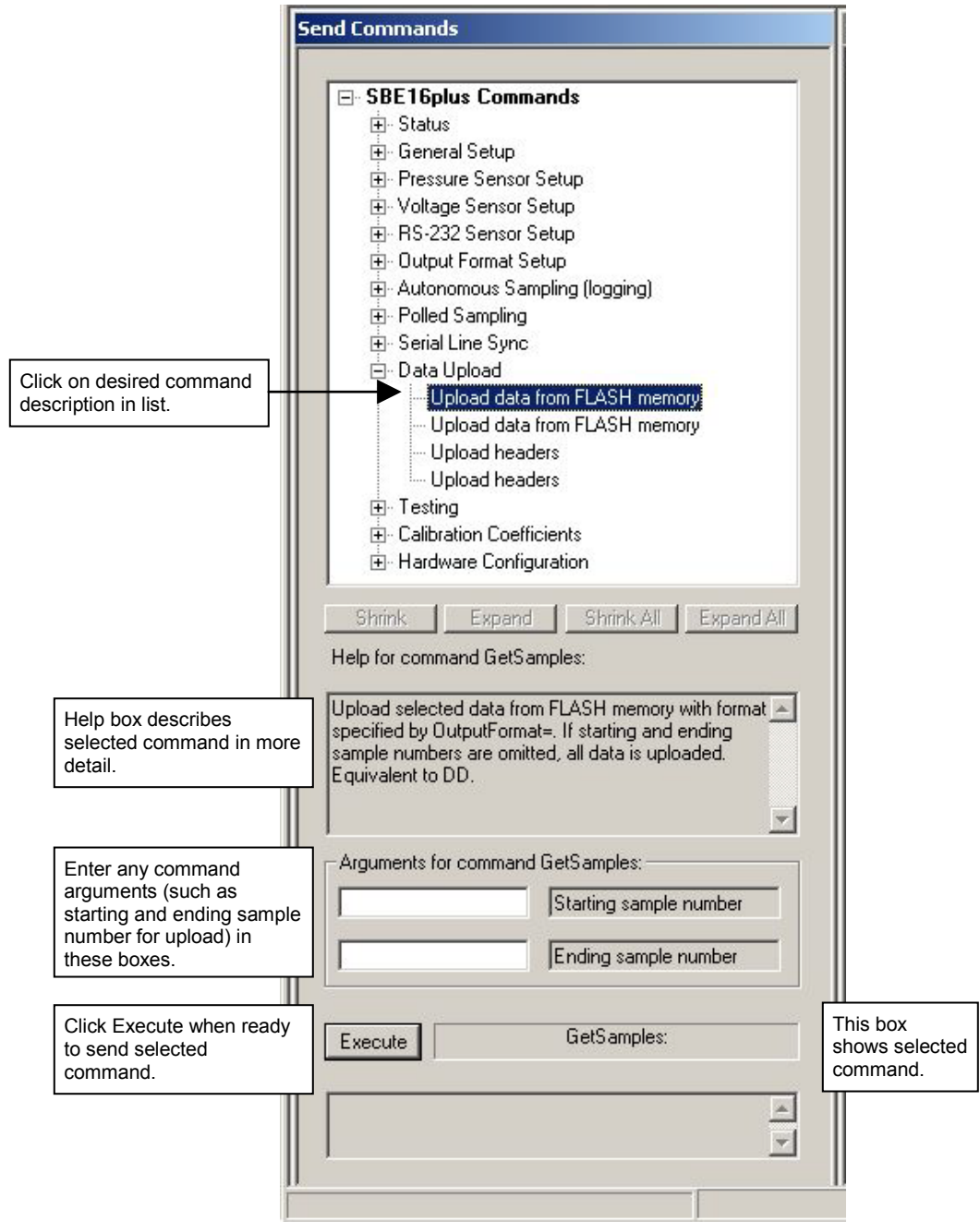

You can use the Send Commands window to send commands, or simply type the commands in the Command/Data Echo area if desired.

5. Display 16plus V2 status information by typing **DS** and pressing the Enter key. The display looks like this:

```
SBE 16plus V 2.5 SERIAL NO. 6001 12 May 2012 14:11:48
vbatt = 10.3, vlith = 8.5, ioper = 62.5 ma, ipump = 21.6 ma,
iext01 = 76.2 ma
status = not logging
samples = 0, free = 3463060
sample interval = 15 seconds, number of measurements per sample = 1
pump = run pump during sample, delay before sampling = 2.0 seconds,
delay after sampling = 0.0 seconds
transmit real-time = yes
battery cutoff = 7.5 volts
pressure sensor = strain gauge, range = 1000.0
SBE 38 = no, SBE 50 = no, WETLABS = no, OPTODE = no, SBE63 = no,
Gas Tension Device = no
Ext Volt 0 = yes, Ext Volt 1 = yes
Ext Volt 2 = no, Ext Volt 3 = no
Ext Volt 4 = no, Ext Volt 5 = no
echo characters = yes
output format = converted decimal
output salinity = no, output sound velocity = no
serial sync mode disabled
```

Notes:

- The 16plus V2 automatically enters quiescent (sleep) state after 2 minutes without receiving a command. This timeout algorithm is designed to conserve battery energy if the user does not send **QS** to put the 16plus V2 to sleep. If the system does not appear to respond, click Connect in the Communications menu to reestablish communications.
- Sending the status command causes the optional pump to turn on for a moment, so that the 16plus V2 can measure and output the pump current. Because the pump is designed to be water lubricated, you may hear a noise when the impeller spins in air. Running the pump *dry* for **short** periods (for example, when sending the status command) will not harm the pump.

6. Command the 16plus V2 to take a sample by typing **TS** and pressing the Enter key. The display looks like this (if 16plus V2 includes optional internally mounted pressure sensor, and is set up for converted decimal output format, no output salinity or sound velocity, and auxiliary voltage sensors on channels 0 and 1):

```
23.7658, 0.00019, 0.062, 0.5632, 2.3748, 12 Feb 2012, 14:11:60
```

where

- 23.7658 = temperature in degrees Celsius
- 0.00019 = conductivity in S/m
- 0.062 = pressure in db
- 0.5632 = voltage for auxiliary sensor channel 0
- 2.3748 = voltage for auxiliary sensor channel 1
- 12 Feb 2012 = date
- 14:11:60 = time

These numbers should be reasonable; i.e., room temperature, zero conductivity, barometric pressure (gauge pressure), current date and time (set at factory to Pacific Daylight or Standard Time).

7. Command the 16plus V2 to go to sleep (quiescent state) by typing **QS** and pressing the Enter key.

The SBE 16plus V2 is ready for programming and deployment.

Section 4:

Deploying and Operating SBE 16plus V2

This section includes discussions of:

- Sampling modes, including example sets of commands
- Pump operation
- Real-time setup
- Timeout description
- Command descriptions
- Data output formats
- Deployment
- Acquiring real-time data with Seasave
- Recovery - physical handling and uploading data
- Processing data with SBE Data Processing
- Editing a raw data file

Note:

Separate software manuals and Help files contain detailed information on installation, setup, and use of Sea-Bird's software.

Sampling Modes

The SBE 16plus V2 has three basic sampling modes for obtaining data:

- Polled Sampling
- Autonomous Sampling
- Serial Line Synchronization

Commands can be used in various combinations to provide a high degree of operating flexibility.

Descriptions and examples of the sampling modes follow. Note that the SBE 16plus V2 response to each command is not shown in the examples. Review the operation of the basic sampling modes and the commands described in *Command Descriptions* before setting up your system.

Note:

The 16plus V2 automatically enters quiescent state after 2 minutes without receiving a command.

Polled Sampling

On command, the SBE 16plus V2 takes one sample of data and sends the data to the computer. Storing of data in the 16plus V2 FLASH memory is dependent on the particular command used.

Example: Polled Sampling (user input in bold)

Wake up 16plus V2. Set date and time to November 1, 2012 at 9:05 am. Set up with 1 voltage sensor, no pump, take and average 4 measurements for each sample, and output data in converted decimal format. After all parameters are entered, verify setup. Command 16plus V2 to take a sample, and send data to computer (do not store data in memory). Send power-off command.

(Click Connect in Seaterm232's Communications menu to connect and wake up.)

DATE**TIME=11012012090500**

VOLT0=Y

PUMPMODE=0

NCYCLES=4

OUTPUTFORMAT=3

GETCD (to verify setup)

TS

QS

Autonomous Sampling (logging)

Note:

Set **OutputFormat=0** if you will be using Sea-Bird's real-time data acquisition software (Seasave).

At pre-programmed intervals, the SBE 16plus V2 wakes up, samples data, stores the data in its FLASH memory, and enters quiescent (sleep) state. The 16plus V2 goes to sleep for a minimum of 5 sec between each sample. Logging is started with **StartNow** or **StartLater**, and is stopped with **Stop**. If real-time data is to be transmitted (**TxRealTime=Y**), data is transmitted after measurements are complete for that sample and before sampling begins for the next sample.

Note:

Use **Stop** to:

- Stop autonomous sampling
- Stop waiting to start autonomous sampling (after **Startlater** has been sent)

Once **Stop** is sent, the 16plus V2 accepts all commands again.

The 16plus V2 has a *lockout* feature to prevent unintended interference with sampling. If the 16plus V2 is sampling or is waiting to start sampling (**StartLater** has been sent, but logging hasn't started yet), only the following commands will be accepted: **GetCD**, **GetSD**, **GetCC**, **GetEC**, **ResetEC**, **GetHD**, **DS**, **DCal**, **TS**, **SL**, **SLT**, **GetLastSamples:x**, **QS**, and **Stop**

Example: Autonomous Sampling (user input in bold)

Wake up 16plus V2. Set date and time to September 1, 2012 at 9:05 am. Initialize logging to overwrite previous data in memory. Set up with 1 voltage sensor, take a sample every 120 sec, take and average 4 measurements for each sample, do not transmit real-time data, and output data in raw hex format. Set up pump to run for 0.5 sec before each sample. Set up to start logging on September 15, 2012 at 11 am. Send command to start logging at designated date and time. After all parameters are entered, verify setup. Send power-off command.

(Click Connect in Seaterm232's Communications menu to connect and wake up.)

```
DATETIME=09012012090500
INITLOGGING
VOLT0=Y
SAMPLEINTERVAL=120
NCYCLES=4
TXREALTIME=N
OUTPUTFORMAT=0
PUMPMODE=1
STARTDATETIME=09152012110000
STARTLATER
GETCD      (to verify setup)
QS
```

Deploy 16plus V2. Logging starts automatically at designated date and time.

Upon recovering 16plus V2, stop logging. Upload data in memory, in format SBE Data Processing can use. Send power-off command.

(Click Connect in Seaterm232's Communications menu to connect and wake up.)

```
STOP
(Click Upload– Seaterm232 leads you through screens to define data to be uploaded and where to store it.)
QS
```

Serial Line Synchronization (Serial Line Sync)

Serial Line Sync allows a simple pulse on the RS-232 line to initiate a sample. This mode provides easy integration with ADCPs or current meters, which can synchronize SBE 16plus V2 sampling with their own without drawing on their battery or memory resources.

If this mode is enabled (**SyncMode=Y**) and the SBE 16plus V2 is powered down, setting the RS-232 RX line high (3 –10 VDC) for 1 to 1000 millisecond wakes up the 16plus V2 and executes a Take Sample command:

- Take sample
- Store sample in FLASH memory
- Output real-time data (if **TxRealTime=Y**)

After executing the Take Sample command, the SBE 16plus V2 checks the RS-232 line and **SyncWait**. These determine whether to power down immediately or accept commands from the computer, and whether to leave the serial line sync mode enabled or disable it:

- **SyncWait=0** and **Mark State** (RS-232 RX line less than 0.5 volts)
16plus V2 immediately powers down. Serial line sync mode remains enabled (**SyncMode=Y**).
- **SyncWait=0** and **Space State** (RS-232 RX line greater than 3 volts)
16plus V2 monitors the RS-232 line for a time equivalent to 25 characters (actual length of time is dependent on the baud rate):
 - Line remains in space state - 16plus V2 disables serial line sync mode (sets **SyncMode=N**) at end of time. Once serial line sync mode is disabled, you can communicate with the 16plus V2 using the full range of commands (operating commands, logging commands, uploading command, etc.).
 - Line returns to mark state - 16plus V2 immediately powers down. Serial line sync mode remains enabled (**SyncMode=Y**).
- **SyncWait>0**
16plus V2 monitors the RS-232 line for **SyncWait** sec. Each time a carriage return (Enter key) is detected, the time-out clock is reset to 2 minutes. Within that time period, you can communicate with the 16plus V2 using the full range of commands (operating commands, logging commands, uploading command, etc.). While the 16plus V2 is monitoring:
 - More than 25 break characters are received - 16plus V2 disables serial line sync mode (sets **SyncMode=N**). Once serial line sync mode is disabled, you can communicate with the 16plus V2 using the full range of commands (operating commands, logging commands, uploading command, etc.).
 - Less than 25 break characters are received - 16plus V2 powers down when the time-out clock runs down. Serial line sync mode remains enabled (**SyncMode=Y**).

In summary, to disable serial line sync mode after executing the take sample command:

- **SyncWait = 0**
Put RS-232 line in space state (greater than 3 volts) for time equivalent to 25 characters.
- **SyncWait > 0**
 - Send 25 break characters, or
 - If **SyncWait** is greater than 5 sec, send **SyncMode=N** after waiting at least 3 sec after executing the take sample command.

Note:

If running Seaterm232, select *Send 5 second break* in the Command menu to hold the RS-232 RX line in space state for 5 sec. This will always be more than 25 break characters, and will cause the 16plus V2 to exit Serial Line Sync mode.

*Example: **Serial Line Sync*** (user input in bold)

Wake up 16plus V2. Set current date and time to November 1, 2012 at 9:05 am. Initialize logging to overwrite previous data in memory. Set up with 1 voltage sensor, take and average 4 measurements for each sample, output data in converted decimal format. Set **SyncWait** to 25 sec and enable serial line sync mode. After all parameters are entered, verify setup. Send power off command.

(Click Connect in Seaterm232's Communications menu to connect and wake up.)

DATE TIME=11012012090500

INIT LOGGING

VOLT0=Y

NCYCLES=4

TXREALTIME=Y

OUTPUTFORMAT=3

SYNCWAIT=25

SYNCMODE=Y

GETCD (to verify setup)

QS

Take samples using serial line sync mode:

(Set RS-232 RX line high [3-10 VDC] for 1-1000 millisecond. 16plus V2 takes sample, stores data in memory, and outputs data. Do not send any characters – 16plus V2 powers down after 25 sec.)

(Repeat this process at periodic intervals as desired.)

When ready to upload all data to computer, disable serial line sync mode, and then upload data and power down:

(Set RS-232 RX line high [3-10 VDC] for 1-1000 millisecond. 16plus V2 takes sample, stores data in memory, and outputs data.)

(Within 25 sec [**SyncWait** timeout], select *Send 5 second break* in Command menu to disable serial line sync mode.)

(Press Enter key)

GETSD (to verify 16plus V2 is communicating)

(Click Upload – Seaterm232 leads you through screens to define data to be uploaded and where to store it.)

QS

Pump Operation

Do not run the pump dry. The pump is water lubricated; running it without water will damage it. If briefly testing your system in dry conditions, fill the inside of the pump head with water via the pump exhaust port. This will provide enough lubrication to prevent pump damage during brief testing.

Pump operation is governed by three user-programmable parameters:

- PumpMode=0, 1, or 2**
 16plus V2 can be set up to operate with no pump (0), with the pump running for 0.5 sec before each sample (1), or with the pump running during each sample (2).
- DelayBeforeSampling=**
 16plus V2 can be set up to delay sampling after turning on power to external voltage and RS-232 sensors. Some sensors require time to equilibrate or stabilize after power is applied, to provide good quality data. WET Labs sensors with bio-wipers require time to open the bio-wiper before sampling.
- DelayAfterSampling=**
 16plus V2 can be set up to delay turning off power to the pump and external voltage and RS-232 sensors. WET Labs sensors with bio-wipers require time to shut the bio-wiper after sampling is completed.

These parameters interact in the operation of the pump, as shown below. Recommendations for settings are provided on the next page.

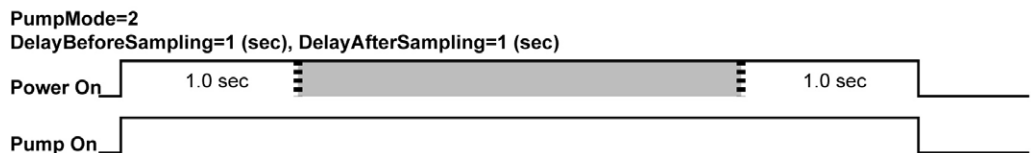
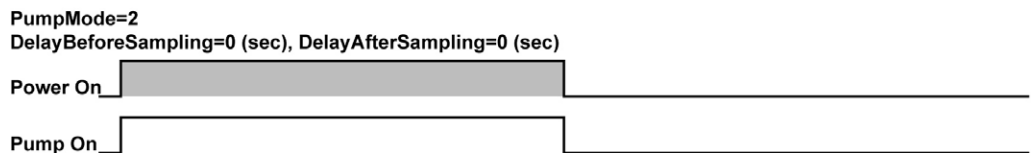
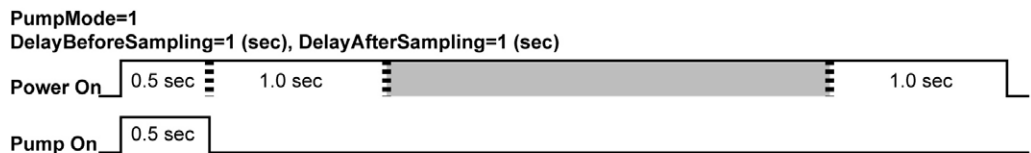
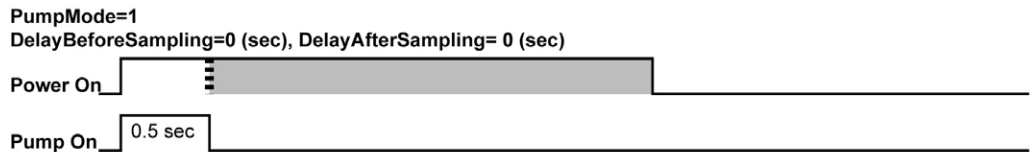

█ = sampling time (≥ 2.2 seconds)

Note: Sampling time includes time for instrument to warm up as well as time to measure parameters. The 2.2 sec sampling time is for 16plus V2 with no internally mounted pressure sensor, and 1 measurement/sample (NCycles=1). See Specifications in Section 2: Description of SBE 16plus V2 for sampling times for other setups.

Pump Setting Recommendations

Note:

DelayAfterSampling= is typically set to a non-zero value only if using a WET Labs sensor with a bio-wiper.

Sea-Bird provides the following recommendations for pump settings. Note that longer pump times increase power usage, reducing battery endurance. See *Battery Endurance* in *Section 2: Description of SBE 16plus V2* for sample battery endurance calculations.

Pump through Conductivity Cell Only (SBE 5M, 5P, or 5T pump)

For most deployments, set **PumpMode=1** and **DelayBeforeSampling=0**. The pump operates for 0.5 sec before the conductivity measurement is made, providing enough time to ventilate the cell and bring in a new sample of water.

If the 16plus V2 is moored in an area with large thermal gradients, it may be necessary to pump for a longer period of time, to eliminate any cell thermal mass effects on the measurement. In this case, set **PumpMode=2** and set **DelayBeforeSampling=** to a non-zero value, providing additional ventilation time (allowing the conductivity cell temperature to equilibrate to the water temperature) before taking the measurement.

Pump through Conductivity Cell and SBE 43 Dissolved Oxygen Sensor (requires SBE 5P or 5T pump)

Set **PumpMode=2**.

As the pump brings new water into the SBE 43 plenum, time is required for the sensor to equilibrate to the new oxygen level. The time required is dependent on the sensor's membrane thickness, and on the water temperature. Prior to 2007, all SBE 43s were sold with a 0.5 mil thick membrane. Sea-Bird now offers two membrane thicknesses:

- **0.5 mil thick** (faster response, typically for profiling applications) – Recommended **DelayBeforeSampling=** varies in a non-linear fashion, from 15 sec at 15 °C to 30 sec at 0 °C.
- **1.0 mil thick** (slower response but more durable, typically for moored applications) – Recommended **DelayBeforeSampling=** varies in a non-linear fashion, from 25 sec at 15 °C to 40 sec at 0 °C.

Note:

See *Application Note 64: SBE 43 Dissolved Oxygen Sensor – Background Information, Deployment Recommendations, and Cleaning and Storage* for the response time curves.

Pump through Conductivity Cell and SBE 63 Optical Dissolved Oxygen Sensor (requires SBE 5P or 5T pump)

Set **PumpMode=2**.

As the pump brings new water into the SBE 63 plenum, time is required for the sensor to equilibrate to the new oxygen level. The time required is dependent on the water temperature. Recommended **DelayBeforeSampling=** varies in a linear fashion, from 25 sec at 15 °C to 40 sec at 0 °C.

Note:

See the *SBE 63 manual*.

Pump through Conductivity Cell and Beckman- or YSI-type Dissolved Oxygen Sensor (requires SBE 5P or 5T pump)

Set **PumpMode=2**.

Set **DelayBeforeSampling=** to 120 to 180 sec, allowing time for the oxygen sensor to polarize before taking the measurement.

Real-Time Setup

Notes:

- Set baud rate with **BaudRate=**.
- Set data storage rate and real-time output rate with **SampleInterval=**.
- Include auxiliary A/D sensors in the data stream with **VoltN=** commands. Include auxiliary RS-232 sensors in the data stream with **SBE38=**, **SBE50=**, **GTD=**, or **DualGTD=** commands.
- Set output format with **OutputFormat=**.
- Set **TxRealTime=Y** to output real-time data.
- If using external power, see *External Power* in *Section 2: Description of SBE 16plus V2* for power limitations on cable length.
- Check the capability of your computer and terminal program before increasing the baud rate; high baud rates require a short cable and good PC serial port with accurate clock.

Baud Rate and Cable Length

The rate that real-time data can be transmitted from the SBE 16plus V2 is dependent on the amount of data to be transmitted per scan and the serial data baud rate:

$$\text{Time required to transmit data} = \frac{\text{(number of characters * 10 bits/character)}}{\text{baud rate}}$$

where

Number of characters is dependent on the included data and output format (see *Data Output Formats*).

Add 2 to the number of characters shown in the output format, to account for the carriage return and line feed at the end of each scan.

For decimal output (**OutputFormat=2, 3, or 5**), include decimal points, commas, and spaces when counting the number of characters.

Time required to transmit data plus the time required to make the measurements must be less than the (interval between samples – 5 sec) for Autonomous Sampling, because the 16plus V2 goes to sleep for a minimum of 5 sec between each sample.

The length of cable that the SBE 16plus V2 can drive is also dependent on the baud rate. The allowable combinations are:

Maximum Cable Length (meters)	Maximum Baud Rate
1600	600
800	1200
400	2400
200	4800
100	9600
50	19200
25	38400
16	57600
8	115200

Example 1 - 16plus V2 with optional internally mounted strain gauge pressure sensor, configured with 4 external voltages and 10 measurements/sample (**NCycles=10**). What is the smallest sample interval you can use if you want to transmit real-time data over 800 m with **OutputFormat=0** (raw hexadecimal data)?

With 800 meters of cable, the 16plus V2 requires a baud rate of 1200 or less.

Number of characters for **OutputFormat=0** (from *Data Output Formats*) =

6 (T) + 6 (C) + 6 (P) + 4 (P temperature compensation) + 4*4 (external voltages) + 8 (time) + 2 (carriage return & line feed) = 48

Time required to transmit data = (48 characters * 10 bits/character) / 1200 = 0.4 sec

Minimum time required for each sample =

(2.2 + 0.3) sec sampling time + [(10-1) * 0.25 sec] + 0.4 sec to transmit real-time + 5 sec sleep between samples
= 10.15 sec > minimum allowable sample interval of 10 sec

Therefore, set **SampleInterval=12** (round up to account for any small differences in sample timing), storing and transmitting one sample every 12 sec for this configuration.

Example 2 – Same as above, but you have set **DelayBeforeSampling=15**.

Minimum time required for each sample = 10.15 sec + 15 sec (delay after turning on power) = 25.15 sec, round up to 27
Therefore, set **SampleInterval=27**, storing and transmitting one sample every 27 sec.

Real-Time Data Acquisition

Real-time data can be acquired in either of the following ways:

- With Seasave (**typical method**) – When the 16plus V2 is set up for autonomous sampling, data can be viewed in Seasave in tabular form or as plots, as raw data or as converted (engineering units) data. Data acquired with Seasave can be processed with SBE Data Processing. See Seasave's Help files for details on setting up the program displays, baud rates, etc., and beginning data acquisition.
- With Seaterm232 – Click the Capture menu; enter the desired file name in the dialog box, and click Save. Begin sampling. The data displayed in Seaterm232 will be saved to the designated file. Process the data as desired. Note that this file **cannot be processed by Seasave or SBE Data Processing, as it does not have the required headers and format for Sea-Bird's processing software.**

Note:

If the FLASH memory is filled to capacity, data sampling and transmission of real-time data (if programmed) continue, but excess data is not saved in memory.

Timeout Description

The SBE 16plus V2 has a timeout algorithm. If the 16plus V2 does not receive a command or sample data for 2 minutes, it powers down its main digital circuits. This places the 16plus V2 in quiescent state, drawing minimal current.

To re-establish control (wake up), click Connect in Seaterm232's Communications menu or press the Enter key.

Command Descriptions

This section describes commands and provides sample outputs.
See *Appendix III: Command Summary* for a summarized command list.

When entering commands:

- Input commands to the 16plus V2 in upper or lower case letters and register commands by pressing the Enter key.
- The 16plus V2 sends an error message if an invalid command is entered.
- (if **OutputExecutedTag=N**) If the 16plus V2 does not return an S> prompt after executing a command, press the Enter key to get the S> prompt.
- If a new command is not received within 2 minutes after the completion of a command, the 16plus V2 returns to the quiescent (sleep) state.
- If in quiescent state, re-establish communications by clicking *Connect* in Seaterm232's Communications menu or pressing the Enter key.
- If the 16plus V2 is transmitting data and you want to stop it, press the Esc key or type ^C. Then press the Enter key. Alternatively, select *Abort* in Seaterm232's Command menu.
- Commands to enable a parameter or output (such as enabling a voltage channel) can be entered with the *argument* as Y or 1 for yes, and N or 0 for no (for example, **Volt0=y** and **Volt0=1** are equivalent; both enable voltage channel 0).
- The 16plus V2 cannot have samples with different scan lengths (more or fewer data fields per sample) in memory. If the scan length is changed by commanding it to add or subtract a data field (such as an external voltage), the 16plus V2 must initialize logging. Initializing logging sets the sample number and header number to 0, so the entire memory is available for recording data with the new scan length. **Initializing logging should only be performed after all previous data has been uploaded.** Therefore, commands that change the scan length (**PType=**, **Volt0=**, **Volt1=**, **Volt2=**, **Volt3=**, **Volt4=**, **Volt5=**, **SBE63=**, **SBE38=**, **SBE50=**, **WetLabs=**, **GTD=**, **DualGTD=**, **Optode=**) prompt the user for verification before executing, to prevent accidental overwriting of existing data.
- The 16plus V2 responds only to **GetCD**, **GetSD**, **GetCC**, **GetEC**, **ResetEC**, **GetHD**, **DS**, **DCal**, **TS**, **SL**, **SLT**, **GetLastSamples:x**, **QS**, and **Stop** while sampling autonomously. If you wake the 16plus V2 while it is sampling autonomously (for example, to send **DS** to check on progress), it temporarily stops sampling. Autonomous sampling resumes when it goes back to sleep (either by sending **QS** or after the 2-minute timeout).
- The 16plus V2 responds only to **GetCD**, **GetSD**, **GetCC**, **GetEC**, **ResetEC**, **GetHD**, **DS**, **DCal**, **TS**, **SL**, **SLT**, **GetLastSamples:x**, **QS**, and **Stop** while *waiting to start autonomous sampling* (if you sent **StartLater** but sampling has not started yet). To send any other commands, send **Stop**, send the desired commands to modify the setup, and then send **StartLater** again.

Entries made with the commands are permanently stored in the SBE 16plus V2 and remain in effect until you change them.

- The only exception occurs if the electronics are removed from the housing and disconnected from the battery Molex connector (see *Appendix II: Electronics Disassembly/Reassembly*). Upon reassembly, reset the date and time (**DateTime=**) and initialize logging (**InitLogging**).

Status Command

Notes:

- **GetCD** output does not include calibration coefficients. To display calibration coefficients, use the **GetCC** command.
- The **DS** response contains similar information as the combined responses from **GetSD** and **GetCD**, but in a different format.

GetCD

Get and display configuration data, which includes all parameters related to setup of 16*plus* V2, including communication settings and sampling settings. Most of these parameters can be user-input/modified. List below includes, where applicable, command used to modify parameter:

- Device type, Serial number
- Sample interval [**SampleInterval=**]
- Number of measurements to take and average per sample [**NCycles=**]
- Integration time for Quartz pressure sensor [**ParosIntegration=**] (only appears if **PType=3**)
- Reference pressure to use if no internally mounted pressure sensor [**RefPress=**] (only appears if **PType=0**)
- Pump turn-on parameter [**PumpMode=**]
- Turn-on delay [**DelayBeforeSampling=**]
- Turn-off delay [**DelayAfterSampling=**]
- Transmit data real-time [**TxRealTime=**]?
- Battery cut-off voltage
- Sample external voltages 0, 1, 2, 3, 4, and 5 [**Volt0=** through **Volt5=**]?
- Sample SBE 38 secondary temperature sensor [**SBE38=**]?
- Sample SBE 50 secondary pressure sensor? [**SBE50=**]?
- Sample WET Labs RS-232 sensor [**WetLabs=**]?
- Sample Optode [**Optode=**]?
- Sample SBE 63 optical dissolved oxygen sensor [**SBE63=**]?
- Sample Gas Tension Device [**GTD=**], or dual Gas Tension Devices [**DualGTD=**]?
- Enable echoing [**Echo=**]?
- Output Executing and Executed tags [**OutputExecutedTag=**]?
- Output format [**OutputFormat=**]
- Output salinity [**OutputSal=**]?
(only appears if output format = converted decimal or converted XML UVIC)
- Output sound velocity [**OutputSV=**]?
(only appears if output format = converted decimal or converted XML UVIC)
- Output sigma-t, voltage, and current with each sample [**OutputUCSD=**]?
(only appears if output format = converted decimal or converted XML UVIC)
- Serial line sync mode [**SyncMode=**]?

Status Commands (continued)

Example: Send GetCD to 16plus V2 with strain gauge pressure sensor (user input in bold, command used to modify parameter in parentheses)

getcd

```

<ConfigurationData DeviceType='SBE16plus' SerialNumber='01606001'>
  <SamplingParameters>
    <SampleInterval>15</SampleInterval>
    <MeasurementsPerSample>1</MeasurementsPerSample>
    <Pump>run pump during sample</Pump>
    <DelayBeforeSampling>0.0</DelayBeforeSampling>
    <DelayAfterSampling>0.0</DelayAfterSampling>
    <TransmitRealTime>no</TransmitRealTime>
  </SamplingParameters>
</Battery>
  <CutOff>7.5</CutOff>
</Battery>
  <DataChannels>
    <ExtVolt0>yes</ExtVolt0>
    <ExtVolt1>no</ExtVolt1>
    <ExtVolt2>no</ExtVolt2>
    <ExtVolt3>yes</ExtVolt3>
    <ExtVolt4>no</ExtVolt4>
    <ExtVolt5>no</ExtVolt5>
    <SBE38>no</SBE38>
    <SBE50>no</SBE50>
    <WETLABS>no</WETLABS>
    <OPTODE>no</OPTODE>
    <SBE63>no</SBE63>
    <GTD>no</GTD>
  </DataChannels>
  <EchoCharacters>yes</EchoCharacters>
  <OutputExecutedTag>no</OutputExecutedTag>
  <OutputFormat>converted decimal</OutputFormat>
  <OutputSalinity>no</OutputSalinity>
  <OutputSoundVelocity>no</OutputSoundVelocity>
  <OutputSigmaT-V>no</OutputSigmaT-V>
  <SerialLineSync>no</SerialLineSync>
</ConfigurationData>

```

[SampleInterval=]
[NCycles=]
[PumpMode=]
[DelayBeforeSampling=]
[DelayAfterSampling=]
[TxRealTime=]
[Volt0=]
[Volt1=]
[Volt2=]
[Volt3=]
[Volt4=]
[Volt5=]
[SBE38=]
[SBE50=]
[WetLabs=]
[Optode=]
[SBE63=]
[GTD= or DualGTD=]
[Echo=]
[OutputExecutedTag=]
[OutputFormat=]
[OutputSal=]
[OutputSV=]
[OutputUCSD=]
[SyncMode=]

Status Commands (continued)**Notes:**

- The **DS** response contains similar information as the combined responses from **GetSD** and **GetCD**, but in a different format.
- If configured with a pump, sending **GetSD** causes the pump to turn on for a moment, so that the 16plus V2 can measure and output the pump current. Because the pump is designed to be water lubricated, you will hear a noise when the impeller spins in air. Running the pump *dry* for such a **short** time will not harm the pump.
- In the example below, only voltage channel 0 is enabled, so external voltage current iext2345= (for channels 2, 3, 4, and 5) is not shown.
- In the example below, no RS-232 sensor is enabled, so RS-232 sensor current iserial= is not shown.
- If the 16plus V2 is set up with a WET Labs sensor with Bio-Wiper (**Biowiper=Y**) and if **OutputExecutedTag=Y**, the **GetSD** response shows: <Executing/> to allow time for the Bio-Wiper to close before it measures the enabled external voltage currents.

GetSD

Get and display status data, which contains data that changes while deployed. List below includes, where applicable, command used to modify parameter:

- Device type, Serial number
- Date and time [**DateTime=**] in ISO8601-2000 extended format (yyyy – mm-ddThh:mm:ss)
- Logging status (not logging, logging, waiting to start at . . ., or unknown status)
- Number of recorded events in event counter [reset with **ResetEC**]
- Voltages and currents -
 - Main battery voltage
 - Back-up lithium battery voltage
 - Operating current
 - Pump current
 - External voltage sensor current (channels 0 and 1) – displays only if 1 or more channels enabled
 - External voltage sensor current (channels 2, 3, 4, and 5) – displays only if 1 or more channels enabled
 - RS-232 sensor current – displays only if channel enabled
- Memory - [reset with **InitLogging**]
 - Number of bytes in memory
 - Number of samples in memory
 - Number of additional samples that can be placed in memory
 - Length (number of bytes) of each sample
 - Number of headers in memory

Example: (user input in bold, command used to modify parameter in parentheses)

getsd

```

<StatusData DeviceType = 'SBE16plus' SerialNumber = '01606001'>
  <DateTime>2012-01-24T10:53:03</DateTime>                                [DateTime=]
  <LoggingState>not logging</LoggingState>
  <EventSummary numEvents = '0' />                                     [can clear with ResetEC]
  <Power>
    <vMain>10.1</vMain>
    <vLith>8.9</vLith>
    <iMain>61.9</iMain>
    <iPump>20.6</iPump>
    <iExt01>67.2</iExt01>
  </Power>
  <MemorySummary>
    <Bytes>0</Bytes>                                                    [can clear with InitLogging]
    <Samples>0</Samples>                                              [can clear with InitLogging]
    <SamplesFree>3463060</SamplesFree>
    <SampleLength>19</SampleLength>
    <Headers>0</Headers>                                             [can clear with InitLogging]
  </MemorySummary>
</StatusData>

```

Notes:

- **DCal** and **GetCC** responses contain similar information, but in different formats.
- Dates shown are when calibrations were performed.

Status Commands (*continued*)**GetCC**

Get and display calibration coefficients, which are initially factory-set and should agree with Calibration Certificates shipped with 16plus V2.

Example: 16plus V2 with internally mounted strain gauge pressure sensor (user input in bold, command used to modify coefficient in parentheses)

getcc

```

<CalibrationCoefficients DeviceType = 'SBE16plus' SerialNumber = '01606001'>
  <Calibration format = 'TEMP1' id = 'Main Temperature'>
    <SerialNum>01606001</SerialNum>
    <CalDate>19-Mar-11</CalDate>
    <TA0>1.155787e-03</TA0>
    <TA1>2.725208e-04</TA1>
    <TA2>-7.526811e-07</TA2>
    <TA3>1.716270e-07</TA3>
    <TOFFSET>0.000000e+00</TOFFSET>
  </Calibration>
  <Calibration format = 'WBCOND0' id = 'Main Conductivity'>
    <SerialNum>01606001</SerialNum>
    <CalDate>19-Mar-11</CalDate>
    <G>-1.006192e+00</G>
    <H>1.310565e-01</H>
    <I>-2.437852e-04</I>
    <J>3.490353e-05</J>
    <CPCOR>-9.570000e-08</CPCOR>
    <CTCOR>3.250000e-06</CTCOR>
    <CSLOPE>1.000000e+00</CSLOPE>
  </Calibration>
  <Calibration format = 'STRAIN0' id = 'Main Pressure'>
    <SerialNum>01600003</SerialNum>
    <CalDate>27-Mar-11</CalDate>
    <PA0>-5.137085e-02</PA0>
    <PA1>1.550601e-03</PA1>
    <PA2>7.210415e-12</PA2>
    <PTCA0>5.154159e+05</PTCA0>
    <PTCA1>2.560262e-01</PTCA1>
    <PTCA2>-8.533080e-02</PTCA2>
    <PTCB0>2.426612e+01</PTCB0>
    <PTCB1>-7.750000e-04</PTCB1>
    <PTCB2>0.000000e+00</PTCB2>
    <PTEMPA0>-7.667877e+01</PTEMPA0>
    <PTEMPA1>4.880376e+01</PTEMPA1>
    <PTEMPA2>-4.555938e-01</PTEMPA2>
    <POFFSET>0.000000e+00</POFFSET>
    <PRANGE>1.000000e+03</PRANGE>
  </Calibration>
  <Calibration format = 'VOLT0' id = 'Volt 0'>
    <OFFSET>0.000000e+00</OFFSET>
    <SLOPE>1.260977e+00</SLOPE>
  </Calibration>
  <Calibration format = 'VOLT0' id = 'Volt 1'>
    <OFFSET>-4.728750e-02</OFFSET>
    <SLOPE>1.259474e+00</SLOPE>
  </Calibration>
  <Calibration format = 'VOLT0' id = 'Volt 2'>
    <OFFSET>-4.715313e-02</OFFSET>
    <SLOPE>1.259946e+00</SLOPE>
  </Calibration>
  <Calibration format = 'VOLT0' id = 'Volt 3'>
    <OFFSET>-4.772396e-02</OFFSET>
    <SLOPE>1.260486e+00</SLOPE>
  </Calibration>
  <Calibration format = 'VOLT0' id = 'Volt 4'>
    <OFFSET>-4.765417e-02</OFFSET>
    <SLOPE>1.260014e+00</SLOPE>
  </Calibration>
  <Calibration format = 'VOLT0' id = 'Volt 5'>
    <OFFSET>-4.744167e-02</OFFSET>
    <SLOPE>1.260255e+00</SLOPE>
  </Calibration>
  <Calibration format = 'FREQ0' id = 'external frequency channel'>
    <EXTFREQSF>1.000000e+00</EXTFREQSF>
  </Calibration>
</CalibrationCoefficients>

```

[TCalDate=]
[TA0=]
[TA1=]
[TA2=]
[TA3=]
[TOffset=]

[CCalDate=]
[CG=]
[CH=]
[CI=]
[CJ=]
[CPCor=]
[CTCor=]
[CSlope=]

[PCalDate=]
[PA0=]
[PA1=]
[PA2=]
[PTCA0=]
[PTCA1=]
[PTCA2=]
[PTCB0=]
[PTCB1=]
[PTCB2=]
[PTempA0=]
[PTempA1=]
[PTempA2=]
[POffset= (decibars)]
[PRange= (psia); factory set]

[factory set]
[factory set]

[factory set]
[factory set]

[factory set]
[factory set]

[factory set]
[factory set]

[factory set]
[factory set]

[factory set]
[factory set]

[factory set]

Status Commands (*continued*)**GetEC**

Get and display event counter data, which can help to identify root cause of a malfunction. Event counter records number of occurrences of common timeouts, power-on resets, etc. Can be cleared with **ResetEC**. Possible events that may be logged include:

- Power fail – main batteries and/or external voltage below voltage cutoff
- EEPROM read or EEPROM write – all power removed (main batteries removed, and back-up lithium batteries are dead)
- Alarm short – woke up 16plus V2 to send a command while logging
- Alarm long – sent **StartLater**, but **StartDateTime** is more than 1 month in future
- AD7730 timeout – response from temperature and pressure A/D converter delayed; typically if woke up to send a command while logging
- AD7714 timeout – response from voltage channel A/D converter delayed; typically if woke up to send a command while logging
- FLASH out of memory – all available memory space is used; autonomous sampling continues, but no additional data written to FLASH (does not overwrite)
- FLASH correctable error – single bit error in a page, corrects itself, does not affect data
- FLASH ECC error – does not affect data
- FLASH timeout – problem with FLASH
- FLASH ready – problem with FLASH; timeout error
- FLASH erase failed – problem with FLASH
- FLASH write failed – problem with FLASH
- FLASH uncorrectable – problem with FLASH; 2 or more bits of errors in a page
- FLASH block overrun – problem with FLASH
- New bad block – problem with FLASH; FLASH write or erase failed, or a FLASH uncorrectable error

Example (user input in bold, command used to modify parameter in parentheses)

getec

```
<EventCounters DeviceType = 'SBE16plus' SerialNumber = '01606001'>
  <EventSummary numEvents = '1' />
  <Event type='alarm short' count='1' />
</EventCounters>
```

[can clear with **ResetEC**]

ResetEC

Delete all events in event counter (number of events displays in **GetSD** response, and event details display in **GetEC** response).

Status Commands (continued)**GetHD**

Get and display hardware data, which is fixed data describing 16plus V2:

- Device type, Serial number
- Manufacturer
- Firmware version
- Firmware date
- Command set version
- PCB serial number and assembly number
- Manufacture date
- Internal sensor types and serial numbers
- External voltage sensor types (DO, fluorometer, etc.) and serial numbers
- External RS-232 sensor types (SBE 63, SBE 38, WET Labs, etc.) and serial numbers

Note:

External sensor types and serial numbers can be changed in the field, to accommodate changes in auxiliary sensors cabled to the 16plus V2. Other hardware data is typically not changed by the user.

Example: (user input in bold, command used to modify parameter in parentheses)

gethd

```

<HardwareData DeviceType = 'SBE16plus' SerialNumber = '01606001'>
  <Manufacturer>Sea-Bird Electronics, Inc.</Manufacturer>
  <FirmwareVersion>2.5</FirmwareVersion>
  <FirmwareDate>26 Apr 2012 16:37</FirmwareDate>
  <CommandSetVersion>2.3</CommandSetVersion>
  <PCBAssembly PCBSerialNum = '20570' AssemblyNum = '41054G' />
  <PCBAssembly PCBSerialNum = '22203' AssemblyNum = '41580B' />
  <PCBAssembly PCBSerialNum = '20120' AssemblyNum = '41606' />
  <PCBAssembly PCBSerialNum = '21054' AssemblyNum = '41059D' />
  <MfgDate>12 Jan 2012</MfgDate>
  <InternalSensors>
    <Sensor id = 'Main Temperature'>
      <type>temperature0</type>
      <SerialNumber>01606001</SerialNumber>
    </Sensor>
    <Sensor id = 'Main Conductivity'>
      <type>conductivity-0</type>
      <SerialNumber>01606001</SerialNumber>
    </Sensor>
    <Sensor id = 'Main Pressure'>
      <type>strain-0</type>
      <SerialNumber>2580011</SerialNumber>
    </Sensor>
  </InternalSensors>
  <ExternalSensors>
    <Sensor id = 'volt 0'>
      <type>not assigned</type>
      <SerialNumber>not assigned</SerialNumber>
    </Sensor>
    <Sensor id = 'volt 1'>
      <type>not assigned</type>
      <SerialNumber>not assigned</SerialNumber>
    </Sensor>
    <Sensor id = 'volt 2'>
      <type>not assigned</type>
      <SerialNumber>not assigned</SerialNumber>
    </Sensor>
    <Sensor id = 'volt 3'>
      <type>not assigned</type>
      <SerialNumber>not assigned</SerialNumber>
    </Sensor>
    <Sensor id = 'volt 4'>
      <type>not assigned</type>
      <SerialNumber>not assigned</SerialNumber>
    </Sensor>
    <Sensor id = 'volt 5'>
      <type>not assigned</type>
      <SerialNumber>not assigned</SerialNumber>
    <Sensor id = 'serial'>
      <type>not assigned</type>
      <SerialNumber> not assigned </SerialNumber>
    </Sensor>
  </ExternalSensors>
</HardwareData>

```

[SetVoltType0=]
[SetVoltSN0=]

[SetVoltType1=]
[SetVoltSN1=]

[SetVoltType2=]
[SetVoltSN2=]

[SetVoltType3=]
[SetVoltSN3=]

[SetVoltType4=]
[SetVoltSN4=]

[SetVoltType5=]
[SetVoltSN5=]

[SetSerialType=]
[SetSerialSN=]

Status Commands (continued)

Notes:

- The **DS** response contains similar information as the combined responses from **GetSD** and **GetCD**, but in a different format.
- If configured with a pump, sending **DS** causes the pump to turn on for a moment, so that the 16plus V2 can measure and output the pump current. Because the pump is designed to be water lubricated, you will hear a noise when the impeller spins in air. Running the pump *dry* for such a **short** time will not harm the pump.
- In the example below, only voltage channel 0 is enabled, so external voltage current `ixt2345=` (for channels 2, 3, 4, and 5) is not shown.
- In the example below, no RS-232 sensor is enabled, so RS-232 sensor current `iserial=` is not shown.
- If the 16plus V2 is set up for dual GTDs, the **DS** response shows:
Dual Gas Tension Device = Yes
- If the 16plus V2 is set up with a WET Labs sensor with Bio-Wiper (**Biowiper=Y**), the **DS** response shows:
wait
4 seconds for biowiper to
close before it measures the
enabled external voltage currents.

DS

Get and display operating status and setup. List below includes, where applicable, command used to modify parameter.

- Firmware version, serial number, date and time [**DateTime=**]
- Voltages and currents (main and back-up lithium battery voltages; currents – operating, pump, external voltage sensors, RS-232 sensor)
- Logging status (not logging, logging, waiting to start at . . ., or unknown status)
- Number of samples and available sample space in memory
- Sample interval [**SampleInterval=**] and number of measurements to take and average per sample [**NCycles=**]
- Integration time [**ParosIntegration=**] (only appears if pressure sensor = quartz with temp comp)
- Pump turn-on parameter [**PumpMode=**], turn-on delay [**DelayBeforeSampling=**], turn-off delay [**DelayAfterSampling=**]
- Transmit data real-time [**TxRealTime=**]?
- Battery cut-off voltage
- Internally mounted pressure sensor type [**PType=**] and range [**PRange=**]; factory set
- Sample RS-232 sensor – SBE 38 secondary temperature sensor [**SBE38=**], SBE 50 pressure sensor [**SBE50=**], WET Labs [**WetLabs=**], Optode [**Optode=**], SBE 63 optical dissolved oxygen sensor [**SBE63=**], Gas Tension Device or Dual Gas Tension Devices [**GTD=** or **DualGTD=**]?
- Sample external voltages 0, 1, 2, 3, 4, and 5? [**Volt0=** through **Volt5=**]
- Show entered commands as you type [**Echo=**]?
- Output format [**OutputFormat=**]
- Output salinity [**OutputSal=**] and sound velocity [**OutputSV=**]?
(only if output format = converted decimal or converted XML UVIC)
- Serial sync mode state [**SyncMode=**] and wait time [**SyncWait=**] (only if enabled)
- Output sigma-t, voltage, and current [**OutputUCSD=**]?
(only if output format = converted decimal or converted XML UVIC; and if set to Y)

Example: (user input in bold, command used to modify parameter in parentheses)

DS

```

SBE 16plus V 2.5 SERIAL NO. 6001 24 May 2012 14:11:48 [DateTime=]
vbatt = 10.3, vlith = 8.5, ioper = 62.5 ma, ipump = 21.6 ma,
iext01 = 76.2 ma,
status = not logging
samples = 0, free = 3463060
sample interval = 15 seconds, number of measurements per sample = 1 [SampleInterval=, NCycles=]
pump = run pump during sample, delay before sampling = 2.0 seconds,
delay after sampling = 0.0 seconds [PumpMode=, DelayBeforeSampling=, DelayAfterSampling=]
transmit real-time = yes [TxRealTime=]
battery cutoff = 7.5 volts
pressure sensor = strain gauge, range = 1000.0 [PType=, PRange=; both factory set]
SBE 38 = no, SBE 50 = yes, WETLABS = no, OPTODE = no, SBE63 = no, Gas Tension Device = no
[SBE38=, SBE50=, WetLabs=, Optode=, SBE63=, GTD=, DualGTD=]
Ext Volt 0 = yes, Ext Volt 1 = no [Volt0= and Volt1=]
Ext Volt 2 = no, Ext Volt 3 = no [Volt2= and Volt3=]
Ext Volt 4 = no, Ext Volt 5 = no [Volt4= and Volt5=]
echo characters = yes [Echo=]
output format = raw HEX [OutputFormat=]
serial sync mode disabled [SyncMode=]

```

Status Commands (*continued*)**Notes:**

- The **DCal** and **GetCC** responses contain the same information, but in different formats.
- Dates shown are when calibrations were performed.

DCal

Get and display calibration coefficients, which are initially factory-set and should agree with Calibration Certificates shipped with 16plus V2.

Example: 16plus V2 with internally mounted strain gauge pressure sensor (user input in bold, command used to modify coefficient in parentheses).

dcal

SeacatPlus V 2.5 SERIAL NO. 6001 12 May 2012 14:46:05

temperature: 20-mar-11

TA0 = -3.178124e-06

TA1 = 2.751603e-04

TA2 = -2.215606e-06

TA3 = 1.549719e-07

TOFFSET = 0.000000e+00

conductivity: 20-mar-11

G = -9.855242e-01

H = 1.458421e-01

I = -3.290801e-04

J = 4.784952e-05

CPCOR = -9.570000e-08

CTCOR = 3.250000e-06

CSLOPE = 1.000000e+00

pressure S/N 2580011, range = 1000 psia: 24-mar-11

PA0 = 0.000000e+00

PA1 = 0.000000e+00

PA2 = 0.000000e+00

PTEMPA0 = 0.000000e+00

PTEMPA1 = 0.000000e+00

PTEMPA2 = 0.000000e+00

PTCA0 = 0.000000e+00

PTCA1 = 0.000000e+00

PTCA2 = 0.000000e+00

PTCB0 = 0.000000e+00

PTCB1 = 0.000000e+00

PTCB2 = 0.000000e+00

POFFSET = 0.000000e+00

volt 0: offset = 0.000000e+00, slope = 1.000000e+00

volt 1: offset = 0.000000e+00, slope = 1.000000e+00

volt 2: offset = 0.000000e+00, slope = 1.000000e+00

volt 3: offset = 0.000000e+00, slope = 1.000000e+00

volt 4: offset = 0.000000e+00, slope = 1.000000e+00

volt 5: offset = 0.000000e+00, slope = 1.000000e+00

EXTFREQSF = 1.000000e+00

[DateTime=]

[TCalDate=]

[TA0=]

[TA1=]

[TA2=]

[TA3=]

[TOffset=]

[CCalDate=]

[CG=]

[CH=]

[CI=]

[CJ=]

[CPCor=]

[CTCor=]

[CSlope=]

[PRange= (psia), PCalDate=]

[PA0=]

[PA1=]

[PA2=]

[PTempA0=]

[PTempA1=]

[PTempA2=]

[PTCA0=]

[PTCA1=]

[PTCA2=]

[PTCB0=]

[PTCB1=]

[PTCB2=]

[POffset= (decibars)]

[factory set]

[factory set]

[factory set]

[factory set]

[factory set]

[factory set]

[factory set]

General Setup Commands

DateTime=mmddyyhhmmss Set real-time clock month, day, year, hour, minute, second.

Example: Set current date and time to 05 March 2012 12:05:00 (user input in bold).

datetime=03052012120500

Notes:

- The 16plus V2 baud (set with **BaudRate=**) must be the same as Seaterm232's baud (set in the Communications menu).
- An RS-232 sensor (SBE 63, SBE 38, SBE 50, WET Labs, GTD, or Optode) integrated with the 16plus V2 must use the same baud as the 16plus V2. See the RS-232 sensor's manual to set its baud.
- **BaudRate=** must be sent twice. After the first entry, the 16plus V2 changes to the new baud, and then waits for the command to be sent again at the new baud (In the Communications menu, select *Configure*. In the dialog box, select the new baud rate and click OK. Then retype the command.). This prevents you from accidentally changing to a baud that is not supported by your computer. If it does not receive the command again at the new baud, it reverts to the previous baud.

BaudRate=x

x= baud rate (600, 1200, 2400, 4800, 9600, 19200, 38400, 57600, or 115200). **Default 9600**. Check capability of your computer and terminal program before increasing baud rate; high baud rates require a short cable and good PC serial port with accurate clock. **Command must be sent twice to change rate.**

Echo=x

x=Y: Echo characters received from computer (**default**) - computer monitor will show entered commands as you type.

x=N: Do not echo characters.

OutputExecutedTag=x

x=Y: Display XML Executing and Executed tags (**default**). Executed tag displays at end of each command response; Executing tag displays one or more times if 16plus V2 response to command requires additional time.

x=N: Do not.

Example: Set 16plus V2 to output Executed and Executing tags (user input in bold).

outputexecutedtag=y
 <Executed/>**getcd**
 . . . (**GetCD** response)
 <Executed/>

(Note: <Executed/> tag at end of command response takes place of S> prompt.)

Notes:

- **TxRealTime=**, **PumpMode=**, **NCycles=**, **ParosIntegration=**, and **DelayBeforeSampling=** affect the time required to sample. If the time required to sample is too high, the 16plus V2 is unable to take the required number of measurements and do the calculations within **SampleInterval=**. See *Sample Timing* in Section 2: Description of SBE 16plus V2.
- Pump operation is affected by **PumpMode=**, **DelayBeforeSampling=**, and **DelayAfterSampling=**. See *Pump Operation*.

TxRealTime=x

Applies to both autonomous (logging) and serial line sync modes.

x=Y: Output real-time data.

x=N: Do not output real-time data.

PumpMode=x

x=0: No pump.

x=1: Run pump for 0.5 sec before each sample (typical for pumping through conductivity cell only, with no auxiliary sensors connected to plumbing).

x=2: Run pump during each sample (typical for pumping through conductivity cell and in-line auxiliary sensor).

Note:

TxRealTime=, **PumpMode=**, **NCycles=**, **ParosIntegration=**, and **DelayBeforeSampling=** affect the time required to sample. If the time required to sample is too high, the 16plus V2 is unable to take the required number of measurements and do the calculations within **SampleInterval=**. See *Sample Timing* in *Section 2: Description of SBE 16plus V2*.

Notes:

- The 16plus V2 requires verification when **InitLogging**, **SampleNumber=**, or **HeaderNumber=** are sent. The 16plus V2 responds: this command will change the scan length and/or initialize logging. Repeat the command to verify. Type the command again and press the Enter key to proceed. The 16plus V2 responds: Scan length has changed, initializing logging
- Do not initialize logging until all data has been uploaded.** These commands do not delete data; they reset the data pointer. **If you accidentally initialize logging before uploading**, recover data as follows:
 - Set **SampleNumber=a** and **HeaderNumber=b**, where **a** and **b** are your estimate of number of samples and headers in memory.
 - Upload data. If **a** is more than actual number of samples or **b** is more than actual number of headers in memory, data for non-existent samples/headers will be bad, random data. Review uploaded data file carefully and delete any bad data.
 - If desired, increase **a** and/or **b** and upload data again, to see if there is additional valid data in memory.

Note:

If a WET Labs sensor with Bio-Wiper is installed and **Biowiper=N**, sending **GetSD** or **DS** will open the Bio-Wiper, but not provide enough powered time to close it again. If you then deploy the instrument with the Bio-Wiper open and with a delayed start time, the sensor may become fouled because the Bio-Wiper will remain open until the first sample is completed.

Note:

The 16plus V2 automatically enters quiescent (sleep) state after 2 minutes without receiving a command, conserving battery energy if the user does not send **QS** to put the 16plus V2 to sleep.

General Setup Commands (*continued*)**NCycles=x**

x= number of measurements to take and average for each sample. Range 1 – 100; **default 1**. 16plus V2 takes and averages **NCycles=** measurements (each 0.25 sec apart). For autonomous sampling and serial line sync mode, averaged data is stored in FLASH memory and (if **TxRealTime=Y**) transmitted real-time.

InitLogging

Initialize logging - after all previous data has been uploaded, initialize logging before starting to sample again to make entire memory available for recording. **InitLogging** sets sample number (**SampleNumber=**) and header number (**HeaderNumber=**) to 0 (sampling will start with sample 1 and header 1). If not set to 0, data will be stored after last recorded sample. **Do not send InitLogging until all existing data has been uploaded.**

SampleNumber=x

x= sample number for last sample in memory. Typically only used to recover data if you accidentally initialize logging (using **InitLogging**) before uploading all existing data. **Do not send SampleNumber=0 until all existing data has been uploaded.**

HeaderNumber=x

x= header number for last header in memory. Typically only used to recover data if you accidentally initialize logging (using **InitLogging**) before uploading all existing data. 16plus V2 can have a maximum of 1000 stored headers. Note that 16plus V2 writes a new header each time autonomous sampling is started and after every 2000 samples are stored in memory.

Biowiper=x

x=Y: Configuration includes WET Labs sensor with Bio-Wiper (voltage or RS-232 auxiliary sensor). With this setup, 16plusV2 is powered longer for **GetSD** and **DS**, providing sufficient time for Bio-Wiper to open and then shut again if sensor is set up to take 1 measurement for each sample (see *Application Note 72*).

x=N (default): No WET Labs sensor with Bio-Wiper.

QS

Quit session and place 16plus V2 in quiescent (sleep) state. Main power turned off. Data logging and memory retention are not affected.

Pressure Sensor Setup Commands

Note:

The 16plus V2 configuration (.xmlcon or .con) file must match the **PType=** selection of internally mounted pressure sensor when viewing real-time data or processing uploaded data. View and edit the configuration file in Seasave or SBE Data Processing. **PType=** is factory-set to match the ordered configuration.

PType=x

Internally mounted pressure sensor type (**set at factory; do not modify**).

x=0: No internally mounted pressure sensor.

x=1: Strain gauge.

x=3: Quartz with temperature compensation.

RefPress=x

x= reference pressure (gauge) in decibars to use if 16plus V2 does not include an internally mounted pressure sensor. 16plus V2 uses reference pressure in conductivity, salinity, and sound velocity calculation. Value entered for **RefPress=** is displayed in **GetCD** and **DS** responses if 16plus V2 does not include internally mounted pressure sensor.

Entry ignored if 16plus V2 includes internally mounted pressure sensor.

If 16plus V2 interfaces with an SBE 50 pressure sensor, it does **not** use SBE 50 data in conductivity, salinity, and sound velocity calculation.

Notes:

- The 16plus V2 does the integration for the Quartz pressure sensor *after* **NCycles=** measurements have been taken.
- **TxRealTime=**, **PumpMode=**, **NCycles=**, **ParosIntegration=**, and **DelayBeforeSampling=**, and **DelayAfterSampling=** affect the time required to sample. If the time required to sample is too high, the 16plus V2 is unable to take the required number of measurements and do the calculations within **SampleInterval=**. See *Sample Timing* in *Section 2: Description of SBE 16plus V2*.

ParosIntegration=x

x= integration time for optional internally mounted Quartz pressure sensor (not applicable for strain gauge pressure sensor). Range 1 – 600 sec; **default 1 sec**. Increasing integration time increases resolution. See *Specifications* in *Section 2: Description of SBE 16plus V2* to determine resolution for Quartz pressure sensor.

Notes:

- The 16plus V2 requires verification when **Volt0 =** through **Volt5=** are sent. The 16plus V2 responds: this command will change the scan length and/or initialize logging. Repeat the command to verify. Type the command again and press the Enter key to proceed. The 16plus V2 responds: Scan length has changed, initializing logging
- The 16plus V2 configuration (.xmlcon or .con) file must match this selection of number of external voltages when viewing real-time data or processing uploaded data. View and edit the configuration file in Seasave or SBE Data Processing. These parameters are factory-set to match the ordered instrument configuration.
- External voltage numbers 0, 1, 2, 3, 4, and 5 correspond to wiring of sensors to a voltage channel on the 16plus V2 end cap (see *Dimensions and End Cap Connectors* in Section 2: *Description of SBE 16plus V2*). However, in the .xmlcon or .con file, voltage 0 is the first external voltage in the data stream, voltage 1 is the second, etc.

Notes:

- **TxRealTime=**, **PumpMode=**, **NCycles=**, **ParosIntegration=**, **DelayBeforeSampling=**, and **DelayAfterSampling=** affect the time required to sample. If the time required to sample is too high, the 16plus V2 is unable to take the required number of measurements and do the calculations within **SampleInterval=**. See *Sample Timing* in Section 2: *Description of SBE 16plus V2*.
- Pump operation is affected by **DelayBeforeSampling=**, **DelayAfterSampling=**, and **PumpMode=**. See *Pump Operation*.
- **DelayBeforeSampling=** does not apply to the RS-232 Aanderaa Optode, because turning on power to the Optode causes it to sample. The 16plus V2 turns on power to the Optode when the 16plus V2 is ready to acquire Optode data.

Voltage Sensor Setup Commands

Volt0=x	x=Y: Enable external voltage 0. x=N: Do not enable external voltage 0.
Volt1=x	x=Y: Enable external voltage 1. x=N: Do not enable external voltage 1.
Volt2=x	x=Y: Enable external voltage 2. x=N: Do not enable external voltage 2.
Volt3=x	x=Y: Enable external voltage 3. x=N: Do not enable external voltage 3.
Volt4=x	x=Y: Enable external voltage 4. x=N: Do not enable external voltage 4.
Volt5=x	x=Y: Enable external voltage 5. x=N: Do not enable external voltage 5.

Example: Enable voltage sensors wired to channels 0 and 3 on end cap (user input in bold).

```
VOLT0=Y
VOLT1=N
VOLT2=N
VOLT3=Y
VOLT4=N
VOLT5=N
```

There will be 2 external sensor voltages in data stream. In .xmlcon or .con file (in SBE Data Processing or Seasave), select 2 external voltage channels. Voltage 0 corresponds to sensor wired to external voltage channel 0; voltage 1 corresponds to sensor wired to external voltage channel 3.

DelayBeforeSampling=x

x= time (sec) to wait after switching on external voltages and RS-232 sensors before sampling (0-600 sec). **Default 0 sec.**

Typical values if using:

- WET Labs sensor with bio-wiper – approximately 4 sec, to provide time for bio-wiper to open (sensor dependent; see WET Labs documentation).
- SBE 43 or 63 oxygen sensor – time is dependent on membrane thickness and water temperature (see *Pump Operation*). Use with **PumpMode=2**.
- Beckman- or YSI-type oxygen sensor – 120-180 sec to provide time for sensor to polarize. Use with **PumpMode=2**.
- Sea Tech fluorometer - 15 sec to provide time for sensor to stabilize.

DelayAfterSampling=x

x= time (sec) to wait after sampling is completed, before turning off power to external voltages and RS-232 sensors (0 – 100 sec). **Default 0 sec.**

Typical value if using WET Labs sensor with bio-wiper is 4 sec, to allow time for sensor to shut bio-wiper after sampling is completed (sensor dependent; see WET Labs documentation).

Notes:

- The 16plus V2 requires verification when **SBE63=**, **SBE38=**, **SBE50=**, **WetLabs=**, **GTD=**, or **DualGTD=**, or **Optode=** is sent. The 16plus V2 responds: this command will change the scan length and/or initialize logging. Repeat the command to verify. Type the command again and press the Enter key to proceed. The 16plus V2 responds: Scan length has changed, initializing logging
- The 16plus V2 configuration (.xmlcon or .con) file must match this selection of RS-232 sensor when viewing real-time data or processing uploaded data. View and edit the configuration file in Seasave or SBE Data Processing. These parameters are factory-set to match the ordered instrument configuration.
- See the RS-232 sensor manual for its command details.

Note:

You can use Seaterm232 to communicate directly with the SBE 63 when it is connected directly to the computer.

Note:

The 16plus V2 sample interval (**SampleInterval=**) must be greater than or equal to the sum of the times required to sample. Total time is affected by the following:

- Minimum time required for 16plus V2 to take a CTD sample and to request and receive a sample from SBE 63 (≈ 10 sec).
- Time required for integration of optional Quartz pressure sensor (**ParosIntegration=**).
- Time required for 16plus V2 to take and average **NCycles=** samples; samples are taken 0.25 sec apart.
- Delay after providing power to external sensors before sampling (**DelayBeforeSampling=**); when used with the SBE 63, minimum **DelayBeforeSampling=** is 25 sec at 15 °C to 40 sec at 0 °C (linear interpolation between those values). This provides enough time for the SBE 63 to equilibrate after pumping begins, before the measurement is made.
- Delay after sampling before turning off power to external sensors (**DelayAfterSampling=**).

RS-232 Sensor Setup Commands

The 16plus V2 can interface with one of the following RS-232 instruments (connected to the 4-pin *Auxiliary RS-232 Input* bulkhead connector on the 16plus V2 end cap):

- SBE 63 optical dissolved oxygen sensor
- SBE 38 secondary temperature sensor
- SBE 50 pressure sensor
- WET Labs single, dual, or triple channel ECO sensor; WETStar; or C-Star
- Pro-Oceanus Gas Tension Devices (up to two GTDs can be integrated)
- Aanderaa Oxygen Optode 4330 or 4835

Setup for SBE 63:

Set up SBE 63 to interface with SBE 16plus V2, **before** you connect it to 16plus V2. Connect SBE 63 directly to computer, power with an external power supply, and (using Seaterm232) set the following parameters:

- Set baud rate to same baud rate as 16plus V2 (**SetBaud=**)
- Set samples averaged to 1 to 16; default value of 2 recommended (**SetAvg=2**)
- Set output format for compatibility with 16plus V2 (**SetFormat=1**)
- Disable automatic sampling when power applied (**SetAutoRun=0**)

Connect SBE 63 to SBE 16plus V2 *Auxiliary RS-232 Input* connector, using provided cable. In the 16plus V2, set **SBE63=Y** to enable interface.

SBE63=x

x=Y: Enable SBE 63 optical dissolved oxygen sensor.

x=N: Do not enable SBE 63.

Send63=command

Command 16plus V2 to send **command** to SBE 63 and receive response; **command** can be any command recognized by SBE 63 (see SBE 63 manual).

RS-232 Sensor Setup Commands (*continued*)**Note:**

You can use Seaterm232 to communicate directly with the SBE 38 when it is connected directly to the computer. Alternatively, use the older Seaterm software, as documented in the SBE 38 manual.

Setup for SBE 38:

Set up SBE 38 to interface with SBE 16plus V2, **before** you connect it to 16plus V2. Connect SBE 38 directly to computer, power with an external power supply, and (using Seaterm or Seaterm232) set:

- **Baud rate** to same baud rate as 16plus V2 (**Baud=**)
- **Interface** to RS-232 (**Interface=232**)
- **Sampling** to begin when power applied (**AutoRun=Y**)
- **Output** to converted data (**Format=C**)

Connect SBE 38 to SBE 16plus V2 *Auxiliary RS-232 Input* connector, using provided cable. In the 16plus V2, set **SBE38=Y** to enable interface.

SBE38=x

x=Y: Enable SBE 38 secondary temperature sensor.

x=N: Do not enable SBE 38.

Note:

You can use Seaterm232 to communicate directly with the SBE 50 when it is connected directly to the computer. Alternatively, use the older Seaterm software, as documented in the SBE 50 manual.

Setup for SBE 50:

Set up SBE 50 to interface with SBE 16plus V2, **before** you connect it to 16plus V2. Connect SBE 50 directly to computer, power with an external power supply, and (using Seaterm or Seaterm232) set:

- **Baud rate** to same baud rate as 16plus V2 (**Baud=**).
- **Output** to converted data in psia, decibars, meters, or feet (**OutputFormat= 1, 2, 3, 4, 5, or 6**).

Note: **If you will be using Seasave or SBE Data Processing**, you **must** set the SBE 50 format to psia (**OutputFormat=1**).

Connect SBE 50 to SBE 16plus V2 *Auxiliary RS-232 Input* connector, using provided cable. In the 16plus V2, set **SBE50=Y** to enable interface.

SBE50=x

x=Y: Enable SBE 50 pressure sensor.

x=N: Do not enable SBE 50.

RS-232 Sensor Setup Commands (*continued*)**Note:**

The 16plus V2 sample interval (**SampleInterval=**) must be greater than or equal to the sum of the times required to sample. Total time is affected by the following:

- Minimum time required for 16plus V2 to take a sample (≈ 2.5 sec).
- Time required for integration of optional Quartz pressure sensor (**ParosIntegration=**).
- Time required for 16plus V2 to take and average **NCycles=** samples; samples are taken 0.25 sec apart.
- Delay after providing power to external sensors before sampling (**DelayBeforeSampling=**); *minimum DelayBeforeSampling= is 2 sec if using a WET Labs RS-232 sensor.*
- Delay after sampling before turning off power to external sensors (**DelayAfterSampling=**).
- Time required to run pump before sampling (0.5 sec if **PumpMode=1**).

Setup for WET Labs Sensor

(*single, dual, or triple ECO Sensor; WETStar, or C-Star*):

- **16plus V2** must be set to 19200 baud (**BaudRate=19200**) if interfacing with a WET Labs RS-232 sensor.
- **16plus V2 DelayBeforeSampling=** must be ≥ 2 sec if using a WET Labs RS-232 sensor. If **WetLabs=Y** and **DelayBeforeSampling** < 2 sec, 16plus V2 automatically sets **DelayBeforeSampling=2**.
- If using a WET Labs sensor with a bio-wiper – set **16plus V2 DelayBeforeSampling=** and **DelayAfterSampling=** to enough time to allow bio-wiper to open before sampling and to close after sampling. Sea-Bird typically sets these parameters to 4.0 sec for use with a sensor with a bio-wiper (sensor dependent).

Note that the SBE 16plus V2 stores and outputs 6 bytes of WET Labs RS-232 data for each sample. If integrating an ECO Triplet, each sensor of the Triplet uses 2 bytes (for a total of 6 bytes). If integrating a dual ECO sensor (such as the FLNTU), the first 4 bytes contain the sensor data; the remaining 2 bytes are 0's. For single WET Labs RS-232 sensors, the first 2 bytes contain the sensor data; the remaining 4 bytes are 0's.

WetLabs=x

x=Y: Enable WET Labs RS-232 sensor.

x=N: Do not enable WET Labs RS-232 sensor.

RS-232 Sensor Setup Commands (continued)**Note:**

The 16plus V2 sample interval (**SampleInterval=**) must be greater than or equal to the sum of the times required to sample. Total time is affected by the following:

- **Programmable pressure integration time for GTD.**
- **Programmable temperature integration time for GTD.**
- Minimum time required for 16plus V2 to take a sample (≈ 2.5 sec).
- Time required for integration of optional Quartz pressure sensor (**ParosIntegration=**).
- Time required for 16plus V2 to take and average **NCycles=** samples; samples are taken 0.25 sec apart.
- Delay after providing power to external sensors before sampling (**DelayBeforeSampling=**).
- Delay after sampling before turning off power to external sensors (**DelayAfterSampling=**)
- Time required to run pump before sampling (0.5 sec if **PumpMode=1**).

Setup for GTD:

Set up GTD to interface with 16plus V2, **before** you connect it to 16plus V2. Connect GTD directly to computer, power with an external power supply, and (using software provided by Pro-Oceanus) set:

- **Baud rate** to same baud rate as 16plus V2.
- **Output** to millibars.
- Sum of **pressure integration time** and **temperature integration time** so that the GTD responds to a *take pressure reading* command in 40 sec or less (required so that 16plus V2 does not *time out* while waiting for reply).

Connect GTD to 16plus V2 *Auxiliary RS-232 Input* connector, using provided cable (end labeled *Pro-Oceanus* to GTD; end labeled *Sea-Bird* to 16plus V2). In the 16plusV2, set:

- **GTD=Y** or **DualGTD=Y** to enable interface.
- **SendGTD=** to change IDs if necessary.

The 16plus V2 samples the GTD last, after **DelayBeforeSampling=**, and after conductivity, temperature, and pressure, and all voltage channels have been sampled. To conserve power, the voltage to any other external sensors and the pump are turned off before acquiring the GTD sample.

Each time a sample is to be taken, SBE 16plus V2 sends following commands to GTD (ID= 01, 02, etc.):

- ***ID00VR** <CR><LF> - get GTD firmware version; wait up to 3 sec for reply.
- ***ID00SN** <CR><LF> - get GTD serial number; wait up to 5 sec for reply.
- ***9900P5** <CR><LF> - command all GTDs to sample pressure; hold data in GTD.
- ***ID00DB** <CR.<LF> - get held pressure; wait up to 90 sec for reply.
- ***9900Q5** <CR><LF> - command all GTDs to sample temperature; hold data in GTD.
- ***ID00DB** <CR.<LF> - get held temperature; wait up to 90 sec for reply.

Notes:

- A 16plus V2 with dual GTDs is shipped with a Y-cable installed for the GTDs. The GTD ends are labeled GTD #1 and #2, and Sea-Bird set the GTD IDs to match.
- If **DualGTD=Y**, setting for **GTD=** has no effect.

GTD=x**x=Y:** Enable GTD.**x=N:** Do not enable GTD.**DualGTD=x****x=Y:** Enable dual (2) GTDs.**x=N:** Do not enable dual GTDs.**TGTD**

Measure GTD(s), output 1 sample of data from each GTD (firmware version, serial number, pressure, and temperature).

Example: Output GTD data for system with dual GTDs (user input in bold):

TGTD

```
GTD#1 VR reply = *0001VR=s2.03 (GTD firmware version)
GTD#2 VR reply = *0002VR=s2.03 (GTD firmware version)
GTD#1 SN reply = *0001SN = 75524 (GTD serial number)
GTD#2 SN reply = *0002SN = 81440 (GTD serial number)
GTD#1 pressure reply = *00011010.04661, p = 101004661 (millibars x 105)
GTD#2 pressure reply = *00021010.01580, p = 101001580 (millibars x 105)
GTD#1 temperature reply = *000123.49548, t = 23.4955 (°C)
GTD#2 temperature reply = *000223.0357038, t = 23.0357 (°C)
```

SendGTD=commandCommand 16plus V2 to send **command** to GTD and receive response; **command** can be any command recognized by GTD (see GTD manual).

Examples: (user input in bold)

Send firmware version command to GTD #1:

SENDGTD=*0100vr

Sending GTD: **0100vr

GTD RX = *0001VR=s2.03

Send serial number command to GTD #2:

SENDGTD=*0200sn

Sending GTD: **0200sn

GTD RX = *0002SN=81440

Output Format Setup Commands

See *Data Output Formats* after the command descriptions for complete details on all the formats.

Note:

Output format does not affect how data is stored in FLASH memory. Sea-Bird's real-time data acquisition (Seasave) and data processing (SBE Data Processing) software require data in raw hexadecimal (**OutputFormat=0**).

Typical use of the output format command is:

- Before beginning logging:
 - **If you will use Seasave to view real-time data** - Set output format to raw hex.
 - **If you will use Seaterm232 to view real-time data** - Set output format to converted decimal for ease in viewing real-time data.
- After stopping sampling, use Seaterm232's Upload menu to upload data from memory. This automatically uploads the data in raw hex (regardless of the **OutputFormat=** setting), so the uploaded data is compatible with SBE Data Processing for processing and with Seasave for viewing archived data.

OutputFormat=x

x=0: Output raw frequencies and voltages in hexadecimal. **Must use this format for acquiring and viewing real-time data in Seasave.** When using Seaterm232's Upload menu, Seaterm232 always uploads data from memory in raw hex (compatible with SBE Data Processing), regardless of user-programmed **OutputFormat=**.

x=1: Output converted (engineering units) data in hexadecimal.

x=2: Output raw frequencies and voltages in decimal.

x=3: Output converted (engineering units) data in decimal.

x=4: Not a valid output format.

x=5: Output converted (engineering units) data in decimal, in XML.

OutputSal=x

x=Y: Calculate and output salinity (psu). Only applies if **OutputFormat=3** or **5**.

x=N: Do not.

OutputSV=x

x=Y: Calculate and output sound velocity (m/sec), using Chen and Millero formula (UNESCO Technical Papers in Marine Science #44). Only applies if **OutputFormat=3** or **5**.

x=N: Do not.

OutputUCSD=x

x=Y: Calculate and output density sigma-t (kg/m^3), battery voltage, and operating current (mA) with data polled while logging. Voltage and current measured after delay before sampling, but before sampling. Only applies if **OutputFormat=3** or **5**.

x=N: Do not.

Polled Sampling Commands

Notes:

- The 16plus V2 has a buffer that stores the most recent data samples. Unlike data in the FLASH memory, data in the buffer is erased upon removal or failure of power.
- *Leave power on* in **SL**, **SLT**, **TS**, and **TSSOn** descriptions refers to power for the 16plus V2 as well as for a pump and any auxiliary sensors. Power remains on until **QS** is sent or the instrument times out (after 2 minutes).

These commands request a single sample (with the exception of **GetLastSamples:x**). The 16plus V2 always stores data for the most recent sample in its buffer. Some polled sampling commands also store data in FLASH memory - the 16plus V2 will not execute the *store data in FLASH memory* portion of those commands while sampling autonomously.

SL	Output last sample from buffer (obtained with polled sampling command, or latest sample from autonomous sampling), and leave power on.
SLT	Output last sample from buffer, then take new sample and store data in buffer. Leave power on. Data is not stored in FLASH memory.
TS	Take new sample, store data in buffer, output data, and leave power on. Data is not stored in FLASH memory.
TSS	Take new sample, store data in buffer and FLASH memory , output data, and turn power off.
TSSOn	Take new sample, store data in buffer and FLASH memory , output data, and leave power on.
GetLastSamples:x	Output last x samples from FLASH memory. If x is greater than the number of samples in memory, 16plus V2 outputs all samples in memory. If x is omitted, 16plus V2 outputs just the last sample. You do not need to stop logging (Stop) before sending GetLastSamples:x.

Serial Line Sync Commands

Note:

See *Sampling Modes*.

SyncMode=x	x=Y : Enable serial line synchronization. When RS-232 RX line is high (3-10 VDC) for 1 to 1000 millisecond, 16plus V2 takes a sample, stores data in FLASH memory, transmits real-time data (if TxRealTime=Y), and powers down. x=N : Disable serial line synchronization.
SyncWait=x	x = time (sec) 16plus V2 monitors RS-232 line for commands after taking a sample in serial line sync mode. Range 0 - 120 sec; default 0.

Data Upload Commands

Notes:

- **Use Seaterm232's Upload menu to upload data that will be processed by SBE Data Processing or viewed in Seasave.** Manually entering a data upload command does not produce data with the required header information for processing by our software. These commands are included here for reference for users who are writing their own software.
- **If not using Seaterm232's Upload menu** - To save data to a file, click the Capture menu before entering a data upload command.
- See *Data Output Formats*.

Stop sampling autonomously before uploading data.

If manually sending a data upload command, data is uploaded in the format defined by **OutputFormat=**.

GetSamples:b,e or **DDb,e** Upload data from sample **b** to sample **e**.
If **b** and **e** are omitted, all data is uploaded.
First sample number is 1.

Examples: Upload samples 1 to 1000 to a file (user input in bold):
(Click Capture menu and enter desired filename in dialog box.)

GETSAMPLES : 1 , 1000

or

DD1 , 1000

GetHeaders:b,e or **DHb,e** Upload header **b** to header **e**. If **b** and **e** are omitted, all headers are uploaded. First header number is 1. Header includes:

- header number
- month, day, hour, minute, and second when header was written
- first and last sample for header
- interval between samples (**SampleInterval=**)
- reason logging was halted
(batfail = battery voltage too low;
stop cmd = received **Stop** command or Home or Ctrl Z character;
timeout = error condition;
unknown = error condition;
?????? = error condition)

Example: Upload second header to a file (user input in bold):
(Click Capture menu and enter desired filename in dialog box.)

GETHEADERS : 2 , 2

or

DH2 , 2

16plus V2 responds:

hdr 2 30 Jan 2012 12:30:33 samples 35 to 87, int=60, stop=stop cmd

Testing Commands

The 16plus V2 takes and outputs **100 samples** for each test (except as noted); data is **not** stored in FLASH memory. Press the Esc key (or send a break character) to stop a test.

Note:

If your 16plus V2 includes an optional pump:

Testing commands do not automatically turn the pump on. Thus, for sensors plumbed with the pump, they report data from essentially the same sample of water for all 100 measurements, because the pump does not run but the pump and associated plumbing prevent water from freely flowing through the conductivity cell and other plumbed sensors (for example, dissolved oxygen sensor). To get data from fresh samples, send **PumpOn** before sending a testing command, and then send **PumpOff** when the test is complete.

- TC** Measure conductivity, output converted data.
- TCR** Measure conductivity, output raw data.
- TT** Measure temperature, output converted data.
- TTR** Measure temperature, output raw data.
- TP** Measure internally mounted pressure (strain gauge or Quartz), output converted data.
- TPR** Measure internally mounted pressure (strain gauge or Quartz), output raw data.
- TV** Measure 6 external voltage channels, output converted data.
- TVR** Measure voltages read by A/D converter, output raw data:

Column	Output
1-6	External voltages
7	Main battery voltage / 11
8	Back-up lithium battery voltage / 3.741
9	External current / 333.33
10	Pressure temperature voltage

- TF** Measure frequency (internally mounted Quartz pressure sensor), output converted pressure data.
- TFR** Measure frequency (internally mounted Quartz pressure sensor), output raw data.
- T63** Measure SBE 63 optical dissolved oxygen, output aa.aaaa, b.bbbb, o.oooo, tt.tttt *where*
 aa.aaaa = phase (µsec)
 b.bbbb = temperature voltage
 o.oooo = dissolved oxygen (ml/l)
 tt.tttt = temperature in (°C)
- T38** Measure SBE 38 (secondary temperature), output converted data.
- T50** Measure SBE 50 pressure, output converted data.

Testing Commands *continued***TWetLabs**

Measure WET Labs RS-232 sensor. Output varies, depending on sensor type.

ECO triple sensor:

Column	Output
1 – 2	Date and time
3	Wavelength sensor 1
4	Raw signal counts sensor 1
5	Wave length sensor 2
6	Raw signal counts sensor 2
7	Wave length sensor 3
8	Raw signal counts sensor 3
9	Thermistor counts

ECO dual sensor:

Column	Output
1 – 2	Date and time
3	Wavelength sensor 1
4	Raw signal counts sensor 1
5	Wave length sensor 2
6	Raw signal counts sensor 2
7	Thermistor counts

ECO single sensor:

Column	Output
1 – 2	Date and time
3	Wavelength sensor 1
4	Raw signal counts sensor 1
5	Thermistor counts

WETStar: Counts***C-Star:***

Column	Output
1	Sensor serial number
2	Reference counts
3	Signal counts
4	Corrected signal raw counts
5	Calculated beam c, inverse meters
6	Internal thermistor, counts

TOptode

Measure Aanderaa Optode, output product number, serial number, and dissolved oxygen (micromoles/liter).

PumpOn

Turn pump on for testing purposes. Use this command:

- Before sending testing command to obtain pumped data from sensors plumbed with the pump, or
- To test pump.

PumpOff

Turn pump off for testing purposes.

Calibration Coefficients Commands

Calibration coefficients are initially factory-set and should agree with Calibration Certificates shipped with the 16plus V2.

Notes:

- F = floating point number
S = string with no spaces
- Auxiliary sensor calibration coefficients are not stored in the 16plus V2 EEPROM.
 - Calibration coefficients for sensors that output raw data are stored in the 16plus V2 configuration (.xmlcon or .con) file. View and/or modify the calibration coefficients using the Configure menu in SBE Data Processing or the Configure Inputs menu in Seasave.
 - Some RS-232 auxiliary sensors store their calibration coefficients internally, and can output data in engineering units. For the SBE 63, view and/or modify the instrument's calibration coefficients by sending **Send63=** to the SBE 63 *through* the 16plus V2. For other Sea-Bird auxiliary sensors such as the SBE 38 or SBE 50, view and/or modify the instrument's calibration coefficients by connecting the instrument to the computer directly and using Seaterm, our older terminal program software (not Seaterm232).

Temperature

TCalDate=S	S=calibration date
TA0=F	F=A0
TA1=F	F=A1
TA2=F	F=A2
TA3=F	F=A3
TOffset=F	F=offset correction

Conductivity

CCalDate=S	S=calibration date
CG=F	F=G
CH=F	F=H
CI=F	F=I
CJ=F	F=J
PCor=F	F=pcor
TCor=F	F=tcor
CSlope=F	F=slope correction

Internally Mounted Pressure - General

PCalDate=S	S=calibration date
PRange=F	F=sensor full scale range (psia)
POffset=F	F=offset correction (decibars)

Internally Mounted Strain Gauge Pressure

PA0=F	F=A0
PA1=F	F=A1
PA2=F	F=A2
PTempA0=F	F=pressure temperature A0
PTempA1=F	F=pressure temperature A1
PTempA2=F	F=pressure temperature A2
PTCA0=F	F=pressure temperature compensation ptca0
PTCA1=F	F=pressure temperature compensation ptca1
PTCA2=F	F=pressure temperature compensation ptca2
PTCB0=F	F=pressure temperature compensation ptcb0
PTCB1=F	F=pressure temperature compensation ptcb1
PTCB2=F	F=pressure temperature compensation ptcb2

Internally Mounted Quartz Pressure

PC1=F	F=C1
PC2=F	F=C2
PC3=F	F=C3
PD1=F	F=D1
PD2=F	F=D2
PT1=F	F=T1
PT2=F	F=T2
PT3=F	F=T3
PT4=F	F=T4
PSlope=F	F=slope correction

Hardware Configuration Commands

The following commands are used to set auxiliary channel sensor types (description such as *oxygen*, *fluorometer*, etc.) and serial number.

Auxiliary Voltage Sensor Settings – can be modified in the field to accommodate changes in auxiliary voltage sensors cabled to the 16plus V2

SetVoltType0=

SetVoltSN0=

SetVoltType1=

SetVoltSN1=

SetVoltType2=

SetVoltSN2=

SetVoltType3=

SetVoltSN3=

SetVoltType4=

SetVoltSN4=

SetVoltType5=

SetVoltSN5=

Auxiliary RS-232 Sensor Settings – can be modified in the field to accommodate changes in auxiliary RS-232 sensors cabled to the 16plus V2

SetSerialType=

SetSerialSN=

Data Output Formats

Note:

For the date and time output, time is the time at the **start** of the sample, after:

- a small amount of time (1 to 2 sec) for the 16plus V2 to wake up and prepare to sample, and
- any programmed **DelayBeforeSampling=**.

For example, if the 16plus V2 is programmed to wake up and sample at 12:00:00, and **DelayBeforeSampling=20**, the output time for the first sample will be 12:00:21 or 12:00:22.

The SBE 16plus V2 stores data in a compact machine code. Data is converted and output in the user-selected format without affecting data in memory. Because memory data remains intact until deliberately overwritten, you can upload in one format, then choose another format and upload again.

Output format is dependent on **OutputFormat= (0, 1, 2, 3, or 5)** and on the command used to retrieve the data, as detailed below. The inclusion of some data is dependent on the system configuration - if the system does not include the specified sensor, the corresponding data is not included in the output data stream, shortening the data string. RS-232 sensors always output data in the same format, regardless of **OutputFormat=**:

- SBE 63 data is always output as phase delay and temperature voltage
- SBE 38, SBE 50, GTD, and Optode data is always output in engineering units.
- WET Labs RS-232 sensor data is always output in raw counts.

If outputting real-time data (**TxRealTime=Y**) for autonomous (logging) sampling or for serial line sync mode, a # sign precedes the real-time output for each sample.

Notes:

- If you will be using Seasave to acquire real-time data, you must set **OutputFormat=0**.
- When using Seaterm232's Upload menu, Seaterm232 always uploads data from memory in raw hex, regardless of the user-programmed format, providing the data in a format that SBE Data Processing can use.
- Our software uses the equations shown to perform these calculations; alternatively, you can use the equations to develop your own processing software.
- The internally mounted pressure sensor is an absolute sensor, so its **raw** output includes the effect of atmospheric pressure (14.7 psi). As shown on the Calibration Sheet, Sea-Bird's calibration (and resulting calibration coefficients) is in terms of psia. However, when outputting pressure in **engineering units**, the 16plus V2 outputs pressure relative to the ocean surface (i.e., at the surface the output pressure is 0 decibars). The 16plus V2 uses the following equation to convert psia to decibars:
pressure (db) =
[pressure (psia) - 14.7] * 0.689476
- SBE 50 units are dependent on **OutputFormat=** programmed into the SBE 50; if you will be using Seasave or SBE Data Processing, you must set the SBE 50 format to psia (**OutputFormat=1**).

OutputFormat=0 (raw frequencies and voltages in Hex)

Data is output in the order listed, with no spaces or commas between parameters. Shown with each parameter is the number of digits, and how to calculate the parameter from the data (use the decimal equivalent of the hex data in the equations).

1. Temperature A/D counts = ttttt
2. Conductivity frequency (Hz) = cccccc / 256
3. (if **PType=1**) Internally mounted strain gauge pressure sensor pressure A/D counts = pppppp
4. (if **PType=1**) Internally mounted strain gauge pressure sensor pressure temperature compensation voltage = vvvv / 13,107
5. (if **PType=3**) Internally mounted Quartz pressure sensor pressure frequency (Hz) = pppppp / 256
6. (if **PType=3**) Internally mounted Quartz pressure sensor temperature compensation voltage = vvvv / 13,107
7. (if **Volt0=Y**) External voltage 0 = vvvv / 13,107
8. (if **Volt1=Y**) External voltage 1 = vvvv / 13,107
9. (if **Volt2=Y**) External voltage 2 = vvvv / 13,107
10. (if **Volt3=Y**) External voltage 3 = vvvv / 13,107
11. (if **Volt4=Y**) External voltage 4 = vvvv / 13,107
12. (if **Volt5=Y**) External voltage 5 = vvvv / 13,107
13. (if **SBE38=Y**) SBE 38 temperature (°C, ITS-90) = (ttttt / 100,000) - 10
14. (if **SBE50=Y**) SBE 50 pressure (decibars, psia, meters, or feet)
= (pppppp / 10,000) - 100
15. (if **WetLabs=Y**) WET Labs RS-232 sensor = wwwwxxyyyy
where wwww, xxxx, and yyyy are raw signal counts for each sensor;
yyyy all 0's for dual sensor; xxxx and yyyy all 0's for single sensor
16. (if **GTD=Y** or **DualGTD=Y**)
GTD #1 pressure (millibars) = pppppppp / 100,000
17. (if **GTD=Y** or **DualGTD=Y**)
GTD #1 temperature (°C, ITS-90) = (ttttt / 100,000) - 10
18. (if **DualGTD=Y**)
GTD #2 pressure (millibars) = pppppppp / 100,000
19. (if **DualGTD=Y**)
GTD #2 temperature (°C, ITS-90) = (ttttt / 100,000) - 10
20. (if **Optode=Y**) Optode oxygen (micromoles/liter) = (ooooo / 10,000) - 10
21. (if **SBE63=Y**) SBE 63 oxygen phase (µsec) = (ooooo / 100,000) - 10
22. (if **SBE63=Y**) SBE 63 oxygen temperature voltage = (ttttt / 1,000,000) - 1
23. Time
seconds since January 1, 2000 = ssssssss

Example: 16plus V2 with internally mounted strain gauge pressure sensor and 2 external voltages sampled,
example scan = tttttccccppppppvvvvvvvvvvvvsssssss = 0A53711BC7220C14C17D82030505940EC4270B

- Temperature = ttttt = 0A5371 (676721 decimal); temperature A/D counts = 676721
- Conductivity = 1BC722 (1820450 decimal); conductivity frequency = 1820450 / 256 = 7111.133 Hz
- Internally mounted strain gauge pressure = pppppp = 0C14C1 (791745 decimal);
Strain gauge pressure A/D counts = 791745
- Internally mounted strain gauge temperature compensation = vvvv = 7D82 (32,130 decimal);
Strain gauge temperature = 32,130 / 13,107 = 2.4514 volts
- First external voltage = vvvv = 0305 (773 decimal); voltage = 773 / 13,107 = 0.0590 volts
- Second external voltage = vvvv = 0594 (1428 decimal); voltage = 1428 / 13,107 = 0.1089 volts
- Time = ssssssss = 0EC4270B (247,736,075 decimal); seconds since January 1, 2000 = 247,736,075

OutputFormat=1 (engineering units in Hex)

Data is output in the order listed, with no spaces or commas between the parameters. Shown with each parameter is the number of digits, and how to calculate the parameter from the data (use the decimal equivalent of the hex data in the equations).

1. Temperature (°C, ITS-90) = (ttttt / 100,000) - 10
2. Conductivity (S/m) = (ccccc / 1,000,000) - 1
3. (strain gauge or Quartz - **PType=1** or **3**)
Internally mounted pressure (decibars) = (pppppp / 1,000) - 100
4. (if **Volt0=Y**) External voltage 0 = vvvv / 13,107
5. (if **Volt1=Y**) External voltage 1 = vvvv / 13,107
6. (if **Volt2=Y**) External voltage 2 = vvvv / 13,107
7. (if **Volt3=Y**) External voltage 3 = vvvv / 13,107
8. (if **Volt4=Y**) External voltage 4 = vvvv / 13,107
9. (if **Volt5=Y**) External voltage 5 = vvvv / 13,107
10. (if **SBE38=Y**)
SBE 38 temperature (°C, ITS-90) = (ttttt / 100,000) - 10
11. (if **SBE50=Y**)
SBE 50 pressure (dbars, psia, meters, or feet) = (pppppp / 10,000) - 100
12. (if **WetLabs=Y**) WET Labs RS-232 sensor = wwwxxxxxyyyy
where www, xxxx, and yyyy are raw signal counts for each sensor;
yyyy all 0's for dual sensor; xxxx and yyyy all 0's for single sensor
13. (if **GTD=Y** or **DualGTD=Y**)
GTD #1 pressure (millibars) = ppppppp / 100,000
14. (if **GTD=Y** or **DualGTD=Y**)
GTD #1 temperature (°C, ITS-90) = (ttttt / 100,000) - 10
15. (if **DualGTD=Y**)
GTD #2 pressure (millibars) = ppppppp / 100,000
16. (if **DualGTD=Y**)
GTD #2 temperature (°C, ITS-90) = (ttttt / 100,000) - 10
17. (if **Optode=Y**) Optode oxygen (micromoles/liter) = (oooooo / 10,000) - 10
18. (if **SBE63=Y**) SBE 63 oxygen phase (µsec) = (oooooo / 100,000) - 10
19. (if **SBE63=Y**) SBE 63 oxygen temperature voltage = (ttttt / 1,000,000) - 1
20. Time
seconds since January 1, 2000 = sssssss

Note:

SBE 50 units are dependent on **OutputFormat=** programmed into the SBE 50.

Example: 16plus V2 with internally mounted strain gauge pressure sensor and 2 external voltages sampled,
example scan = tttttccccppppppvvvvvvvsssssss
= 3385C40F42FE0186DE030505940EC4270B

- Temperature = ttttt = 3385C4 (3376580 decimal);
temperature (°C, ITS-90) = (3376580 / 100,000) - 10 = 23.7658
- Conductivity = ccccc = 0F42FE (1000190 decimal);
conductivity (S/m) = (1000190 / 1,000,000) - 1 = 0.00019
- Internally mounted pressure = pppppp = 0186DE (100062 decimal);
pressure (decibars) = (100062 / 1,000) - 100 = 0.062
- First external voltage = vvvv = 0305 (773 decimal); voltage = 773 / 13,107 = 0.0590 volts
- Second external voltage = vvvv = 0594 (1428 decimal); voltage = 1428 / 13,107 = 0.1089 volts
- Time = sssssss = 0EC4270B (247,736,075 decimal)
seconds since January 1, 2000 = 247,736,075

OutputFormat=2 (raw frequencies and voltages in decimal)

Data is output in the order listed, with a comma followed by a space between each parameter. Shown with each parameter are the number of digits and the placement of the decimal point. Leading zeros are suppressed, except for one zero to the left of the decimal point.

1. Temperature A/D counts = ttttt
2. Conductivity frequency (Hz) = cccc.ccc
3. (if **PType=1**) Internally mounted strain gauge pressure sensor pressure A/D counts = pppppp
4. (if **PType=1**) Internally mounted strain gauge pressure sensor pressure temperature compensation voltage = v.vvvv
5. (if **PType=3**) Internally mounted Quartz pressure sensor pressure frequency (Hz) = ppppp.ppp
6. (if **PType=3**) Internally mounted Quartz pressure sensor temperature compensation voltage = v.vvvv
7. (if **Volt0=Y**) External voltage 0 = v.vvvv
8. (if **Volt1=Y**) External voltage 1 = v.vvvv
9. (if **Volt2=Y**) External voltage 2 = v.vvvv
10. (if **Volt3=Y**) External voltage 3 = v.vvvv
11. (if **Volt4=Y**) External voltage 4 = v.vvvv
12. (if **Volt5=Y**) External voltage 5 = v.vvvv
13. (if **SBE38=Y**) SBE 38 temperature (°C, ITS-90) = ttt.ttt
14. (if **SBE50=Y**) SBE 50 pressure (decibars, psia, meters, or feet) = pppp.ppp
15. (if **WetLabs=Y**) WET Labs RS-232 sensor = wwww, xxxx, yyyy
where wwww, xxxx, and yyyy are raw signal counts for each sensor;
yyyy all 0's for dual sensor; xxxx and yyyy all 0's for single sensor
16. (if **GTD=Y** or **DualGTD=Y**) GTD #1 pressure (millibars)
= ppppppppp / 100,000
17. (if **GTD=Y** or **DualGTD=Y**) GTD #1 temperature (°C, ITS-90) = tt.ttt
18. (if **DualGTD=Y**) GTD #2 pressure (millibars) = ppppppppp / 100,000
19. (if **DualGTD=Y**) GTD #2 temperature (°C, ITS-90) = tt.ttt
20. (if **Optode=Y**) Optode oxygen (micromoles/liter) = oooo.ooo
21. (if **SBE63=Y**) SBE 63 oxygen phase (µsec) = oo.ooo
22. (if **SBE63=Y**) SBE 63 oxygen temperature voltage = t.ttttt
23. Time
date, time = dd Mmm yyyy, hh:mm:ss (day month year hour:minute:second)

Note:

SBE 50 units are dependent on **OutputFormat=** programmed into the SBE 50.

Example: 16plus V2 with internally mounted strain gauge pressure sensor and 2 external voltages sampled,
example scan = ttttt, cccc.ccc, pppppp, v.vvvv, v.vvvv, v.vvvv, dd mmm yyyy, hh:mm:ss
= 676721, 7111.133, 791745, 2.4514, 0.0590, 0.1089, 7 Nov 2007, 07:34:35

- Temperature = ttttt = 676721; temperature A/D counts = 676721
- Conductivity = cccc.ccc = 7111.133; conductivity frequency = 7111.133 Hz
- Internally mounted strain gauge pressure = pppppp = 791745; Strain gauge pressure A/D counts = 791745
- Internally mounted strain gauge temperature compensation = v.vvvv = 2.4514; Strain gauge temperature = 2.4514 volts
- First external voltage = v.vvvv = 0.0590; voltage = 0.0590 volts
- Second external voltage = v.vvvv = 0.1089; voltage = 0.1089 volts
- Date, time = dd Mmm yyyy, hh:mm:ss = 7 Nov 2007, 07:34:35 Date, time = 7 November 2007, 07:34:35

OutputFormat=3 (engineering units in decimal)

Data is output in the order listed, with a comma followed by a space between each parameter. Shown with each parameter are the number of digits and the placement of the decimal point. Leading zeros are suppressed, except for one zero to the left of the decimal point.

Uploaded Data (from GetSamples:b,e, or DDb,e):

1. Temperature (°C, ITS-90) = ttt.tttt
2. Conductivity (S/m) = cc.ccccc
3. (strain gauge or Quartz - PType=1 or 3)
Internally mounted pressure (decibars) = pppp.ppp
4. (if Volt0=Y) External voltage 0 = v.vvvv
5. (if Volt1=Y) External voltage 1 = v.vvvv
6. (if Volt2=Y) External voltage 2 = v.vvvv
7. (if Volt3=Y) External voltage 3 = v.vvvv
8. (if Volt4=Y) External voltage 4 = v.vvvv
9. (if Volt5=Y) External voltage 5 = v.vvvv
10. (if SBE38=Y) SBE 38 secondary temperature (°C, ITS-90) = ttt.tttt
11. (if SBE50=Y) SBE 50 pressure (dbars, psia, meters, or feet) = pppp.ppp
12. (if WetLabs=Y) WET Labs RS-232 sensor = wwwww, xxxxx, yyyy
where wwwww, xxxxx, and yyyy are raw signal counts for each sensor;
yyyy all 0's for dual sensor; xxxxx and yyyy all 0's for single sensor
13. (if GTD=Y or DualGTD=Y) GTD #1 pressure (millibars)
= ppppppppp / 100,000
14. (if GTD=Y or DualGTD=Y) GTD #1 temperature (°C, ITS-90) = tt.ttt
15. (if DualGTD=Y) GTD #2 pressure (millibars) = ppppppppp / 100,000
16. (if DualGTD=Y) GTD #2 temperature (°C, ITS-90) = tt.ttt
17. (if Optode=Y) Optode oxygen (micromoles/liter) = ooooo.ooo
18. (if SBE63=Y) SBE 63 oxygen phase (µsec) = oo.ooo
19. (if SBE63=Y) SBE 63 oxygen temperature voltage = t.tttttt
20. (if OutputSal=Y) salinity (psu) = sss.ssss
21. (if OutputSV=Y) sound velocity (m/sec) = vvvv.vvv
22. Time
date, time = dd Mmm yyyy, hh:mm:ss (day month year hour:minute:second)

Note:

SBE 50 units are dependent on **OutputFormat=** programmed into the SBE 50.

Example: 16plus V2 with internally mounted strain gauge pressure sensor and 2 external voltages sampled,
example scan = ttt.tttt, cc.ccccc, pppp.ppp, v.vvvv, v.vvvv, dd mmm yyyy, hh:mm:ss
= 23.7658, 0.00019, 0.062, 0.0590, 0.1089, 7 Nov 2007, 07:34:35

- Temperature = ttt.tttt = 23.7658; temperature (°C, ITS-90) = 23.7658
- Conductivity = cc.ccccc = 0.00019; conductivity (S/m) = 0.00019
- Internally mounted pressure = pppp.ppp = 0.062; pressure (decibars) = 0.062
- First external voltage = v.vvvv = 0.0590; voltage = 0.0590 volts
- Second external voltage = v.vvvv = 0.1089; voltage = 0.1089 volts
- Date, time = dd Mmm yyyy, hh:mm:ss = 7 Nov 2007, 07:34:35 Date, time = 7 November 2007, 07:34:35

Polled Data from SL, SLT, TS, TSS, or TSSOn:

If **OutputUCSD=Y** and the 16plus V2 is logging (autonomous sampling is in progress), data is followed by density sigma-t in kg/m³ (ddd.dddd), battery voltage (vv.v), and operating current in mA (ccc.c), each separated by a comma and a space. The rest of the data stream is as described above for uploaded data.

OutputFormat=5 (engineering units in decimal, in XML)**Note:**

OutputFormat=5 is listed in the **GetCD** and **DS** response as converted XML UVIC.

Data is output in the order listed, with **no** carriage return or line feed between each parameter (however, there is a carriage return and line feed at the end of the data stream, after the </datapacket> closing tag). Shown with each parameter are the number of digits and the placement of the decimal point. Leading zeroes are suppressed, except for one zero to the left of the decimal point.

Note:

For ease in reading, the data structure is shown with each XML tag on a separate line. However, there are no carriage returns or line feeds between tags (see example below).

Uploaded Data (from GetSamples:b,e or DDb,e):

```
<?xml?>
<datapacket>
<hdr>
<mfg>Sea-Bird</mfg>
<model>16plus</model>
<sn>nnnnnn</sn>
</hdr>
<data>
<t1>t.ttt</t1>
<c1>cc.ccccc</c1>
<p1>pppp.ppp </p1>
<v0>v.vvvv</v0>
<v1>v.vvvv</v1>
<v2>v.vvvv</v2>
<v3>v.vvvv</v3>
<v4>v.vvvv</v4>
<v5>v.vvvv</v5>
<ser1>
<type>sbe38, sbe50, wetlabs, gtd, Optode, or sbe63</type>
<t38>t.ttt</t38>
<p2>pppp.ppp</p2>
<w10>www</w10>
<w11>xxxx</w11>
<w12>yyyy</w12>
<p1>pppppppp</p1>
<t1>t.ttt</t1>
<p2>pppppppp</p2>
<t2>t.ttt</t2>
<oox>oooo.ooo</oox>
<oxph>oo.ooo</oxph>
<oxtv> t.ttttt</oxtv>
</ser1>
<sal>sss.ssss</sal>
<sv>vvvv.vvv</sv>
<dt>yyyy-mm-ddThh:mm:ss</dt>
</data>
</datapacket>
```

(if PType=1 or 3)
(if Volt0=Y)
(if Volt1=Y)
(if Volt2=Y)
(if Volt3=Y)
(if Volt4=Y)
(if Volt5=Y)

(type of RS-232 sensor)
(if SBE38=Y)
(if SBE50=Y)
(if WetLabs=Y)
(if WetLabs=Y)
(if WetLabs=Y)
(if GTD=Y or DualGTD=Y)
(if GTD=Y or DualGTD=Y)
(if DualGTD=Y)
(if DualGTD=Y)
(if Optode=Y)
(if SBE63=Y)
(if SBE63=Y)

(if OutputSal=Y)
(if OutputSV=Y)

where

Serial number = nnnnnnn
 Temperature (°C, ITS-90) = t.tttt
 Conductivity (S/m) = cc.ccccc
 Internally mounted pressure (decibars) = pppp.ppp
 External voltage = v.vvvv (for voltage 0, 1, 2, 3, 4, and 5)
 SBE 38 temperature (°C, ITS-90) = t.tttt
 SBE 50 pressure (decibars, psia, meters, or feet) = pppp.ppp
 WET Labs
 sensor 0 (raw signal counts) = wwwww
 sensor 1 (raw signal counts) = xxxx (= 0 unless using dual or triple sensor)
 sensor 2 (raw signal counts) = yyyy (= 0 unless using triple sensor)
 GTD pressure (millibars) = ppppppppp / 100,000 (for GTD #1 and #2)
 GTD temperature (°C, ITS-90) = t.ttt (for GTD #1 and #2)
 Optode oxygen (micromoles/liter) = oooo.ooo
 SBE 63 oxygen phase (µsec) = oo.ooo
 SBE 63 oxygen temperature voltage = t.ttttt
 Salinity (psu) = sss.ssss
 Sound velocity (m/sec) = vvvv.vvv
 Date, time = year month day T hour:minute:second (yyyy-mm-ddThh:mm:ss)

Note:

SBE 50 units are dependent on **OutputFormat=** programmed into the SBE 50.

Example: 16*plus* V2 with internally mounted strain gauge pressure sensor and 2 external voltages sampled, example scan =
 <?xml?><datapacket><hdr><mfg>Sea-Bird</mfg><model>16plus</model><sn>1606001</sn></hdr><data><t1>23.7658</t1><c1>0.00019</c1><p1>0.062</p1><v0>0.0590</v0><v1>0.1089</v1><dt>2007-11-07T07:34:35</dt></data></datapacket>CRLF
 Serial number = 1606001, Temperature (°C, ITS-90) = 23.7658, Conductivity (S/m) = 0.00019,
 Internally mounted pressure (decibars) = 0.062, First external voltage = 0.0590 volts, Second external voltage = 0.1089 volts,
 Date, time = November 7, 2007, 07:34:35

Polled Data from SL, SLT, TS, TSS, or TSSOn:

If **OutputUCSD=Y** and the 16*plus* V2 is logging (autonomous sampling is in progress), data is followed by:

```
<dens>ddd.dddd</dens><vb>vv.v</vb><i>ccc.c</i>
```

where

density sigma-t (kg/m^3) = ddd.dddd

battery voltage = vv.v

operating current (mA) = ccc.c

The rest of the data stream is as described above for uploaded data.

Setup for Deployment

1. Install new batteries or ensure the existing batteries have enough capacity to cover the intended deployment (see *Replacing Alkaline Batteries* in *Section 5: Routine Maintenance and Calibration*).
2. Program the 16plus V2 for the intended deployment using Seaterm232 (see *Section 3: Power and Communications Test* for connection information; see this section for setup/configuration, sampling modes, pump operation, and commands):
 - A. Ensure all data has been uploaded, and then send **InitLogging** to make the entire memory available for recording. If **InitLogging** is not sent, data will be stored after the last recorded sample.
 - B. Set the date and time (**DateTime=**).
 - C. Establish setup and (if applicable) autonomous sampling parameters.
If you will be using Seasave to acquire and view real-time data, you must set OutputFormat=0 (raw hexadecimal).
 - D. Send **GetCD** or **DS** to verify the setup.
 - E. If desired, use **StartDateTime=** and **StartLater** to establish delayed start date and time.
3. If you will be using Seaterm232 to view real-time data, click the Capture menu to save the data to a file. Enter the desired capture file name in the dialog box, and click Save.
4. If you will be using Seasave to acquire and view real-time data, verify that the configuration (.xmlcon or .con) file matches the instrument configuration. Sea-Bird supplies a configuration file to match the factory configuration and calibrations. If the instrument is recalibrated or the configuration is changed (such as by adding external sensors), the configuration file must be updated to reflect the current condition. See *Verifying Contents of Configuration (.xmlcon or .con) File*.

Note:

A new or recalibrated CTD ships with a configuration file that reflects the current configuration *as we know it*. The file is named with the instrument serial number, followed by a .xmlcon extension. For example, for a CTD with serial number 2375, Sea-Bird names the file *2375.xmlcon*. You may rename the file (but not the extension) if desired; this will not affect the results.

Deployment

CAUTION:

Do not use WD-40 or other petroleum-based lubricants, as they will damage the connectors.

1. Install a cable or dummy plug for each connector on the 16plus V2 sensor end cap:
 - A. Lightly lubricate the inside of the dummy plug/cable connector with silicone grease (DC-4 or equivalent).
 - B. **Standard Connector** - Install the plug/cable connector, aligning the raised bump on the side of the plug/cable connector with the large pin (pin 1 - ground) on the 16plus V2. Remove any trapped air by *burping* or gently squeezing the plug/connector near the top and moving your fingers toward the end cap. **OR**
MCBH Connector – Install the plug/cable connector, aligning the pins.
 - C. Place the locking sleeve over the plug/cable connector. Tighten the locking sleeve finger tight only. **Do not overtighten the locking sleeve and do not use a wrench or pliers.**

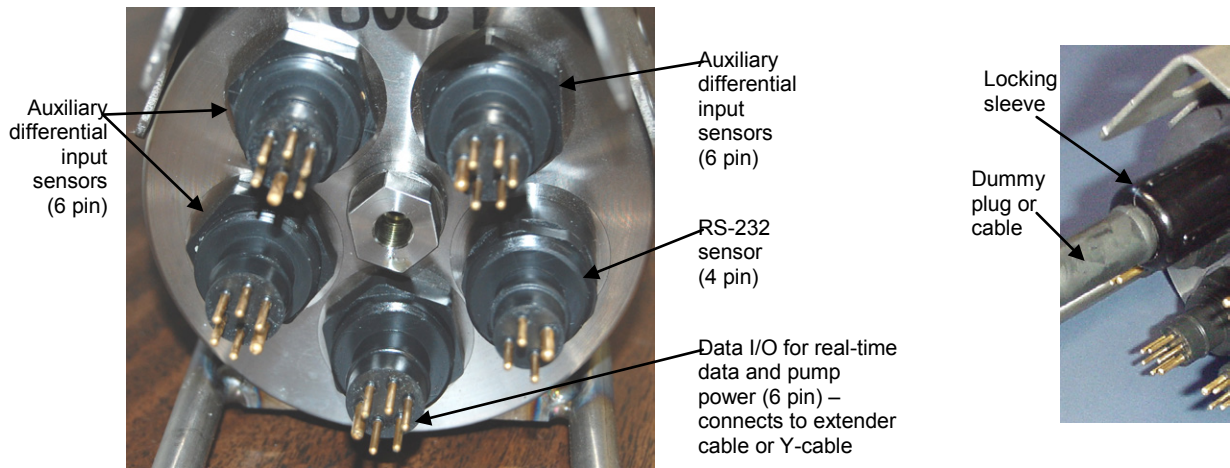

2. Connect the other end of the cables installed in Step 1 to the appropriate sensors.
3. Verify that the hardware and external fittings are secure.
4. As applicable, remove the plug(s) from the anti-foulant device cap(s), or remove the Tygon tubing (and associated barbed anti-foulant device caps) that was looped end-to-end around the conductivity cell for storage (see *Conductivity Cell Maintenance* in *Section 5: Routine Maintenance and Calibration*). Verify that the two plastic cups contain AF24173 Anti-Foulant Devices (see *Section 5: Routine Maintenance and Calibration* for Anti-Foulant Device replacement). If using the 16plus V2 with a pump, verify that the system plumbing is correctly installed (see *Configuration Options and Plumbing* in *Section 2: Description of SBE 16plus V2*).
5. For autonomous sampling: If not already done, send **StartNow** or send **StartDateTime=** and **StartLater**.

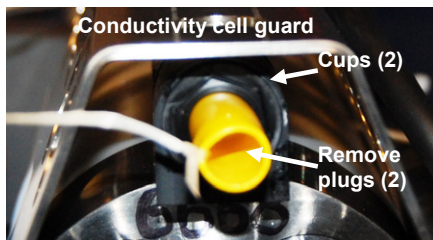

The SBE 16plus V2 is ready to go into the water.

Acquiring Real-Time Data with Seasave

Notes:

- Seasave and SBE Data Processing versions 7.20a introduced .xmlcon files (in XML format). Versions 7.20a and later allow you to open a .con or .xmlcon file, and to save it to a .con or .xmlcon file. Seasave and SBE Data Processing use the same file.
- A new or recalibrated CTD ships with a configuration file that reflects the current configuration *as we know it*. The file is named with the instrument serial number, followed by a .con extension. For example, for a CTD with serial number 2375, Sea-Bird names the file *2375.con*. You may rename the file (but not the extension) if desired; this will not affect the results.
- In the 16plus V2 setup commands, external voltage numbers 0, 1, 2, 3, 4, and 5 correspond to wiring of sensors to a voltage channel on the end cap (see *Dimensions and End Cap Connectors* in *Section 2: Description of SBE 16plus V2*). However, in the .xmlcon or .con file, voltage 0 is the first external voltage in the data stream, voltage 1 is the second, etc.

Verifying Contents of Configuration (.xmlcon or .con) File

Seasave, our real-time data acquisition and display program, requires a configuration file, which defines the CTD – auxiliary sensors integrated with the CTD, and channels, serial numbers, calibration dates, and coefficients for all the sensors (conductivity, temperature, and pressure as well as auxiliary sensors). Seasave (and our data processing software) uses the information in the configuration file to interpret and process the raw data. **If the configuration file does not match the actual instrument configuration, the software will be unable to interpret and process data correctly.**

1. Double click on Seasave.exe.
2. Click Configure Inputs. On the Instrument Configuration tab, click *Open*. In the dialog box, select the .xmlcon or .con file and click Open.

- The configuration information appears on the Instrument Configuration tab. Verify that the sensors match those on your 16plus V2, and that auxiliary sensors are assigned to the correct voltage channels. Click Modify to bring up a dialog box (shown below) to change the configuration and/or to view / modify calibration coefficients.

Configuration for the SBE 16plus V2 Se

Configuration file opened: 16plusv2.con

Pressure sensor type: Strain Gauge Data...

External voltage channels: 2

Serial RS-232C sensor: Temperature, SBE 38

Sample interval seconds: 10

NMEA position data added

Channel	Sensor	
1. Count	Temperature	New
2. Frequency	Conductivity	Open...
3. Count	Pressure, Strain Gauge	Save
4. A/D voltage 0	Oxygen, SBE 43	Save As...
5. A/D voltage 1	Fluorometer, Turner SCUFA	
6. Serial RS-232	Temperature, SBE 38	Select...
		Modify...

Report... Help... Exit Cancel

Channel/Sensor table reflects this choice (0, 1, 2, 3, 4, 5, or 6). Must agree with 16plus V2 setup for VoltN= (N=0, 1, 2, 3, 4, and 5); see reply from GetCD or DS. Voltage channel 0 in .xmlcon or .con file corresponds to first external voltage in data stream, voltage channel 1 to second, etc.

Interval between scans. Must agree with 16plus V2 setup (SampleInterval=); see reply from GetCD or DS.

Select if using with Interface Box connected to NMEA navigation device. Seasave adds current latitude, longitude, and universal time code to data header; appends NMEA data to every scan; and writes NMEA data to .nav file every time Ctrl F7 is pressed or Add to .nav File is clicked.

Internally mounted pressure sensor: strain gauge, Digiquartz with temperature compensation, or none. If no pressure sensor is selected, Data button accesses dialog box to input additional parameter needed to process data. Must agree with 16plus V2 setup (PType=); see reply from GetCD or DS. Selection applies only to internally mounted pressure sensor; if 16plus V2 has no internally mounted pressure but is interfacing with SBE 50 pressure sensor, select No pressure sensor here and then select SBE 50 in Serial RS-232C sensor field. Note: Digiquartz without temperature compensation is not applicable.

SBE 38 (secondary temperature), SBE 50 (pressure), SBE 63 (optical DO), WET Labs sensor (up to 3 channels), up to 2 GTDs (DO or nitrogen), or Optode. Must agree with 16plus V2 setup; see reply from GetCD or DS. Channel/Sensor table lists RS-232 sensors below voltage channels.

Shaded sensors cannot be removed or changed to another type of sensor. All others are optional.

New to create new .xmlcon or .con file for this CTD. Open to select different .xmlcon or .con file. Save or Save As to save current .xmlcon or .con file settings.

Click a (non-shaded) sensor and click Select to pick a different sensor for that channel. A dialog box with a list of sensors appears. Select sensors after number of voltage channels have been specified above.

Click a sensor and click Modify to change calibration coefficients for that sensor.

- Click Save or Save As to save any changes to the .xmlcon or .con file. Click Exit when done reviewing / modifying the configuration.

Acquiring Real-Time Data

Note:

The cable connected to the Data I/O, Pump, and External Power connector on the 16plus V2 end cap is dependent on whether the 16plus V2 is configured with a pump:

- When configured without a pump, an extender cable provides communications with the computer via the 4-pin connector.
- When configured with a pump, a Y-cable provides power to the pump via the 2-pin connector as well as communications with the computer via the 4-pin connector.

Instructions below are for an SBE 16plus V2 with a conventional single-core armored cable, used without a Sea-Bird Deck Unit. **If using the 16plus V2 with the SeaAT/Sealogger RS-232 and Navigation Interface Box, see the Interface Box manual.**

1. Wiring - Terminate the single-core armored cable with an RMG-4FS connector (16plus V2 with standard connectors) or MCIL-4FS (16plus V2 with optional wet-pluggable connectors). Wire the cable armor to pin 1 (large pin for 16plus V2 with standard connectors) and the inner conductor to pin 3 (opposite large pin) on the 16plus V2 data I/O - power connector (4-pin leg on Y-cable connected to Data I/O, Pump, and External Power bulkhead connector, or 4-pin connector on extender cable). On deck, wire:

Slip-ring lead	25-pin serial port	9-pin serial port
from armor	Pin 7	Pin 5
from inner conductor	Pin 3	Pin 2

Note:

The baud rate between the 16plus V2 and computer (defined in Configure Inputs, on the Serial Ports tab) must match the baud rate set in the 16plus V2 with **BaudRate=**.

2. Double click on **Seasave.exe**.
3. Perform any desired setup in the Configure Inputs, Configure Outputs, and Display menus. .
4. In the Real-Time Data menu, select *Start*. The dialog box looks like this:

Data Archiving Options:

- **Begin archiving data immediately** to store raw (frequencies, A/D counts, and/or voltages) real-time data as soon as Start button is clicked and communication is established.
- **Begin archiving data when 'Start Archiving' command is sent** to control when data begins to be written to file. This allows you to eliminate scans associated with deploying CTD from ship deck and soaking instrument near surface (alternatively, remove these scans later in SBE Data Processing). If you make this selection, when you click Start button and communication is established, a dialog box with Start Archiving button appears. Click this button when ready to begin saving scans to file, or select Start Archiving in Real-Time Data menu.
- **Do not archive data for this cast** to not save data to a file. Real-time data will still appear in displays.

Configuration Options: Currently selected instrument configuration (.xmlcon or .con) file is shown, containing information on number and type of sensors interfacing with 16plus V2, calibration coefficients, and inclusion of NMEA data with output from CTD. To modify input configuration (.xmlcon or .con file, serial ports, TCP/IP ports, and/or miscellaneous), click Configure Inputs. To modify outputs (serial data output, serial ports, shared file output, mark variables, TCP/IP output, TCP/IP ports, SBE 14 remote display, header form, and/or diagnostics), click Configure Outputs.

- **Timeout in seconds at startup:** Time allowed before first data scan is received from 16plus V2. Seasave will *time out* and stop attempting to acquire data if data is not received from 16plus V2 within this time period.
- **Timeout in seconds between scans:** Maximum **gap** allowed between scans after first data scan is received from 16plus V2. Seasave will *time out* and stop attempting to acquire data if data is not received from 16plus V2 within this time period (for example, if a shark bites cable and interrupts data acquisition, Seasave stops attempting to acquire data after this gap).

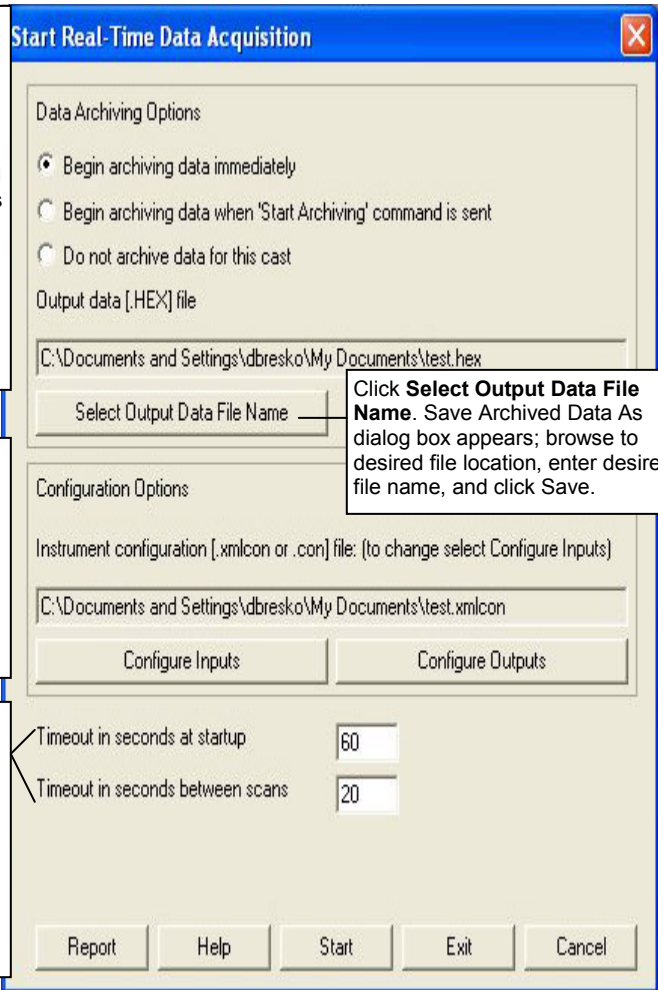

Click **Select Output Data File Name**. Save Archived Data As dialog box appears; browse to desired file location, enter desired file name, and click Save.

Notes:

- The 16plus V2 must be sampling autonomously to use Seasave for real-time data acquisition. Start sampling by sending **StartNow** or **StartLater** in Seaterm232 before starting acquisition in Seasave.
- To prevent problems in the use of the COM port, click Disconnect in the Communications menu in Seaterm232, and close Seaterm232 before starting real-time acquisition in Seasave.

5. In the Start Real-Time Data Acquisition dialog box, click *Start*.
 - A. If you selected *Begin archiving data immediately* or *Begin archiving data when 'Start Archiving' command is sent* above, and selected *Prompt for Header Information* in the Header Form setup (Configure Outputs), the Header Information dialog box appears. Fill in the desired header and click OK.
 - B. If you selected *NMEA position data added* in the .xmlcon or .con file, Seasave initializes NMEA communications.
 - C. If you selected *Check Scan Length* in the Options menu, Seasave checks the .xmlcon or .con file to verify that the scan length defined by the configuration file matches the 16plus V2 (i.e., number of sensors and inclusion of NMEA is as defined in the file). If a *Scan length error* appears, verify that:
 - You are using the correct .xmlcon or .con configuration file.
 - The configuration file has been updated as necessary if you added or deleted sensors, added or deleted NMEA, etc.
 - D. Seasave sends a message: *Waiting for data . . .* Seasave will *time out* if data is not received within *Timeout in seconds at startup*.
 - E. The data then starts appearing in the screen displays.
6. To stop real-time data acquisition: In the Real-Time Data menu, select *Stop*. Close Seasave.
7. In **Seaterm232**, stop logging by sending **Stop**.

Recovery**WARNING!**

If the 16plus V2 stops working while underwater, is unresponsive to commands, or shows other signs of flooding or damage, carefully secure it away from people until you have determined that abnormal internal pressure does not exist or has been relieved. Pressure housings may flood under pressure due to dirty or damaged o-rings, or other failed seals. When a sealed pressure housing floods at great depths and is subsequently raised to the surface, water may be trapped at the pressure at which it entered the housing, presenting a danger if the housing is opened before relieving the internal pressure. Instances of such flooding are rare. However, a housing that floods at 5000 meters depth holds an internal pressure of more than 7000 psia, and has the potential to eject the end cap with lethal force. A housing that floods at 50 meters holds an internal pressure of more than 85 psia; this force could still cause injury. If you suspect the 16plus V2 is flooded, point the 16plus V2 in a safe direction away from people, and loosen 1 end cap bulkhead connector very slowly, at least 1 turn. This opens an o-ring seal under the connector. Look for signs of internal pressure (hissing or water leak). If internal pressure is detected, let it bleed off slowly past the connector o-ring. Then, you can safely remove the end cap.

Physical Handling

1. Rinse the instrument and conductivity cell with fresh water. (See *Section 5: Routine Maintenance and Calibration* for cell cleaning and storage.)
2. Reinsert the protective plugs in the anti-foulant device cups.
3. If the batteries are exhausted, new batteries must be installed before the data can be extracted. Stored data will not be lost as a result of exhaustion or removal of batteries. (See *Section 5: Routine Maintenance and Calibration* for replacement of batteries.)
4. If immediate redeployment is not required, it is best to leave the 16plus V2 with batteries in place and in a quiescent state (**QS**). Because the quiescent current required is only 20 microamps, the batteries can be left in place without significant loss of capacity. If the 16plus V2 is to be stored for a long time, **replace the batteries yearly to prevent battery leakage** (which could damage the 16plus V2).

Uploading Data

Note:

Data may be uploaded during deployment or after recovery. If uploading after recovery, connect the I/O cable as described in *Section 3: Power and Communications Test*.

1. Double click on **SeatermV2.exe**. The main screen appears.
2. In the Instruments menu, select *SBE 16plus V2 RS232*. **Seaterm232** opens.
3. Seaterm232 will try to automatically connect to the 16plus V2. As it connects, it sends **GetHD** and displays the response. Seaterm232 also fills the Send Commands window with the correct list of commands for your 16plus V2. **If there is no communication:**
 - A. In the Communications menu, select *Configure*. The Serial Port Configuration dialog box appears. Select the Comm port and baud rate for communication, and click OK.
 - B. In the Communications menu, select *Connect* (if *Connect* is grayed out, select *Disconnect and reconnect*).
 - C. Check cabling between the computer and 16plus V2.
 - D. If there is still no communication, repeat Step A with a different baud rate and/or comm port, and try to connect again. Note that the factory-set baud rate is documented on the Configuration Sheet.

Note:

You may need to send **Stop** several times to get the 16plus V2 to respond.

4. Command the 16plus V2 to stop logging by pressing the Enter key, typing **Stop**, and pressing the Enter key again.
5. Display 16plus V2 status information by typing **DS** and pressing the Enter key. The display looks like this:

```
SBE 16plus V 2.5 SERIAL NO. 6001 12 May 2012 14:11:48
vbatt = 10.3, vlith = 8.5, ioper = 62.5 ma, ipump = 21.6 ma,
iext01 = 76.2 ma
status = not logging
samples = 162, free = 3462898
sample interval = 15 seconds, number of measurements per sample = 1
pump = run pump during sample, delay before sampling = 2.0 seconds,
delay after sampling = 0.0 seconds
transmit real-time = yes
battery cutoff = 7.5 volts
pressure sensor = strain gauge, range = 1000.0
SBE 38 = no, SBE 50 = no, WETLABS = no, OPTODE = no, SBE 63 = no,
Gas Tension Device = no
Ext Volt 0 = yes, Ext Volt 1 = yes
Ext Volt 2 = no, Ext Volt 3 = no
Ext Volt 4 = no, Ext Volt 5 = no
echo characters = yes
output format = converted decimal
output salinity = no, output sound velocity = no
serial sync mode disabled
```

Verify that the status shows **status = not logging**.

6. Click Upload to upload stored data. Seaterm232 responds as follows:
 - A. Seaterm232 sends **GetSD** and displays the response. **GetSD** provides information on the instrument status, and number of samples in memory.
 - B. Seaterm232 sends **DH** and displays the response. **DH** provides information on the headers in memory.
 - C. In the Save As dialog box, enter the desired upload file name and click OK. The upload file has a .XML extension.
 - D. An Upload Data dialog box appears:

Note:
 If binary upload is selected, Seaterm232 uploads the data in binary and then converts it to ASCII text, resulting in a data file that is identical to one uploaded in ASCII text.

Select number of bytes uploaded in each block. Seaterm232 uploads data in blocks, and calculates a checksum at end of each block. If block fails checksum verification, Seaterm232 tries to upload block of data again, cutting block size in half.

Defines data upload type and range:

- All data as a single file – All data is uploaded into 1 file.
- By scan number range – Enter beginning scan (sample) number and total number of scans. All data within range is uploaded into 1 file.
- By address range – Enter beginning byte number and total number of bytes. Note that first byte in memory is byte 0. All data within range is uploaded into 1 file.

To change upload file name selected in Step C above, click Browse to navigate to desired upload file path and name. Upload file has a .xml extension. After Seaterm232 uploads data into .xml file, it automatically converts .xml file to .hex file (same file name, different extension), which is compatible with Seasave and SBE Data Processing.

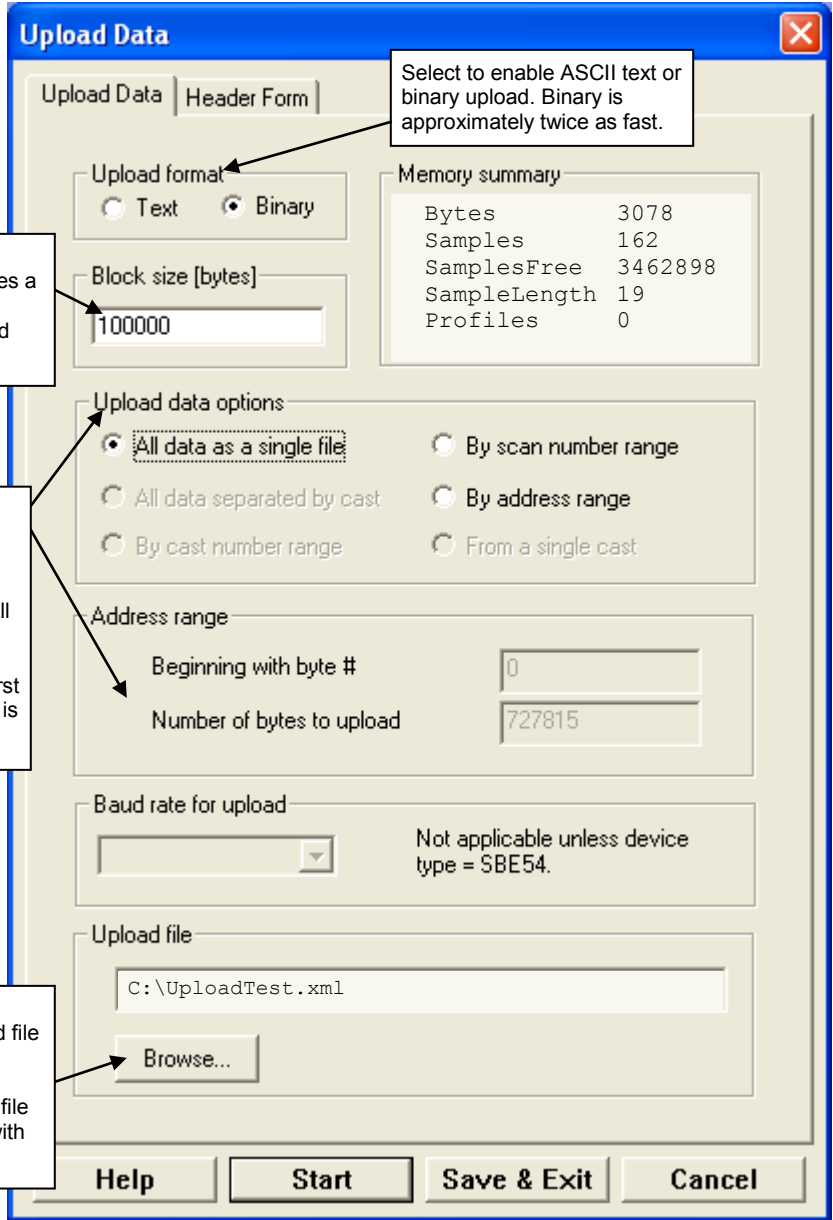

Make the desired selections.

7. Click the Header Form tab to customize the header:

Defines header information included with uploaded data:

- Prompt for header information – As data is uploaded, user is prompted to fill out user-defined header form.
- Include default header form in upload file – User-defined default header form included in upload file. User is not prompted to add any information when data is uploaded.
- Don't include default header form in upload file – Header information not included in upload file.

The entries are free form, 0 to 12 lines long. This dialog box establishes:

- the header prompts that appear for the user to fill in when uploading data, if *Prompt for header information* was selected
- the header included with the uploaded data, if *Include default header form in upload file* was selected

Enter the desired header/header prompts.

8. Click Start; the Status bar at the bottom of the window displays the upload progress:

- A. Seaterm232 sends **GetHD** (get hardware data), **GetSD** (get status data), **GetCD** (get configuration data), **GetCC** (get calibration coefficients), and **GetEC** (get event counter), and writes the responses to the upload file. These commands provide information regarding the number of samples in memory, header numbers, calibration coefficients, etc.
- B. **If you selected *Prompt for header information* in the Upload Data dialog box** – a dialog box with the header form appears. Enter the desired header information, and click OK. Seaterm232 writes the header information to the upload file.
- C. Seaterm232 sends the data upload command, based on your selection of upload range in the Upload Data dialog box, writes the data to the upload .xml file, and then creates the .hex file from the .xml file. The .hex file contains the data in raw hexadecimal, for compatibility with Seasave and SBE Data Processing.
- D. When the data has been uploaded, Seaterm232 shows the S> prompt (if **OutputExecutedTag=N**).

Note:

The commands and responses automatically sent by Seaterm232 during the upload do not appear in the Command/Data Echo Area.

Note:

To prepare for re-deployment:

1. After all data has been uploaded, send **InitLogging**. If this command is not sent and sampling is started, new data will be stored after the last recorded sample, preventing use of the entire memory capacity.
2. Send **QS** to put the 16plus V2 in quiescent (sleep) state until ready to redeploy. The quiescent current is only 20 microamps, so the batteries can be left in place without significant loss of capacity.

9. Ensure all data has been uploaded by reviewing and processing the data:
 - A. Use **Seasave** to display and plot the *raw* hexadecimal data in engineering units (see *Verifying Contents of Configuration (.xmlcon or .con) File* and Seasave manual / Help files).
 - B. Use **SBE Data Processing** to process and plot the data (see *Processing Data Using SBE Data Processing* and SBE Data Processing manual / Help files).

Processing Data Using SBE Data Processing

Notes:

- Seasave and SBE Data Processing versions 7.20a introduced .xmlcon files (in XML format). Versions 7.20a and later allow you to open a .con or .xmlcon file, and to save it to a .con or .xmlcon file. Seasave and SBE Data Processing use the same file.
- A new or recalibrated CTD ships with a configuration file that reflects the current configuration *as we know it*. The file is named with the instrument serial number, followed by a .con extension. For example, for a CTD with serial number 2375, Sea-Bird names the file 2375.con. You may rename the file (but not the extension) if desired; this will not affect the results.
- In the 16plus V2 setup commands, external voltage numbers 0, 1, 2, 3, 4, and 5 correspond to wiring of sensors to a voltage channel on the end cap (see *Dimensions and End Cap Connectors in Section 2: Description of SBE 16plus V2*). However, in the .xmlcon or .con file, voltage 0 is the first external voltage in the data stream, voltage 1 is the second, etc.

- Convert the .hex (raw data) file (uploaded from 16plus V2 memory or real-time file from Seasave) to a .cnv (engineering units) file in SBE Data Processing's Data Conversion module.
- Once the data is converted: perform further processing (filter, remove bad data, etc.), calculate derived variables, and plot data using SBE Data Processing's other modules.

Verifying Contents of Configuration (.xmlcon or .con) File

To convert the .hex (raw data) file, you need a .xmlcon or .con configuration file, which defines the instrument – integrated sensors, and channels, serial numbers, and calibration dates and coefficients for all sensors (conductivity, temperature, and pressure as well as auxiliary sensors). SBE Data Processing uses the configuration file information to interpret and process the raw data. **If the configuration file does not match the actual instrument configuration, the software will be unable to interpret and process the data correctly.**

To view or modify the .xmlcon or .con file:

- Double click on SBEDataProc.exe.
- In the Configure menu, select *SBE 16plus V2 Seacat CTD*. The configuration dialog box appears; click Open.
- In the Open dialog box, select the .xmlcon or .con file and click Open. Verify that the sensors match those on your 16plus V2, auxiliary sensors are assigned to the correct voltage channels, and calibration coefficients for all sensors are up-to-date.

Internally mounted pressure sensor: strain gauge, Digiquartz with temperature compensation, or none. If *no pressure sensor* is selected, Data button accesses dialog box to input additional parameter needed to process data. Must agree with 16plus V2 setup (**PType=**); see reply from **GetCD** or **DS**. Selection applies only to internally mounted pressure sensor; if 16plus V2 has no internally mounted pressure but is interfacing with SBE 50 pressure sensor, select *No pressure sensor* here and then select *SBE 50* in Serial RS-232C sensor field. Note: Digiquartz without temperature compensation is not applicable.

Channel/Sensor table reflects this choice (0, 1, 2, 3, 4, 5, or 6). Must agree with 16plus V2 setup for **VoltN=** (N=0, 1, 2, 3, 4, and 5); see reply from **GetCD** or **DS**. Voltage channel 0 in .xmlcon or .con file corresponds to first external voltage in data stream, voltage channel 1 to second, etc.

Interval between scans. Must agree with 16plus V2 setup (**SampleInterval=**); see reply from **GetCD** or **DS**.

Select if using with Interface Box connected to NMEA navigation device. Seasave adds current latitude, longitude, and universal time code to data header; appends NMEA data to every scan; and writes NMEA data to .nav file every time Ctrl F7 is pressed or Add to .nav File is clicked.

Configuration for the SBE 16plus V2

Configuration file opened: 16plus V2

Pressure sensor type: Strain Gauge [Data...]

External voltage channels: 2

Serial RS-232C sensor: Temperature, SBE 38

Sample interval seconds: 10

NMEA position data added

Channel	Sensor
1. Count	Temperature
2. Frequency	Conductivity
3. Count	Pressure, Strain Gauge
4. A/D voltage 0	Oxygen, SBE 43
5. A/D voltage 1	Fluorometer, Turner SCUFA
6. Serial RS-232	Temperature, SBE 38

[New] [Open...] [Save] [Save As...]

[Select...] [Modify]

[Report...] [Help...] [Exit] [Cancel]

SBE 38 (secondary temperature), SBE 50 (pressure), SBE 63 (optical DO), WET Labs sensor (up to 3 channels), up to 2 GTDs (dissolved oxygen or nitrogen), or Optode. Must agree with 16plus V2 setup; see reply from **GetCD** or **DS**. Channel/Sensor table lists RS-232 sensors below voltage channels.

Shaded sensors cannot be removed or changed to another type of sensor. All others are optional.

New to create new .xmlcon or .con file for this CTD. Open to select different .xmlcon or .con file. Save or Save As to save current .xmlcon or .con file settings.

Click a (non-shaded) sensor and click **Select** to pick a different sensor for that channel. A dialog box with a list of sensors appears. Select sensors after number of voltage channels have been specified above.

Click a sensor and click **Modify** to change calibration coefficients for that sensor.

- Click *Save* or *Save As* to save any changes to the .xmlcon or .con file. Click *Exit* when done reviewing / modifying the configuration.

Editing Raw Data File

Sometimes users want to edit the raw .hex data file before beginning processing, to remove data at the beginning of the file corresponding to instrument *soak* time, to remove blocks of bad data, to edit the header, or to add explanatory notes about the cast. **Editing the raw .hex file can corrupt the data, making it impossible to perform further processing using Sea-Bird software.** Sea-Bird strongly recommends that you first convert the data to a .cnv file (using the Data Conversion module in SBE Data Processing), and then use other SBE Data Processing modules to edit the .cnv file as desired.

Note:

Although we provide this technique for editing a raw .hex file, **Sea-Bird's strong recommendation, as described above, is to always convert the raw data file and then edit the converted file.**

The procedure for editing a .hex data file described below has been found to work correctly on computers running Windows 98, 2000, and NT. **If the editing is not performed using this technique, SBE Data Processing may reject the edited data file and give you an error message.**

1. **Make a back-up copy of your .hex data file before you begin.**
2. Run **WordPad**.
3. In the File menu, select Open. The Open dialog box appears. For *Files of type*, select *All Documents (*.*)*. Browse to the desired .hex data file and click Open.
4. Edit the file as desired, **inserting any new header lines after the System Upload Time line**. Note that all header lines must begin with an asterisk (*), and *END* indicates the end of the header. An example is shown below (for an SBE 21), with the added lines in bold:

```
* Sea-Bird SBE 21 Data File:
* FileName = C:\Odis\SAT2-ODIS\oct14-19\oct15_99.hex
* Software Version Seasave Win32 v1.10
* Temperature SN = 2366
* Conductivity SN = 2366
* System UpLoad Time = Oct 15 1999 10:57:19
* Testing adding header lines
* Must start with an asterisk
* Place anywhere between System Upload Time & END of header
* NMEA Latitude = 30 59.70 N
* NMEA Longitude = 081 37.93 W
* NMEA UTC (Time) = Oct 15 1999 10:57:19
* Store Lat/Lon Data = Append to Every Scan and Append to .NAV
File When <Ctrl F7> is Pressed
** Ship:          Sea-Bird
** Cruise:        Sea-Bird Header Test
** Station:
** Latitude:
** Longitude:
*END*
```
5. In the File menu, select Save (**not Save As**). If you are running Windows 2000, the following message displays:
You are about to save the document in a Text-Only format, which will remove all formatting. Are you sure you want to do this?
Ignore the message and click *Yes*.
6. In the File menu, select Exit.

Section 5: Routine Maintenance and Calibration

This section reviews:

- corrosion precautions
- connector mating and maintenance
- battery replacement
- conductivity cell storage and cleaning
- pressure sensor maintenance
- pump maintenance
- AF24173 Anti-Foulant Device replacement
- sensor calibration

The accuracy of the SBE 16plus V2 is sustained by the care and calibration of the sensors and by establishing proper handling practices.

Corrosion Precautions

Rinse the SBE 16plus V2 with fresh water after use and prior to storage.

For both the plastic and titanium housing, all exposed metal is titanium (the plastic housing has a titanium end cap). No corrosion precautions are required, but direct electrical connection of the titanium to dissimilar metal hardware should be avoided.

Connector Mating and Maintenance

Note:

See *Application Note 57: Connector Care and Cable Installation*.

Clean and inspect connectors, cables, and dummy plugs before every deployment and as part of your yearly equipment maintenance. Inspect connectors that are unmated for signs of corrosion product around the pins, and for cuts, nicks or other flaws that may compromise the seal.

When remating:

CAUTION:

Do not use WD-40 or other petroleum-based lubricants, as they will damage the connectors.

1. Lightly lubricate the inside of the dummy plug/cable connector with silicone grease (DC-4 or equivalent).
2. **Standard Connector** - Install the plug/cable connector, aligning the raised bump on the side of the plug/cable connector with the large pin (pin 1 - ground) on the 16plusV2. Remove any trapped air by *burping* or gently squeezing the plug/connector near the top and moving your fingers toward the end cap. **OR**
MCBH Connector – Install the plug/cable connector, aligning the pins.
3. Place the locking sleeve over the plug/cable connector. Tighten the locking sleeve finger tight only. **Do not overtighten the locking sleeve and do not use a wrench or pliers.**

Verify that a cable or dummy plug is installed for each connector on the system before deployment.

Replacing Alkaline Batteries



Alkaline D-cell
(MN1300, LR20)

The SBE 16plus V2 uses alkaline D-cells (Duracell MN1300, LR20), dropped into the battery compartment.

Leave the batteries in place when storing the SBE 16plus V2 to prevent depletion of the back-up lithium batteries by the real-time clock. Even *exhausted* main batteries will power the clock (20 microamps) almost indefinitely. If the 16plus V2 is to be stored for long periods, **replace the batteries yearly to prevent battery leakage** (which could damage the 16plus V2).

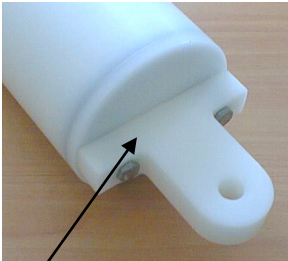

Unthread cap by rotating counter-clockwise

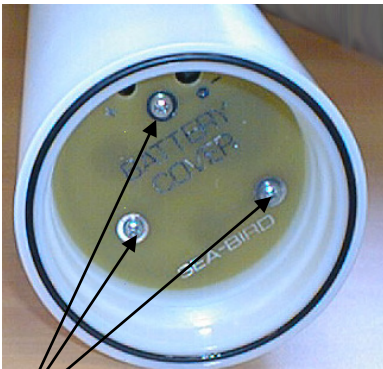

Remove Phillips-head screws and washers

1. Remove the battery end cap (end cap without connectors):
 - A. Wipe the outside of the end cap and housing dry, being careful to remove any water at the seam between them.
 - B. Unthread the end cap by rotating counter-clockwise (use a wrench on the white plastic bar if necessary).
 - C. Remove any water from the O-ring mating surfaces inside the housing with a lint-free cloth or tissue.
 - D. Put the end cap aside, being careful to protect the O-ring from damage or contamination.
2. Remove the battery cover plate from the housing:
 - A. Remove the three Phillips-head screws and washers from the battery cover plate inside the housing.
 - B. The battery cover plate will pop out. Put it aside.
3. Turn the 16plus V2 over and remove the batteries.
4. Install the new batteries, with the + terminals against the flat battery contacts and the - terminals against the spring contacts.
5. Reinstall the battery cover plate in the housing:
 - A. Align the battery cover plate with the housing. The posts inside the housing are not placed symmetrically, so the cover plate fits into the housing only one way. Looking at the cover plate, note that one screw hole is closer to the edge than the others, corresponding to the post that is closest to the housing.
 - B. Reinstall the three Phillips-head screws and washers, while pushing hard on the battery cover plate to depress the spring contacts at the bottom of the battery compartment. **The screws must be fully tightened, or battery power to the circuitry will be intermittent.**
6. Check the battery voltage at BAT + and BAT - on the battery cover plate. It should be approximately 13.5 volts.
7. Reinstall the battery end cap:
 - A. Remove any water from the O-rings and mating surfaces with a lint-free cloth or tissue. Inspect the O-rings and mating surfaces for dirt, nicks, and cuts. Clean or replace as necessary. Apply a light coat of o-ring lubricant (Parker Super O Lube) to O-rings and mating surfaces.
 - B. Carefully fit the end cap into the housing and rethread the end cap into place. Use a wrench on the white plastic bar to ensure the end cap is tightly secured.

Conductivity Cell Maintenance

CAUTIONS:

- **Do not put a brush or any object inside the conductivity cell to dry it or clean it.** Touching and bending the electrodes can change the calibration. Large bends and movement of the electrodes can damage the cell.
- **Do not store the 16plus V2 with water in the conductivity cell.** Freezing temperatures (for example, in Arctic environments or during air shipment) can break the cell if it is full of water.

The SBE 16plus V2's conductivity cell is shipped dry to prevent freezing in shipping. Refer to *Application Note 2D: Instructions for Care and Cleaning of Conductivity Cells for conductivity cell cleaning procedures and cleaning materials.*

- The Active Use (after each cast) section of the application note is not applicable to the 16plus V2, which is intended for use as a moored instrument.

The 16plus V2 is shipped with a kit for cell filling and storage. The kit includes a syringe and tubing assembly, and two anti-foulant device caps with hose barbs. The tubing cannot attach to an anti-foulant device cap that is not barbed.

- If your 16plus V2 does not include a pump - the installed anti-foulant device caps at both ends of the conductivity cell are not barbed.
- If your 16plus V2 includes a pump - the installed anti-foulant device cap at the pump end of the cell is barbed (for connection to the Tygon tubing); the installed anti-foulant device cap at the intake end of the cell is not barbed.

Unscrew cap, and replace with barbed cap for cleaning and storage

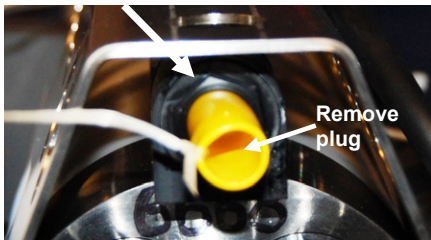

Cleaning and storage instructions require use of the syringe and tubing assembly at the intake end of the cell (requiring one barbed cap), and looping Tygon tubing from end to end of the cell (requiring two barbed caps). Remove the installed anti-foulant device cap(s) and replace them with the anti-foulant device cap(s) with hose barbs **for cleaning and storage only**. Remember to reinstall the original anti-foulant device cap(s) before deployment (non-barbed caps at both ends if the 16plus V2 does not include a pump; non-barbed cap at the intake end if the 16plus V2 does include a pump). **Deploying a 16plus V2 with barbed anti-foulant device cap(s) in place of the installed caps is likely to produce undesirable results in your data.**

See *Replacing Anti-Foulant Devices* for safety precautions when handling the AF24173 Anti-Foulant Devices.

Internally Mounted Pressure Sensor (optional) Maintenance

CAUTION:

Do not put a brush or any object in the pressure port. Doing so may damage or break the pressure sensor.

Pressure sensor maintenance varies, depending on the type of pressure sensor in your SBE 16plus V2.

Strain Gauge Pressure Sensor

Periodically (approximately once a year) inspect the pressure port for particles and debris. Rinse the pressure port with warm, de-ionized water to remove any particles, debris, etc.

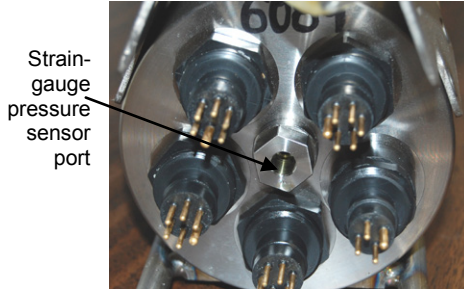

Quartz Pressure Sensor



Nylon pressure capillary fitting for 16plus V2 with Quartz pressure sensor

At the factory, the pressure sensor and pressure port were filled with a silicon oil, and a nylon pressure capillary fitting – which includes a pressure port fitting and an external capillary tube – were used to retain the oil. The oil transmits hydrostatic pressure via internal, stainless steel, capillary tubing to the pressure sensor inside the instrument, and prevents corrosion that might occur if the sensor diaphragm was exposed to water. The internal tubing and nylon capillary fitting are vacuum back-filled at the factory.

Because of the viscosity of the silicone oil and capillary action, the silicone oil does not run out of the external capillary tube. However, due to temperature and pressure cycling over long periods, it is normal for some oil to slowly leak out of the external capillary tube. **When the oil is not visible or is receding inside the translucent tube, or if the fitting has been damaged, refill the oil** using the supplied pressure sensor oil refill kit. See *Application Note 12-1: Pressure Port Oil Refill Procedure & Nylon Capillary Fitting Replacement*.

Pump (optional) Maintenance

See *Application Note 75: Maintenance of SBE 5T, 5P, and 5M Pumps*.

Replacing Anti-Foulant Devices (SBE 16plus, SBE 19plus)



AF24173
Anti-Foulant
Device

The SBE 16plus and 19plus (moored option) have an anti-foulant device cup and cap on each end of the conductivity cell. A new SBE 16plus (or moored option 19plus) is shipped with an Anti-Foulant Device and a protective plug pre-installed in each cup.

Wearing rubber or latex gloves, follow this procedure to replace each Anti-Foulant Device (two):

1. Remove the protective plug;
2. Unscrew the cap with a $\frac{5}{8}$ -inch socket wrench;
3. Remove the old Anti-Foulant Device. If the old Anti-Foulant Device is difficult to remove:
 - Use needle-nose pliers and carefully break up material;
 - If necessary, remove the conductivity cell guard to provide easier access;
4. Place the new Anti-Foulant Device in the cup;
5. Rethread the cap onto the cup. Do not over tighten;
6. Replace the protective plug if not ready to redeploy.

WARNING!

AF24173 Anti-Foulant Devices contain bis(tributyltin) oxide. Handle the devices only with rubber or latex gloves. Wear eye protection. Wash with soap and water after handling.

Read precautionary information on product label (see Appendix V) before proceeding.

It is a violation of US Federal Law to use this product in a manner inconsistent with its labeling.

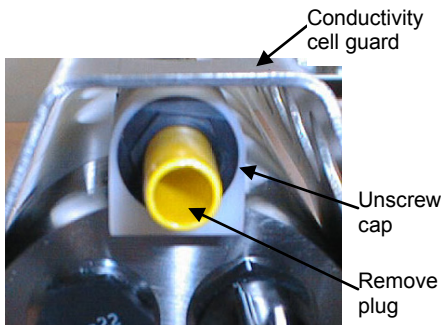

CAUTION:

One of the anti-foulant device cups is attached to the guard and connected to the conductivity cell. **Removing the guard without disconnecting the cup from the guard will break the cell.** If the guard must be removed:

1. Remove the two screws connecting the anti-foulant device cup to the guard;
2. Remove the four Phillips-head screws connecting the guard to the housing and sensor end cap;
3. Gently lift the guard away.

Sensor Calibration

Note

After recalibration, Sea-Bird enters the new calibration coefficients in the 16*plus* V2 EEPROM, and ships the instrument back to the user with Calibration Certificates showing the new coefficients. We also ship a new instrument configuration (.con) file, which includes the new coefficients.

Sea-Bird sensors are calibrated by subjecting them to known physical conditions and measuring the sensor responses. Coefficients are then computed, which may be used with appropriate algorithms to obtain engineering units. The conductivity, temperature, and (optional) internally mounted pressure sensor on the SBE 16*plus* V2 are supplied fully calibrated, with coefficients stored in EEPROM in the 16*plus* V2 and printed on their respective Calibration Certificates.

We recommend that the SBE 16*plus* V2 be returned to Sea-Bird for calibration.

Conductivity Sensor

The conductivity sensor incorporates a fixed precision resistor in parallel with the cell. When the cell is dry and in air, the sensor's electrical circuitry outputs a frequency representative of the fixed resistor. This frequency is recorded on the Calibration Certificate and should remain stable (within 1 Hz) over time.

The primary mechanism for calibration drift in conductivity sensors is the fouling of the cell by chemical or biological deposits. Fouling changes the cell geometry, resulting in a shift in cell constant.

Accordingly, the most important determinant of long-term sensor accuracy is the cleanliness of the cell. We recommend that the conductivity sensors be calibrated before and after deployment, but particularly when the cell has been exposed to contamination by oil slicks or biological material.

Temperature Sensor

The primary source of temperature sensor calibration drift is the aging of the thermistor element. Sensor drift will usually be a few thousandths of a degree during the first year, and less in subsequent intervals. Sensor drift is not substantially dependent upon the environmental conditions of use, and — unlike platinum or copper elements — the thermistor is insensitive to shock.

Internally Mounted Pressure Sensor

The SBE 16plus V2 is available with an internally mounted strain-gauge or Quartz pressure sensor. These sensors are capable of meeting the 16plus V2 error specification with some allowance for aging and ambient-temperature induced drift.

Strain-gauge pressure sensor port

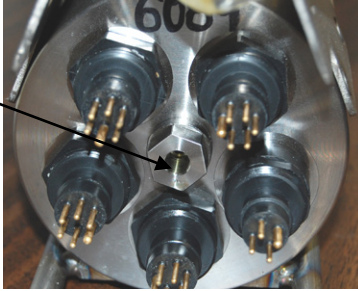

Pressure sensors show most of their error as a linear offset from zero.

A technique is provided below for making small corrections to the pressure sensor calibration using the *offset* (**POffset=**) calibration coefficient term by comparing SBE 16plus V2 pressure output to readings from a barometer.

Allow the SBE 16plus V2 to equilibrate in a reasonably constant temperature environment for at least 5 hours before starting. Pressure sensors exhibit a transient change in their output in response to changes in their environmental temperature. Sea-Bird instruments are constructed to minimize this by thermally decoupling the sensor from the body of the instrument. However, there is still some residual effect; allowing the 16plus V2 to equilibrate before starting will provide the most accurate calibration correction.

Note:

The internally mounted pressure sensor is an absolute sensor, so its **raw** output includes the effect of atmospheric pressure (14.7 psi). As shown on the Calibration Sheet, Sea-Bird's calibration (and resulting calibration coefficients) is in terms of psia. However, when outputting pressure in **engineering units**, the 16plus V2 outputs pressure relative to the ocean surface (i.e., at the surface the output pressure is 0 decibars).

The 16plus V2 uses the following equation to convert psia to decibars:
 pressure (db) =
 [pressure (psia) - 14.7] * 0.689476

1. Place the 16plus V2 in the orientation it will have when deployed.
2. In Seaterm232:
 - A. Set the pressure offset to 0.0 (**POffset=0**).
 - B. Send **TP** to measure the 16plus V2 pressure 100 times and transmit converted data in engineering units (decibars).
3. Compare the 16plus V2 output to the reading from a good barometer at the same elevation as the 16plus V2 pressure sensor.
 Calculate *offset* = barometer reading – 16plus V2 reading
4. Enter the calculated offset (positive or negative) in two places:
 - In the 16plus V2 EEPROM, using **POffset=** in Seaterm232, **and**
 - In the configuration (.xmlcon or .con) file, using Seasave or SBE Data Processing.

Offset Correction Example

Absolute pressure measured by a barometer is 1010.50 mbar. Pressure displayed from 16plus V2 is -2.5 dbars.

Convert barometer reading to dbars using the relationship: mbar * 0.01 = dbar

Barometer reading = 1010.50 mbar * 0.01 = 10.1050 dbar

The 16plus V2's internal calculations and our processing software output gage pressure, using an assumed value of 14.7 psi for atmospheric pressure. Convert 16plus V2 reading from gage to absolute by adding 14.7 psia to the 16plus V2 output:

$-2.5 \text{ dbars} + (14.7 \text{ psi} * 0.689476 \text{ dbar/psia}) = -2.5 + 10.13 = 7.635 \text{ dbars}$

Offset = 10.1050 – 7.635 = + 2.47 dbars

Enter offset in 16plus V2 and in .xmlcon or .con file.

For demanding applications, or where the sensor's air ambient pressure response has changed significantly, calibration using a dead-weight generator is recommended. The end cap's $\frac{7}{16}$ -20 straight thread permits mechanical connection to the pressure source. Use a fitting that has an O-ring tapered seal, such as Swagelok-200-1-4ST, which conforms to MS16142 boss.

Section 6: Troubleshooting

This section reviews common problems in operating the SBE 16plus V2, and provides the most common causes and solutions.

Problem 1: Unable to Communicate with SBE 16plus V2

If **OutputExecutedTag=N**, the S> prompt indicates that communications between the 16plus V2 and computer have been established. Before proceeding with troubleshooting, attempt to establish communications again by clicking *Connect* in the Communications menu in Seaterm232 or pressing the Enter key several times.

Cause/Solution 1: The I/O cable connection may be loose. Check the cabling between the 16plus V2 and computer for a loose connection.

Cause/Solution 2: The instrument communication settings may not have been entered correctly in the terminal program. Verify the settings in the Serial Port Configuration dialog box (Communications menu -> *Configure*). The settings should match those on the instrument Configuration Sheet.

Cause/Solution 3: The I/O cable may not be the correct one. The I/O cable supplied with the 16plus V2 permits connection to standard 9-pin RS-232 interfaces. See *Dimensions and End Cap Connectors* in Section 2: *Description of SBE 16plus V2* for cable pinouts.

Problem 2: No Data Recorded

Cause/Solution 1: The memory may be full; once the memory is full, no further data is recorded. Verify that the memory is not full using **GetSD** or **DS** (*free = 0* or *1* if memory is full). Sea-Bird recommends that you upload all previous data before beginning another deployment. Once the data is uploaded, send **InitLogging** to reset the memory. After the memory is reset, **GetSD** or **DS** will show *samples = 0*.

Problem 3: Unable to View Data in Seasave (Real-Time Data Acquisition program)

Note:

If *Check scan length* is enabled in Seasave's Options menu, Seasave checks the data scan length against the expected length (based on the configuration file setup), and provides a warning that there is an error. Sea-Bird recommends using this setting.

Cause/Solution 1: If the scan length does not match the selected .xmlcon or .con configuration file (for example, the configuration file indicates that there are four external voltage sensors integrated with the CTD, but you only enabled three external voltage sensors in the instrument setup [**Volt0=**, **Volt1=**, etc.]), **Seasave continues with real-time data acquisition (saving the raw data to a file for later processing), but does not show or plot data in the Seasave displays.** The data quality is not affected; you can correct the configuration file error in SBE Data Processing (post-processing), and process the data as required. Verify that the settings in the configuration file match the current CTD configuration - number and type of auxiliary sensors, sensors assigned to correct channels, NMEA selected if applicable.

Problem 4: Scan Length Error in SBE Data Processing or Seasave

Note:

To view the Diagnostics file in SBE Data Processing, select *Diagnostics* in Data Conversion's Options menu. In the Diagnostics dialog box, click on *Display Log File*.

Cause/Solution 1: If the scan length in the data file does not match the selected .xmlcon or .con configuration file (for example, the configuration file indicates that there are four external voltage sensors integrated with the CTD, but you only enabled three external voltage sensors in the instrument setup [**Volt0=**, **Volt1=**, etc.]), Seasave and/or SBE Data Processing's Data Conversion module will not process the data. If you look in the Diagnostics file in SBE Data Processing, you will see a *scan length error*. Check the configuration file against the header in the data file, and correct the configuration file as required.

Problem 5: Nonsense or Unreasonable Data

The symptom of this problem is a data file that contains nonsense values (for example, 9999.999) or unreasonable values (for example, values that are outside the expected range of the data).

Cause/Solution 1: A data file with nonsense values may be caused by incorrect instrument configuration:

- Bad data may be caused by incorrect setup in the 16plus V2. Send **GetCD** or **DS** to verify the 16plus V2 setup matches the instrument Configuration Sheet (correct internally mounted pressure sensor, voltage sensors assigned to correct channels, etc.).
- Bad data may be caused by incorrect configuration in the instrument .xmlcon or .con configuration file. Verify the settings in the configuration file match the instrument Configuration Sheet.

Note:

Each 16plus V2 is shipped with a configuration (.con) file that matches the configuration of the instrument (number and type of auxiliary sensors, etc.) and includes the instrument calibration coefficients.

Cause/Solution 2: A data file with unreasonable (i.e., out of the expected range) values for temperature, conductivity, etc. may be caused by incorrect calibration coefficients:

- If you manually uploaded data in engineering units (**OutputFormat=1, 3, or 5**) – Bad data may be caused by incorrect calibration coefficients in the 16plus V2. Send **GetCC** or **DCal** to verify the calibration coefficients in the 16plus V2 match the instrument Calibration Certificates. Note that calibration coefficients do not affect the raw data stored in 16plus V2 memory. If you have not yet overwritten the memory with new data, you can correct the coefficients and then upload the data again.
- If you are viewing real-time data in Seasave, manually uploaded data in raw hexadecimal (**OutputFormat=0**), or used Seaterm232's Upload menu to upload data and are processing the data in Seasave or SBE Data Processing - Bad data may be caused by incorrect calibration coefficients in the instrument .xmlcon or .con configuration file. Verify the calibration coefficients in the configuration file match the instrument Calibration Certificates.
- For RS-232 sensors interfacing to the 16plus V2: Bad data may be caused by incorrect calibration coefficients programmed into the RS-232 sensor. Connect the sensor directly to the computer and use Seaterm232 or Seaterm to verify the calibration coefficients match the instrument Calibration Certificate.

Problem 6: Less Data than Expected

Cause/Solution 1: If there is less data than expected, look at the cast header (**GetHeaders:b,e** or **DHb,e**). An example is shown below:

```
hdr 4 13 Mar 2012 08:01:03 samples 438 to 865, int =  
30, stop = stop cmd
```

If the header shows *stop = stop cmd*, this indicates that the **Stop** command was sent from a terminal program. If you didn't send the Stop command, moisture on the data I/O connector may have created a short on the receive and transmit pins (pins 2 and 3 on the Data I/O, Pump, and External Power connector), which could be misinterpreted by the 16plus V2 as a command to stop logging. Check the I/O connector on the end cap, the Y-cable (or 6-pin to 4-pin extender cable) connecting to it, and the data I/O - power cable for moisture or corrosion.

Problem 7: Program Corrupted

Note:

Using the reset switch does not affect the 16plus V2 memory - data in memory and user-programmable parameter values are unaffected.

Cause/Solution 1: In rare cases, the program that controls the 16plus V2 microprocessor can be corrupted by a severe static shock or other problem. This program can be initialized by using the reset switch. Proceed as follows to initialize:

1. Open the battery end cap and remove the batteries (see *Replacing Alkaline Batteries* in *Section 5: Routine Maintenance and Calibration*).
2. There is a small, pushbutton switch on the battery compartment bulkhead, which is visible after the batteries are removed. The switch is used to disconnect the internal back-up lithium batteries from the electronics. Push the switch in for 1 sec.
3. Reinstall or replace the batteries, and close the battery end cap.
4. Establish communications with the 16plus V2 (see *Section 3: Power and Communications Test*). Send **GetSD** or **DS** to verify that the date and time and sample number are correct.

Glossary

Note:

All Sea-Bird software listed was designed to work with a computer running Windows 2000/XP. Extensive testing has not shown any compatibility problems when using the software with a computer running Windows Vista or Windows 7 (32-bit).

Batteries – Nine alkaline D-cells (Duracell MN1300, LR20) standard.

Deployment Endurance Calculator – Sea-Bird’s Windows 2000/XP software used to calculate deployment length for moored instruments, based on user-input deployment scheme, instrument power requirements, and battery capacity.

Fouling – Biological growth in the conductivity cell during deployment.

PCB – Printed Circuit Board.

SBE Data Processing – Sea-Bird’s Win 2000/XP data processing software, which calculates and plots temperature, conductivity, and optional internally mounted pressure, data from auxiliary sensors, and derived variables such as salinity and sound velocity.

Scan – One data sample containing temperature, conductivity, optional internally mounted pressure, date and time, and optional auxiliary inputs.

SeaCAT – High-accuracy conductivity, temperature, and pressure recorder. The SeaCAT is available as the SBE 16*plus* (moored applications) and SBE 19*plus* (moored or profiling applications).

The 16*plus* is available in two versions:

- 16*plus* with **RS-232** interface (standard, **this manual**)
- 16*plus*-IM with **inductive modem** interface

Version 2 (V2) models of each of these instruments became available in late 2007 /early 2008, and have 2 additional A/D channels (for a total of 6), a standard channel for an RS-232 sensor, and larger memory (64 MB).

Seasave V7 – Sea-Bird’s Win 2000/XP software used to acquire, convert, and display real-time or archived raw data.

Seasoft V2 – Sea-Bird’s complete Win 2000/XP software package, which includes software for communication, real-time data acquisition, and data analysis and display. Seasoft V2 includes **Deployment Endurance Calculator**, **SeatermV2**, **Seaterm**, **Seasave V7**, and **SBE Data Processing**.

Seaterm – Sea-Bird’s older Win 95/98/NT/2000/XP terminal program, used to communicate with the SBE 38 or SBE 50

SeatermV2 – Win 2000/XP terminal program *launcher*. Depending on the instrument selected, it launches Seaterm232 (RS-232 instruments), Seaterm485 (RS-485 instruments), or SeatermIM (inductive modem instruments).

Seaterm232 – Win 2000/XP terminal program used with Sea-Bird instruments that communicate via an RS-232 interface, and that were developed or redesigned in 2006 and later. The common feature of these instruments is the ability to output data in XML.

Super O-Lube – Silicone lubricant used to lubricate O-rings and O-ring mating surfaces. Super O-Lube can be ordered from Sea-Bird, but should also be available locally from distributors. Super O-Lube is manufactured by Parker Hannifin (www.parker.com/ead/cm2.asp?cmid=3956).

TCXO – Temperature Compensated Crystal Oscillator.

Triton X-100 – Reagent grade non-ionic surfactant (detergent), used for cleaning the conductivity cell. Triton can be ordered from Sea-Bird, but should also be available locally from chemical supply or laboratory products companies. Triton is manufactured by Avantor Performance Materials (www.avantormaterials.com/commerce/product.aspx?id=2147509608).

Appendix I: Functional Description and Circuitry

Sensors

The SBE16*plus* V2 embodies the same sensor elements (3-electrode, 2-terminal, borosilicate glass cell, and pressure-protected thermistor) previously employed in Sea-Bird's modular SBE 3 and SBE 4 sensors and in the original SeaCAT design. The SBE 16*plus* V2 differs from the SBE 16 in that it uses three independent channels to digitize temperature, conductivity, and internally mounted pressure concurrently. Multiplexing is not used for these channels.

The optional internally mounted pressure sensor is a strain-gauge or a Quartz sensor.

Sensor Interface

Temperature is acquired by applying an AC excitation to a bridge circuit containing an ultra-stable aged thermistor with a drift rate of less than 0.002 °C per year. The other elements in the bridge are VISHAY precision resistors. A 24-bit A/D converter digitizes the output of the bridge. AC excitation and ratiometric comparison avoids errors caused by parasitic thermocouples, offset voltages, leakage currents, and reference errors.

Conductivity is acquired using an ultra-precision Wein-Bridge oscillator to generate a frequency output in response to changes in conductivity.

Internally mounted strain-gauge pressure is acquired by applying an AC excitation to the pressure bridge. A 24-bit A/D converter digitizes the output of the bridge. AC excitation and ratiometric comparison avoids errors caused by parasitic thermocouples, offset voltages, leakage currents, and reference errors. A silicon diode embedded in the pressure bridge is used to measure the temperature of the pressure bridge. This temperature is used to perform offset and span corrections on the measured pressure signal.

The six external 0 to 5 volt DC voltage channels are processed by differential amplifiers with an input resistance of 50K ohms and are digitized with a 14-bit A/D converter.

Real-Time Clock

To minimize power and improve clock accuracy, a temperature-compensated crystal oscillator (TCXO) is used as the real-time-clock frequency source. The TCXO is accurate to ± 1 minute per year (0 °C to 40 °C).

Battery Wiring

SBE 16*plus* V2 main battery is a series connection of D-cells that drop into the battery compartment as a cluster of end-to-end stacks, three batteries each (standard 9-cell battery pack has three stacks). The positive battery connections are contact areas on double-thick printed circuit disks that form the internal bulkhead and battery retainer plates. Battery negative contacts are heavy beryllium-copper springs. The three cell stacks are aligned by plastic insulated aluminum spacers which also serve as electrical interconnects. The battery-to-circuit card connection is made by means of a Molex-type 3-pin pc board connector (JP3 on the power PCB).

The Power PCB contains three series-connected Panasonic BR-2/3A lithium cells (non-hazardous) which are diode OR'd with the main battery (and external power source, if used). The back-up lithium supply is capable of maintaining the buffer and the real-time clock if the main batteries and/or external power are removed. If the back-up lithium battery voltage (*V_{lith}* in the **GetSD** or **DS** response) falls below 7 volts, replace the back-up batteries.

Appendix II: Electronics Disassembly/Reassembly

CAUTION:

Use caution during disassembly and reassembly to avoid breaking the conductivity cell.

Disassembly

Do not remove screw
attaching guard to
sensor end cap
(2 places)

Remove screw
(2 places)

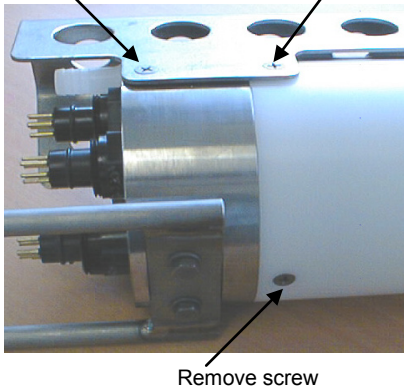

1. As a precaution, upload any data in memory before beginning.
2. Remove the two Phillips-head screws holding the conductivity cell guard to the housing. **Do not remove the two screws holding the conductivity cell guard to the sensor end cap.**
3. Remove the Phillips-head screw holding the sensor end cap to the housing on the side opposite the conductivity cell guard.
4. Remove the sensor end cap (with attached conductivity cell and cell guard) and electronics:
 - A. Wipe the outside of the sensor end cap and housing dry, being careful to remove any water at the seam between them.
 - B. Slide the end cap and attached electronics out of the housing.
 - C. The electronics are electrically connected to the battery compartment bulkhead with a Molex connector. Disconnect the Molex connector.
 - D. Remove any water from the O-rings and mating surfaces inside the housing with a lint-free cloth or tissue.
 - E. Be careful to protect the O-rings from damage or contamination.

Reassembly

Note:

Before delivery, a desiccant package is placed in the electronics chamber, and the electronics chamber is filled with dry Argon gas. These measures help prevent condensation.

If the electronics are exposed to the atmosphere, dry gas backfill with Argon and replace the desiccant package.

See *Application Note 71: Desiccant Use and Regeneration (drying)* for desiccant information.

Battery replacement does not affect desiccation of the electronics, as no significant gas exchange is possible unless the electronics PCBs are actually removed from the housing.

1. Reinstall the sensor end cap, conductivity cell and guard, and electronics:
 - A. Remove any water from the O-rings and mating surfaces in the housing with a lint-free cloth or tissue. Inspect the O-rings and mating surfaces for dirt, nicks, and cuts. Clean or replace as necessary. Apply a light coat of O-ring lubricant (Parker Super O Lube) to the O-rings and mating surfaces.
 - B. Plug the Molex connector onto the pins on the battery compartment bulkhead. Verify the connector holes and pins are properly aligned.
 - C. Carefully fit the end cap and electronics into the housing until the O-rings are fully seated.
2. Reinstall the three screws to secure the end cap.
3. Reset the date and time (**DateTime=**) and initialize logging (**InitLogging**) before redeploying. No other parameters should have been affected by electronics disassembly (send **GetCD** or **DS** to verify).

Appendix III: Command Summary

CATEGORY	COMMAND	DESCRIPTION
Status	GetCD	Get and display configuration data (setup parameters).
	GetSD	Get and display status data.
	GetCC	Get and display calibration coefficients.
	GetEC	Get and display event counter data.
	ResetEC	Delete all events in event counter
	GetHD	Get and display hardware data.
	DS	Get and display configuration data (setup parameters) and status data.
General Setup	DCal	Get and display calibration coefficients.
	DateTime= mmddyyhhmmss	Set real-time clock month, day, year, hour, minute, second.
	BaudRate=x	x= baud rate (600, 1200, 2400, 4800, 9600, 19200, 38400, 57600, or 115200). Default 9600.
	Echo=x	x=Y: Echo characters as you type. x=N: Do not.
	OutputExecutedTag=x	x=Y: Display XML Executing and Executed tags. x=N: Do not.
	TxRealTime=x	x=Y: Output real-time data. x=N: Do not.
	PumpMode=x	x=0: No pump. x=1: Run pump for 0.5 sec before each sample. x=2: Run pump during each sample.
	NCycles=x	x= number of measurements to take and average for each sample. Default 1.
	InitLogging	After all previous data uploaded, send this before starting to sample to make entire memory available for recording. If not sent, data stored after last sample.
	SampleNumber=x	x= sample number for last sample in memory.
	HeaderNumber=x	x= header number for last header in memory.
	Biowiper=x	x=Y: Configuration includes WET Labs sensor with Bio-Wiper (voltage or RS-232 auxiliary sensor). x=N (default): Does not.
Pressure Sensor Setup	QS	Enter quiescent (sleep) state. Main power turned off, but data logging and memory retention unaffected.
	PType=x	Internally mounted pressure sensor type (set at factory; do not modify) - x=0: No internally mounted pressure sensor. x=1: Strain gauge. x=3: Quartz with temperature compensation.
	RefPress=x	x= reference pressure (gauge) in db to use if 16plus V2 does not include internally mounted pressure sensor.
Voltage Sensor Setup	ParosIntegration=x	x= integration time (sec) for optional internally mounted Quartz pressure sensor (1 - 600 sec; default 1 sec).
	Volt0=x	x=Y: Enable external voltage 0. x=N: Do not.
	Volt1=x	x=Y: Enable external voltage 1. x=N: Do not.
	Volt2=x	x=Y: Enable external voltage 2. x=N: Do not.
	Volt3=x	x=Y: Enable external voltage 3. x=N: Do not.
	Volt4=x	x=Y: Enable external voltage 4. x=N: Do not.
	Volt5=x	x=Y: Enable external voltage 5. x=N: Do not.
	DelayBeforeSampling =x	x= time (sec) to wait after switching on external voltages and RS-232 sensors before sampling (0-600 sec). Default 0.
DelayAfterSampling =x	x= time (sec) to wait after sampling is completed, before turning off power to external voltages and RS-232 sensors (0-100 sec). Default 0.	

CATEGORY	COMMAND	DESCRIPTION
RS-232 Sensor Setup	SBE63=x	x=Y: Enable SBE 63. x=N: Do not.
	Send63=command	Command 16plus V2 to send command to SBE 63 and receive response (command can be any command recognized by SBE 63).
	SBE38=x	x=Y: Enable SBE 38. x=N: Do not.
	SBE50=x	x=Y: Enable SBE 50. x=N: Do not.
	WetLabs=x	x=Y: Enable WET Labs RS-232 sensor. x=N: Do not.
	GTD=x	x=Y: Enable GTD. x=N: Do not.
	DualGTD=x	x=Y: Enable dual (2) GTDs. x=N: Do not.
	TGTD	Measure GTD(s), output converted data for each.
	SendGTD=command	Command 16plus V2 to send command to GTD and receive response (command can be any command recognized by GTD).
	Optode=x	x=Y: Enable Aanderaa Optode. x=N: Do not.
SendOptode=command	Command 16plus V2 to send command to Optode and receive response (command can be any command recognized by Optode).	
Output Format Setup	OutputFormat=x	x=0: output raw frequencies and voltages in Hex (required if using Seasave or SBE Data Processing). x=1: output converted data in Hex. x=2: output raw frequencies and voltages in decimal. x=3: output converted data in decimal. x=5: output converted data in decimal, in XML.
	OutputSal=x	x=Y: Calculate and output salinity (psu). Only applies if OutputFormat=3 or 5 . x=N: Do not.
	OutputSV=x	x=Y: Calculate and output sound velocity (m/sec). Only applies if OutputFormat=3 or 5 . x=N: Do not.
	OutputUCSD=x	x=Y: Calculate and output density sigma-t (kg/m ³), battery voltage, and operating current (mA) with data polled while logging. Only applies if OutputFormat=3 or 5 . x=N: Do not.
Autonomous Sampling (logging)	SampleInterval=x	x= interval (sec) between samples (10 - 14,400).
	StartNow	Start autonomous sampling now.
	StartDateTime= mmddyyyyhhmmss	Delayed start: month, day, year, hour, minute, second.
	StartLater	Start autonomous sampling at StartDateTime= .
	Stop	Stop autonomous sampling or stop waiting to start autonomous sampling. Press Enter key before sending Stop . Must stop sampling before uploading.
Polled Sampling	SL	Output last sample from buffer and leave power on.
	SLT	Output last sample from buffer, then take new sample and store data in buffer. Leave power on.
	TS	Take sample, store data in buffer, output data, and leave power on.
	TSS	Take sample, store in buffer and FLASH memory , output data, and turn power off.
	TSSOn	Take sample, store in buffer and FLASH memory , output data, and leave power on.
	GetLastSamples:x	Output last x samples from FLASH memory.
Serial Line Sync	SyncMode=x	x=Y: enable serial line sync mode. When RS-232 RX line is high (3-10 VDC) for 1-1000 msec, 16plus V2 takes a sample, stores data in FLASH memory, and (if TxRealTime=Y) transmits real-time data. x=N: disable serial line sync mode.
	SyncWait=x	x= time (sec) 16plus V2 monitors RS-232 line for commands after executing take sample command. Range 0 - 120 sec; default 0 sec.
Data Upload Stop autonomous sampling before upload.	GetSamples:b,e or DDb,e	Upload data from scan b to scan e .
	GetHeaders:b,e or DHb,e	Upload header b to header e .

Note:
Use Seaterm232's Upload menu to upload data that will be processed by SBE Data Processing. Manually entering the data upload command does not produce data with the required header information for processing by SBE Data Processing.

CATEGORY	COMMAND	DESCRIPTION
Testing Takes and outputs 100 samples for each test (except as noted). Press Esc key or send a break character to stop test.	TC	Measure conductivity, output converted data.
	TCR	Measure conductivity, output raw data.
	TT	Measure temperature, output converted data.
	TTR	Measure temperature, output raw data
	TP	Measure internally mounted pressure, output converted data.
	TPR	Measure internally mounted pressure, output raw data.
	TV	Measure 6 external voltage channels, output converted data.
	TVR	Measure 6 external voltage channels, main battery voltage, lithium battery voltage, external current, pressure temperature; output raw data.
	TF	Measure frequency (internally mounted Quartz pressure sensor), output converted data.
	TFR	Measure frequency (internally mounted Quartz pressure sensor), output raw data.
	T63	Measure SBE 63, output data.
	T38	Measure SBE 38, output converted data.
	T50	Measure SBE 50 pressure, output converted data.
	TWetLabs	Measure WET Labs RS-232 sensor, output raw data.
	TOptode	Measure Aanderaa Optode, output converted data.
PumpOn	Turn pump on for testing purposes.	
PumpOff	Turn pump off for testing purposes.	
Calibration Coefficients (F=floating point number; S=string with no spaces) Dates shown are when calibrations were performed. Calibration coefficients are initially factory-set and should agree with Calibration Certificates shipped with 16plus V2. Pressure sensor coefficients are for internally mounted pressure sensor. View all coefficients with GetCC or DCal .	TCalDate=S	S=Temperature calibration date.
	TA0=F	F=Temperature A0.
	TA1=F	F=Temperature A1.
	TA2=F	F=Temperature A2.
	TA3=F	F=Temperature A3.
	TOffset=F	F=Temperature offset correction.
	CCalDate=S	S=Conductivity calibration date.
	CG=F	F=Conductivity G.
	CH=F	F=Conductivity H.
	CI=F	F=Conductivity I.
	CJ=F	F=Conductivity J.
	CPCor=F	F=Conductivity pcor.
	CTCor=F	F=Conductivity tcor.
	CSlope=F	F=Conductivity slope correction.
	PCalDate=S	S=Pressure calibration date.
	PRange=F	F=Pressure sensor full scale range (psia).
	POffset=F	F=Pressure offset correction.
	PA0=F	F=Strain gauge pressure A0.
	PA1=F	F=Strain gauge pressure A1.
	PA2=F	F=Strain gauge pressure A2.
	PTempA0=F	F=Strain gauge pressure temperature A0.
	PTempA1=F	F=Strain gauge pressure temperature A1.
	PTempA2=F	F=Strain gauge pressure temperature A2.
	PTCA0=F	F=Strain gauge pressure temperature compensation ptca0.
	PTCA1=F	F=Strain gauge pressure temperature compensation ptca1.
	PTCA2=F	F=Strain gauge pressure temperature compensation ptca2.
	PTCB0=F	F=Strain gauge pressure temperature compensation ptcb0.
	PTCB1=F	F=Strain gauge pressure temperature compensation ptcb1.
	PTCB2=F	F=Strain gauge pressure temperature compensation ptcb2.
	PC1=F	F=Quartz pressure C1.
	PC2=F	F=Quartz pressure C2.
	PC3=F	F=Quartz pressure C3.
	PD1=F	F=Quartz pressure D1.
PD2=F	F=Quartz pressure D2.	
PT1=F	F=Quartz pressure T1.	
PT2=F	F=Quartz pressure T2.	
PT3=F	F=Quartz pressure T3.	
PT4=F	F=Quartz pressure T4.	
PSlope=F	F=Quartz pressure slope correction.	

CATEGORY	COMMAND	DESCRIPTION
Hardware Configuration		<i>Auxiliary Sensor Settings – can be modified in the field to accommodate changes in auxiliary sensors cabled to 16plus V2</i> SetVoltType0=, SetVoltSN0= SetVoltType1=, SetVoltSN1= SetVoltType2=, SetVoltSN2= SetVoltType3=, SetVoltSN3= SetVoltType4=, SetVoltSN4= SetVoltType5=, SetVoltSN5= SetSerialType=, SetSerialSN=

Appendix IV: AF24173 Anti-Foulant Device

AF24173 Anti-Foulant Devices supplied for user replacement are supplied in polyethylene bags displaying the following label:

AF24173 ANTI-FOULANT DEVICE

FOR USE ONLY IN SEA-BIRD ELECTRONICS' CONDUCTIVITY SENSORS TO CONTROL THE GROWTH OF AQUATIC ORGANISMS WITHIN ELECTRONIC CONDUCTIVITY SENSORS.

ACTIVE INGREDIENT:

Bis(tributyltin) oxide.....	53.0%
OTHER INGREDIENTS:	<u>47.0%</u>
Total.....	100.0%

DANGER

See the complete label within the Conductivity Instrument Manual for Additional Precautionary Statements and Information on the Handling, Storage, and Disposal of this Product.

Net Contents: Two anti-foulant devices

Sea-Bird Electronics, Inc.
13431 NE 20th Street
Bellevue, WA 98005

EPA Registration No. 74489-1
EPA Establishment No. 74489-WA-1

AF24173 Anti-Foulant Device

FOR USE ONLY IN SEA-BIRD ELECTRONICS' CONDUCTIVITY SENSORS TO CONTROL THE GROWTH OF AQUATIC ORGANISMS WITHIN ELECTRONIC CONDUCTIVITY SENSORS.

ACTIVE INGREDIENT:

Bis(tributyltin) oxide.....	53.0%
OTHER INGREDIENTS:	47.0%
Total.....	100.0%

DANGER

See Precautionary Statements for additional information.

FIRST AID	
If on skin or clothing	<ul style="list-style-type: none"> Take off contaminated clothing. Rinse skin immediately with plenty of water for 15-20 minutes. Call a poison control center or doctor for treatment advice.
If swallowed	<ul style="list-style-type: none"> Call poison control center or doctor immediately for treatment advice. Have person drink several glasses of water. Do not induce vomiting. Do not give anything by mouth to an unconscious person.
If in eyes	<ul style="list-style-type: none"> Hold eye open and rinse slowly and gently with water for 15-20 minutes. Remove contact lenses, if present, after the first 5 minutes, then continue rinsing eye. Call a poison control center or doctor for treatment advice.
HOT LINE NUMBER	
Note to Physician	Probable mucosal damage may contraindicate the use of gastric lavage.
Have the product container or label with you when calling a poison control center or doctor, or going for treatment. For further information call National Pesticide Telecommunications Network (NPTN) at 1-800-858-7378.	

Net Contents: Two anti-foulant devices

Sea-Bird Electronics, Inc.
 13431 NE 20th Street
 Bellevue, WA 98005

EPA Registration No. 74489-1
 EPA Establishment No. 74489-WA-1

PRECAUTIONARY STATEMENTS

HAZARD TO HUMANS AND DOMESTIC ANIMALS

DANGER

Corrosive - Causes irreversible eye damage and skin burns. Harmful if swallowed. Harmful if absorbed through the skin or inhaled. Prolonged or frequently repeated contact may cause allergic reactions in some individuals. Wash thoroughly with soap and water after handling.

PERSONAL PROTECTIVE EQUIPMENT

USER SAFETY RECOMMENDATIONS

Users should:

- Remove clothing immediately if pesticide gets inside. Then wash thoroughly and put on clean clothing.
- Wear protective gloves (rubber or latex), goggles or other eye protection, and clothing to minimize contact.
- Follow manufacturer's instructions for cleaning and maintaining PPE. If no such instructions for washables, use detergent and hot water. Keep and wash PPE separately from other laundry.
- Wash hands with soap and water before eating, drinking, chewing gum, using tobacco or using the toilet.

ENVIRONMENTAL HAZARDS

Do not discharge effluent containing this product into lakes, streams, ponds, estuaries, oceans, or other waters unless in accordance with the requirements of a National Pollutant Discharge Elimination System (NPDES) permit and the permitting authority has been notified in writing prior to discharge. Do not discharge effluent containing this product to sewer systems without previously notifying the local sewage treatment plant authority. For guidance contact your State Water Board or Regional Office of EPA. This material is toxic to fish. Do not contaminate water when cleaning equipment or disposing of equipment washwaters.

PHYSICAL OR CHEMICAL HAZARDS

Do not use or store near heat or open flame. Avoid contact with acids and oxidizers.

DIRECTIONS FOR USE

It is a violation of Federal Law to use this product in a manner inconsistent with its labeling. For use only in Sea-Bird Electronics' conductivity sensors. Read installation instructions in the applicable Conductivity Instrument Manual.

STORAGE AND DISPOSAL

PESTICIDE STORAGE: Store in original container in a cool, dry place. Prevent exposure to heat or flame. Do not store near acids or oxidizers. Keep container tightly closed.

PESTICIDE SPILL PROCEDURE: In case of a spill, absorb spills with absorbent material. Put saturated absorbent material to a labeled container for treatment or disposal.

PESTICIDE DISPOSAL: Pesticide that cannot be used according to label instructions must be disposed of according to Federal or approved State procedures under Subtitle C of the Resource Conservation and Recovery Act.

CONTAINER HANDLING: Nonrefillable container. Do not reuse this container for any purpose. Offer for recycling, if available.

Appendix V: Replacement Parts

Part Number	Part	Application Description	Quantity in 16plus V2
22018	Batteries, alkaline D-cell, Duracell MN 1300 (LR20)	Power 16plus V2	9
41124B	Battery cover plate	Retains batteries	1
801483	9D (10.8V / 42 amp-hour) lithium battery pack kit	For longer deployments; batteries not included in kit, and not available from Sea-Bird. Cannot use if 16plus V2 integrated with 5T / 5P pump.	-
801479	3DD (10.8V / 30 amp-hour) lithium battery pack kit	For longer deployments; batteries not included in kit, and not available from Sea-Bird. Cannot use if 16plus V2 integrated with 5T / 5P pump.	-
30411	Triton X-100	Octyl Phenol Ethoxylate – Reagent grade non-ionic cleaning solution for conductivity cell (100% strength; dilute as directed)	1
801542	AF24173 Anti-Foulant Device	bis(tributyltin) oxide device inserted into anti-foulant device cup	1 (set of 2)
231505	Anti-foulant device cap	Secures AF24173 Anti-Foulant Device in cup	2
30984	Anti-foulant device plug	Seals end of anti-foulant assembly when not deployed	2
17762*	6-pin AG-206 to 4-pin RMG-4MP	Data I/O extension cable, for use when configured without pump	1
17709*	6-pin AG-206 to 2-pin RMG-2FS and 4-pin RMG-4MP Pump / Data I/O-Power Y-cable	From SBE 16plus V2 bulkhead connector to pump (2-pin) and data I/O - power (4-pin)	1
801225*	4-pin RMG-4FS to 9-pin DB -9S I/O cable, 2.4 m (8 ft) long	From 4-pin connector on Y-cable 17709 or on 17762 to computer	1
171888	25-pin DB-25S to 9-pin DB-9P cable adapter	For use with computer with DB-25 connector	-
17133*	2-pin RMG-2FS to 2-pin RMG-2FS cable, 1.1 m (3.7 ft.) long	From 2-pin connector on Y-cable 17709 to optional pump	1
17044.1*	2-pin RMG-2FS dummy plug and locking sleeve	For 2-pin connector on Y-cable 17709, when pump not used	1
17046.1*	4-pin RMG-4FS dummy plug and locking sleeve	For 4-pin connector on Y-cable 17709, when I/O cable not used. Also, for 4-pin RS-232 auxiliary sensor connector when not used.	2
17047.1*	6-pin AG-206 dummy plug and locking sleeve	For when auxiliary differential input sensors not used	3
172393	6-pin MCIL-6FS to 4-pin MCIL-4MP	Data I/O extension cable, for use when configured without pump	1
171883	6-pin MCIL-6FS to 2-pin MCIL-2FS and 4-pin MCIL-4MP Pump / Data I/O Y-cable	From 16plus V2 bulkhead connector to pump (2-pin) and data I/O - power (4-pin)	1
801374	4-pin MCIL-4FS (wet-pluggable connector) to 9-pin DB-9S I/O cable, 2.4 m (8 ft) long	From 4-pin connector on Y-cable 171883 or on 172393 to computer	1
171503	2-pin MCIL-2FS to 2-pin MCIL-2FS (wet-pluggable connector) cable, 1.1 m (3.7 ft) long	From 2-pin connector on Y-cable 171883 to pump	1
171497.1	2-pin MCDC-2-F wet-pluggable dummy plug and locking sleeve	For 2-pin connector on Y-cable 171883 when pump not used	1
171398.1	4-pin MCDC-4-F wet-pluggable dummy plug and locking sleeve	For 4-pin connector on Y-cable 171883 when I/O cable not used. Also, for 4-pin RS-232 auxiliary sensor connector when not used.	2
171498.1	6-pin MCDC-6-F wet-pluggable dummy plug and locking sleeve	For unused auxiliary differential input sensor connector	3
30388	Tygon tube, ½ inch ID x ¾ inch OD	Main plumbing tubing for pumped configuration	-
30579	Tygon tube, 3/8 inch ID x ½ inch OD	13 mm (0.5 in.) long pieces used for pumped configurations on conductivity cell exhaust cap & SBE 43 intake & exhaust to fit to main plumbing	-

* For standard bulkhead connectors

continued on next page

continued from previous page

Part Number	Part	Application Description	Quantity in 16plus V2
22009	Panasonic BR-2/3A lithium batteries	Back-up lithium cells on Power PCB	3
50062	Pump O-ring kit	Includes: <ul style="list-style-type: none"> • 30010 Pump thrust washer (insulates each end of impeller against pump shaft) • 30095 Parker 2-002N674-70 (pump impeller retainer) • 30571 Parker 2-124N674-70 (pump head to impeller housing) • 30082 Parker 2-213N1000-70 (pump end cap to housing, 5T pump with retaining ring) • 31011 Parker 2-026 N674-70 (pump end cap to housing, all 5M/5P pumps, and 5T pump without retaining ring) 	-
50391	Pump impeller replacement kit	Includes: <ul style="list-style-type: none"> • 30009 Pump impeller • 30010 Pump thrust washer (insulates each end of impeller against pump shaft) • 30095 Parker 2-002N674-70 (pump impeller retainer) • 30571 Parker 2-124N674-70 (pump head to impeller housing) • 30082 Parker 2-213N1000-70 (pump end cap to housing, 5T pump with retaining ring) • 31011 Parker 2-026 N674-70 (pump end cap to housing, all 5M/5P pumps, and 5T pump without retaining ring) 	-
60021	Spare battery end cap hardware and O-rings	O-rings and hardware, including: <ul style="list-style-type: none"> • 30145 Screw, 6-32 x 1/2 Phillips-head, stainless steel (secures battery cover plate to battery posts) • 30242 Washer, #6 flat, stainless steel (for 30145) • 30816 Parker 2-234E603-70 (battery end cap to housing piston seal, sensor end cap to housing seals) • 30090 Parker 2-153N674-70 (battery end cap to housing face seal) 	-
50274	Spare O-ring kit	Assorted O-rings, including: <ul style="list-style-type: none"> • 30816 Parker 2-234E603-70 (battery end cap to housing piston seal, sensor end cap to housing seals) • 30090 Parker 2-153N674-70 (battery end cap to housing face seal) • 30507 Parker 2-206N674-70 (each end of conductivity cell) • 30802 Parker 2-110DUR070, ethylene (titanium conductivity cell tray face seal, groove surface) • 30809 Morrison seal, .047" hole, NIT (temperature probe Morrison seal) • 30072 Parker 2-017N674-70 (bulkhead connector seal) • 30070 Parker 3-904N674-70 (pressure sensor mounting seal) • 30087 Parker 2-232N674-70 (buffer for top retainer of PCB sandwich assembly) • 30801 Parker 5-374E603-70 (base of battery bulkhead seal) 	-
50273	Spare hardware kit	Assorted hardware, including: <ul style="list-style-type: none"> • 30145 Screw, 6-32 x 1/2 Phillips-head, stainless steel (secures battery cover plate to battery posts) • 30242 Washer, #6 flat, stainless steel (for 30145) • 30414 Washer, #12, internal tooth (secures battery bulkhead retainer) • 30954 Screw 4-40 x 3/16 Phillips-head, stainless steel (securing screw for PCB retainer rod) • 31119 Screw 6-32 x 5/8 Truss Head (secures battery bulkhead retainer to bulkhead bottom plate) • 30176 Screw, 10-24 x 3/4, Phillips-head, stainless steel (secures Celcon threaded ring inside titanium battery end cap) • 30249 Washer #10, Flat, stainless steel (for 30176) • 30447 Bolt, 1/4-20 x 1 1/4 Hex, titanium (secures lift eye to battery end cap) • 31089 Screw, 10-32 x 1/2 flat Phillips-head, titanium (secures sensor end cap to housing - side opposite conductivity cell guard) • 31090 Screw, 10-32 x 5/8 flat Phillips-head, titanium (secures conductivity cell guard to housing) • 31118 Screw, 10-32 x 3/8 Phillips-head, titanium (secures conductivity cell guard to sensor end cap) • 30875 Bolt 1/4-20 x 5/8 Hex, titanium (secures connector guard to sensor end cap) • 30633 Washer, 1/4" split ring lock, titanium (for 30875) • 30919 Screw, 6-32 x 3/8 flat slotted, titanium (secures anti-foulant device cup to conductivity cell guard) • 31066 Screw, 8-32 x 3/4 socket, titanium (secures conductivity cell and TC duct to sensor end cap) 	-

continued on next page

continued from previous page

Part Number	Part	Application Description	Quantity in 16plus V2
50434	Seaspares kit, standard connectors	Includes o-rings, hardware, bulkhead connectors, dummy plugs, etc.: <ul style="list-style-type: none"> • 50087 Conductivity cell filling and storage kit • 50273 Spare hardware kit (see above) • 50274 Spare o-ring kit (see above) • 41124 Battery cover plate • 801225 Data I/O cable, 4-pin RMG-4FS to 9-pin DB -9S I/O cable, 2.4 m (8 ft) long • 17046.1 4-pin RMG-4FS dummy plug with locking sleeve • 17047.1 6-pin AG-206 dummy plug with locking sleeve • 17654 4-pin XSG-4-BCL-HP-SS bulkhead connector • 17628 6-pin AG-306-HP-SS bulkhead connector • 30388 Vinyl tube, 3/4" x 1/2" (main sensor plumbing tubing) • 30409 Teflon tape (for insides of hose clamps) • 30411 Triton X100 (for cell cleaning) • 30457 Parker O-Lube (o-ring lubricant) 	-
50435	Seaspares kit, wet-pluggable connectors	Includes o-rings, hardware, bulkhead connectors, dummy plugs, etc.: <ul style="list-style-type: none"> • 50087 Conductivity cell filling and storage kit • 50273 Spare hardware kit (see above) • 50274 Spare o-ring kit (see above) • 41124 Battery cover plate • 801374 Data I/O cable, 4-pin MCIL-4FS (wet-pluggable connector) to 9-pin DB-9S I/O cable, 2.4 m (8 ft) long • 171192 Locking sleeve • 171398 4-pin MCDC-4-F wet-pluggable dummy plug • 171498 6-pin MCDC-6-F wet-pluggable dummy plug • 172021 4-pin MCBH-4MP(WB), TI 1/2-20 bulkhead connector • 172022 6-pin MCBH-6MP(WB), TI 1/2-20 bulkhead connector • 30388 Vinyl tube, 3/4" x 1/2" (main sensor plumbing tubing) • 30409 Teflon tape (for insides of hose clamps) • 30411 Triton X100 (for cell cleaning) • 30457 Parker O-Lube (o-ring lubricant) 	-

Appendix VI: Manual Revision History

Manual Version	Date	Description
001	11/07	<ul style="list-style-type: none"> Release of firmware version 2 (16plus V2).
002	02/08	<ul style="list-style-type: none"> Change pressure stability specifications to per year instead of per month. Correct Quartz sensor data in specs to 5 bytes/sample (previously said 6 bytes/sample). Update Quartz resolution calculation method. Correct GetEC description, several lines mentioned “Moored mode”; but 16plus V2 is always in moored mode. Add new V2 Seaspares kits in replacement parts list. Add explanation for Hardware configuration commands: customer may change voltage sensor types and serial numbers. Correct XML output in Output Format section, for OutputUCSD=Y and OutputFormat=5 (closing tag for voltage was incorrect).
003	11/08	<ul style="list-style-type: none"> Delete SCPlusV2_RS232 software, add SeatermV2 software. Remove CF0 from DCal response. Remove 33600 from valid baud rates. Expand on how to change baud. Add J1, J2, etc. labeling on internal wiring showing what goes to what connector. Strain gauge pressure sensor maintenance: – design change, no port plug anymore. Add photo of 17762 extension cable to standard shipping items. Update discussion of Y-cable; 16plus V2 ships standard with extender cable (not Y-cable). SBE 50 setup: If using SBE Data Processing, must set SBE 50 format to psia (OutputFormat=1). Add note with StartLater, need to send Stop if want to change setup.
004	07/09	<ul style="list-style-type: none"> Firmware 2.1: add information related to use of Aanderaa Optode as auxiliary RS-232 sensor. Clarify and correct sleep time between samples. Remove PType= from setup examples, mention that factory-set. Add information about Deployment Endurance Calculator, which is installed with Seasoft. Update SeatermV2 screen capture to show SBE 33 and 36 in instrument list. Add screen capture of Send Commands window in SeatermV2, showing commands listed. Update software name. Add statement about compatibility with Vista.
005	12/09	<ul style="list-style-type: none"> Seasave and SBE Data Processing 7.20a: Add information about .xmlcon file. Add more information about operation with GTD auxiliary sensor. Add more information about DelayBeforeSampling: does not apply to Optode. Add more information about GetLastSamples:x; do not need to stop logging before sending command. Correct external power examples to incorporate 16plus V2 current draws (was still showing 16plus current draws). Add CE mark. Update SBE address. Update anti-foul label in Appendix with new Container Handling requirement and new address
006	04/11	<ul style="list-style-type: none"> Firmware 2.2: Add compatibility with WET Labs RS-232 sensors (WetLabs=, TWetLabs); add commands for RS-232 sensor type and serial number (SetSerialType=, SetSerialSN=). Correct explanation of SampleNumber=; does not reset HeaderNumber=. Add information that lithium battery packs are not compatible with use with SBE 5T or 5P pump. Clarify use of DelayBeforeSampling=; applies to all auxiliary sensors except Optode. Clarify that Optode data is acquired after all CTD and other external sensor data. Correct Digiquartz pressure sensor stability specification to 0.02% of full scale range/year. Replacement parts list: update Seaspares kit contents Update SeatermV2 screen. Remove references to Druck pressure sensors. Update photo for conductivity cell maintenance. Correct typos.

Continued on next page

Continued from previous page

007	02/12	<ul style="list-style-type: none"> • Firmware version 2.4c: Add compatibility with SBE 63 Optical Dissolved Oxygen Sensor. • Correct information about SampleNumber=0 resetting header number. • Add information about software compatibility with Windows 7. • Add more troubleshooting information. • Clarify that barbed cap used on intake end for conductivity cell maintenance should never be used for deployment. • Update Triton website information. • Add pump replacement parts to replacement parts list. • Remove commands that should only be used at the factory. • Correct typos.
008	05/12	<ul style="list-style-type: none"> • Firmware version 2.5: Add DelayAfterSampling= command. • Update BioWiper= description to make it more generic (applies to all WET Labs sensors with bio-wipers, not just to ECO-FL). • Update DelayBeforeSampling= description to include recommended value for use with WL sensor with bio-wiper.
009	09/12	<ul style="list-style-type: none"> • Add range for DelayAfterSampling=. • Add recommended pump operation setup when integrated with SBE 63 optical DO sensor. • Add DelayBeforeSampling= information when integrated with WET Labs sensor with bio-wiper. • Delete information on setting of blue LED counter in SBE 63; now factory-set. • Add information on high baud rates limitations, and disabling of automatic time setting tools in Seaterm232 if baud is set to 115200. • Add cable drawings for y-cable, extension cable, and data I/O cable. • Remove references to RS-485 version. • Remove references to <i>plus</i> version of SBE 21. • Fix typos.

Index

•
 .con file · 48, 49, 50, 61, 70, 72, 80, 87
 .xmlcon file · 48, 49, 50, 61, 70, 72, 80, 87

A

Aanderaa Optode · 50
 Anti-Foulant Devices · 101
 replacing · 86
 Autonomous sampling · 29, 56
 Auxiliary sensors · 19, 49, 50

B

Batteries · 10, 15, 70, 95
 replacing · 83
 Battery endurance · 9, 16, 21
 Baud rate · 14, 34, 74
 Bio-Wiper · 46

C

Cable length · 34
 Cables · 13
 Calibration · 10, 87
 Calibration coefficient commands · 61
 CE certification · 3
 Circuitry · 94
 Cleaning · 84, 85
 Clock · 10, 94
 Command summary · 97
 Commands
 autonomous sampling · 29, 56
 Bio-Wiper · 46
 calibration coefficients · 61
 communication · 46
 data format · 55, 63
 data upload · 58, 76
 descriptions · 36
 format · 55, 63
 GTD · 50
 hardware configuration · 62
 logging · 29, 56
 Optode · 50
 output format · 55, 63
 polled sampling · 28, 57
 pressure sensor · 48
 pump · 32, 46
 RS-232 sensor · 50
 SBE 38 · 50
 SBE 50 · 50
 SBE 63 · 50
 serial line sync · 30, 57
 serial sensor · 50
 setup · 46
 status · 37
 testing · 59
 upload · 58, 76
 voltage sensor · 49

WET Labs C-Star · 50
 WET Labs ECO Sensor · 50
 WET Labs ECO Triplet · 50
 WET Labs WETStar · 50
 Communication commands · 46
 Communication defaults · 25
 Conductivity sensor · 94
 calibration · 87
 cleaning · 84
 storing · 84
 Configuration file · 48, 49, 50, 61, 70, 72, 80, 87
 Configuration options · 19
 Connectors · 12, 82
 Corrosion precautions · 82

D

Data bits · 14
 Data format · 55, 63
 Data I/O · 14
 Data processing · 80
 Data storage · 10, 14
 Data upload · 76
 Data upload commands · 58
 Declaration of Conformity · 3
 Deployment
 installation · 71
 setup · 70
 Deployment Endurance Calculator · 9, 16, 21
 Description · 8
 Dimensions · 12

E

Editing data files · 81
 Electronics disassembly/reassembly · 96
 End cap · 12, 82, 83
 External power · *See* Power, external

F

Flooded CTD · 75
 Format · 55, 63
 Functional description · 94

G

Glossary · 92
 GTD · 50

H

Hardware configuration commands · 62

L

Limited liability statement · 2
 Logging · 29, 56

M

Maintenance · 82
 Manual revision history · 108
 Memory · 10, 14
 Modes · *See* Sampling modes

O

Operation
 logging · 29, 56
 Optode · 50
 Output format · 55, 63

P

Parity · 14
 Parker Super O-Lube · 93
 Parts
 replacement · 105
 Plumbing · 19, 20
 Polled sampling · 28, 57
 Power · 10, 15
 endurance · 9, 16, 21
 external · 17
 Pressure sensor · 94
 calibration · 88
 maintenance · 85
 Pressure sensor commands · 48
 Processing data · 80
 Pump · 19
 maintenance · 85
 operation · 32
 Pump commands · 46

Q

Quick start · 6

R

Real-time data acquisition · 72
 Real-time setup
 baud rate · 34
 cable length · 34
 Recovery
 physical handling · 75
 uploading data · 76
 Replacement parts · 105
 Revision history · 108
 Rinsing · 84
 RS-232 · 14
 RS-232 sensors · 50

S

Sample interval · 15
 Sample timing · 15
 Sampling modes · 28
 autonomous · 29, 56
 polled · 28, 57
 serial line sync · 30, 57
 SBE 38 · 50
 SBE 50 · 50
 SBE 63 · 50
 SBE Data Processing · 9, 21, 79, 80
 Seasave · 9, 21, 72, 79
 Seasoft · 9, 21
 Seaterm · 21
 Seaterm232 · 23, 76
 SeatermV2 · 9, 21, 23, 76
 Sensors · 10
 Serial line sync · 30, 57
 Serial sensors · 50
 Setup commands · 46
 Software · 9, 21
 Specifications · 10
 Status commands · 37
 Stop bits · 14
 Storage · 84
 Super O-Lube · 93
 System description · 8

T

Temperature sensor · 94
 calibration · 87
 Terminal program · 9, 21, 23, 76
 Test
 power and communications · 21
 setup · 22
 Testing commands · 59
 Timeout description · 35
 Timing · 15
 Triton · 93
 Troubleshooting · 89

U

Unpacking SBE 16*plus* V2 · 7
 Upload commands · 58
 Uploading data · 76

V

Versions · 108
 Voltage sensors · 49, 94

W

WET Labs C-Star · 50
 WET Labs ECO Sensor · 50
 WET Labs ECO Triplet · 50
 WET Labs WETStar · 50