



3-0515.090

Rev F 01/08



SAFETY INSTRUCTIONS

1. Depressurize and vent system prior to installation or removal.
2. Confirm chemical compatibility before use.
3. DO NOT exceed maximum temperature/pressure specifications.
4. ALWAYS wear safety goggles or faceshield during installation/service.
5. DO NOT alter product construction.



1. Specifications

General Data

Flow Rate Range: 515: 0.3 to 6 m/s (1 to 20 ft/s)
 2536: 0.1 to 6 m/s (0.3 to 20 ft/s)

Pipe Size Range: DN15 to DN1000 (½ in. to 12 in.)

Linearity: ±1% of maximum range

Repeatability: ±0.5% maximum range

Cable Length: 7.6 m (25 ft) standard
 515: 60 m (200 ft.) maximum
 2536: 305 m (1000 ft) maximum

Cable Type: 2-conductor twisted pair w/shield (22 AWG)

Minimum Reynolds Number Required: 4500

Cap Material: Glass Filled Polypropylene (red or blue)
 Wetted Materials:

- Sensor Body: Glass filled Polypropylene (black) or PVDF
- O-Rings: FPM (Std), EPDM or FFPM optional
- Pin: Titanium or Hastelloy-C or PVDF; other material options available
- Rotor: Black PVDF or natural PVDF; optional Tefzel® with or w/o Fluoroloy B® sleeve

Shipping Weight: -X0 0.454 kg (1 lb)
 -X1 0.476 kg (1.04 lbs)
 -X2 0.680 kg (1.50 lbs)
 -X3 0.794 kg (1.75 lbs)
 -X4 0.850 kg (1.87 lbs)
 -X5 1.0 kg (2.20 lbs)
 3519 1.3 kg (2.86 lbs)

2536 Sensor

Frequency: 49 Hz per m/s nominal (15 Hz per ft/s nominal)

Supply voltage: 3.5 to 24 VDC regulated

Supply current: <1.5 mA @ 3.3 to 6 VDC
 <20 mA @ 6 to 24 VDC

Output Type: Open collector transistor, sinking

Output current: 10 mA max.

Chinese RoHS (Go to www.gfsignet.com for details)

Fluid Conditions

Rotor-X Sensor Pressure/Temperature Ratings:

Polypropylene Body:

- 12.5 bar (180 psi) max. @ 20 °C (68 °F)
- 515: 1.7 bar (25 psi) max. @ 90 °C (194 °F)
- 2536: 1.7 bar (25 psi) max. @ 85 °C (185 °F)

PVDF Body:

- 14 bar (200 psi) max @ 20 °C (68 °F)
- 515: 1.7 bar (25 psi) max @ 100 °C (212 °F)
- 2536: 1.7 bar (25 psi) max @ 85 °C (185 °F)

515 Sensor

Frequency: 19.7 Hz per m/s nominal (6 Hz per ft/s)

Amplitude: 3.3 V p/p per m/s nominal (1 V p/p per ft/s)

Source Impedance: 8 kΩ

Chinese RoHS (Go to www.gfsignet.com for details)

515 Sensor

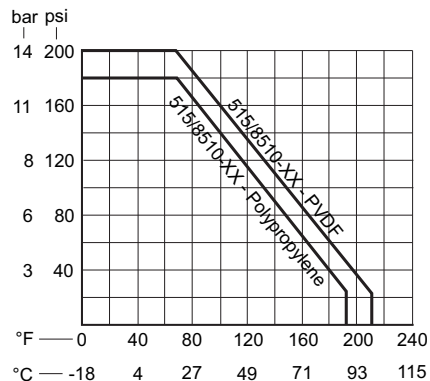

Dimensions

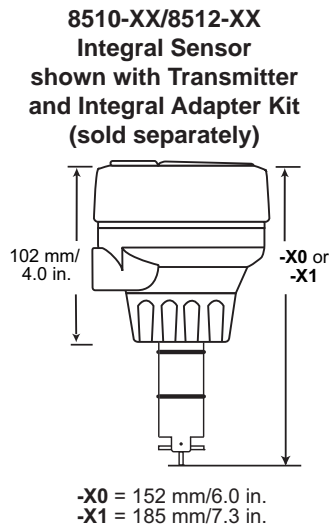
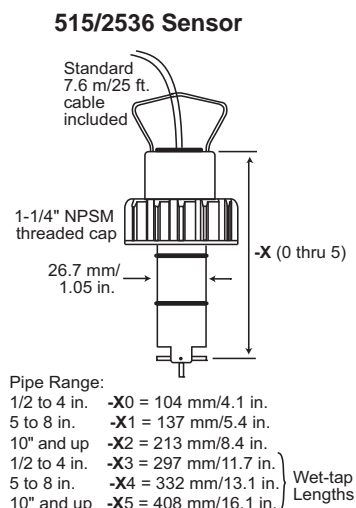

2536 Sensor

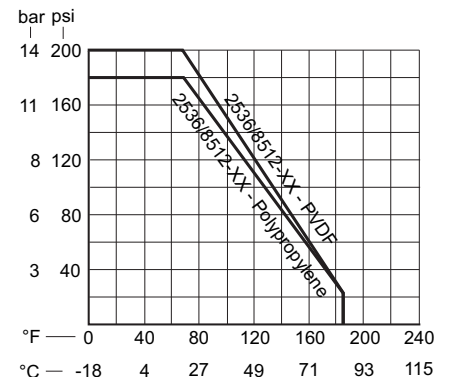

Standards & Approvals

- Manufactured under ISO 9001 and ISO 14001
- CE
- FM (515 Only) IS/ I, II, III / ABCDEFG / T5

2. Location of Fitting

Recommended sensor upstream/downstream mounting requirements

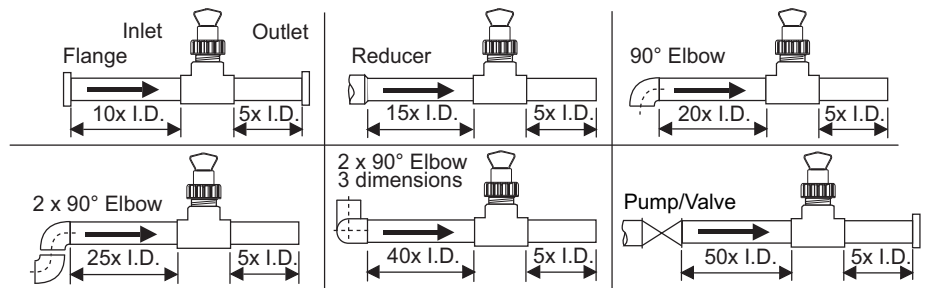

3. Sensor Mounting Position

- Horizontal pipe runs: Mount sensor in the upright (0°) position for best performance. Mount at a maximum of 45° when air bubbles are present (pipe must be full). Do not mount on the bottom of the pipe when sediments are present.
- Vertical pipe runs: Mount sensor in any orientation. Upward flow is preferred to ensure full pipe.

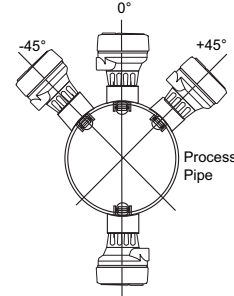

4. Standard Sensor Installation

- Lubricate the sensor O-rings with a suitable lubricant. Do not use any petroleum based lubricant that will attack the O-rings.
- Using an alternating/twisting motion, lower the sensor into the fitting, making sure the installation arrows on the black cap are pointing in the direction of flow, see Figure A.
- Engage one thread of the sensor cap then turn the sensor until the alignment tab is seated in the fitting notch. Hand tighten the sensor cap. DO NOT use any tools on the sensor cap or the cap threads and/or fitting flange threads will be damaged, see Figure B.

Figure A

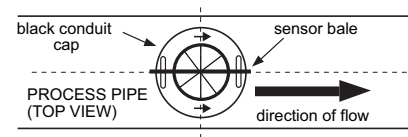
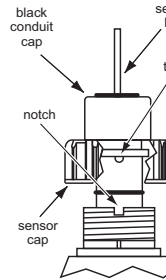

Figure B



5. Sensor Wiring

Technical Notes

- Use 2-conductor shielded cable for cable extensions.
- Cable shield must be maintained through cable splice.
- Refer to your instrument manual for specific wiring details.
- 515 Installations can be made intrinsically safe by installing two Intrinsic Safety barriers (part number 6400-9001).

515 Sensor Connections to Signet Instruments

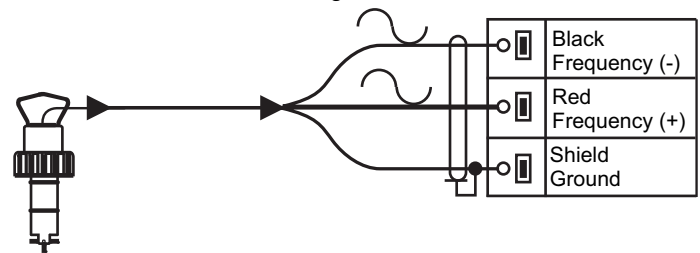

2536 Sensor Connections to Signet Instruments

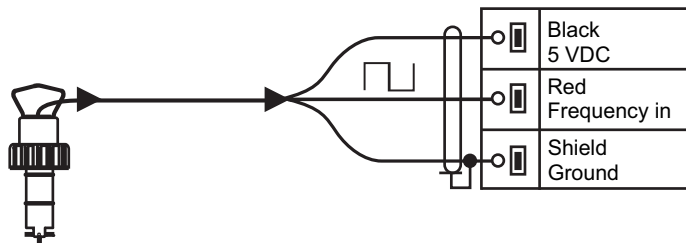

2536 Sensor Connections to Other Brand Instruments

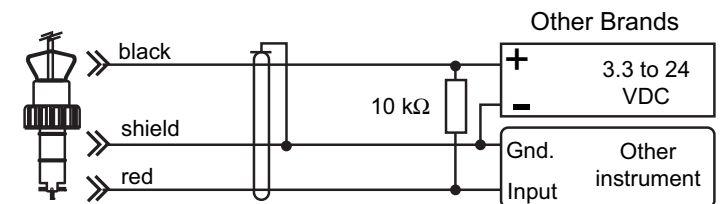

- DC sensor power supplied from Signet instrument.
- 10KΩ Pull-up resistor may be required for non Signet brand instrument.

6. Rotor Replacement Procedure

- To remove the rotor, insert a small screwdriver between the rotor and the ear of the sensor.
- Twist the screwdriver blade to flex the ear outward enough to remove one end of the rotor and pin. DO NOT flex the ear any more than necessary! If it breaks, the sensor cannot be repaired.
- Install the new rotor by inserting one tip of the pin into the hole, then flex the opposite ear back enough to slip rotor into place.

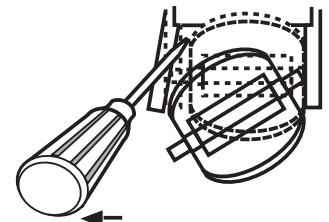

7. K-Factors

A **K-Factor** is the number of pulses a sensor will generate for each engineering unit of fluid that passes the sensor. K-factors for water are listed below in U.S. gallons and liters. For example, in a 1-inch PVC pipe, the 515 paddlewheel generates 174.67 pulses per gallon of water passing the rotor. K-factors are listed for pipes up to 12 inches. For pipes over 12 inches, consult your Signet distributor.

PIPE SIZE (IN.)	FITTING	515/8510-XX		2536/8512-XX	
		U.S. GAL	LITERS	U.S. GAL	LITERS
SCH 80 PVC TEES FOR SCH 80 PVC PIPE					
1/2	PV8T005	480.19	126.87	991.71	262.01
3/4	PV8T007	257.72	68.090	545.14	144.03
1	PV8T010	174.67	46.148	352.44	93.114
1-1/4	PV8T012	83.390	22.032	177.18	46.812
1-1/2	PV8T015	58.580	15.477	117.85	31.137
2	PV8T020	32.480	8.5812	66.739	17.633
2-1/2	PV8T025	21.833	5.7683	42.994	11.359
3	PV8T030	13.541	3.5775	26.652	7.0414
4	PV8T040	7.6258	2.0147	15.006	3.9645
SCH 80 CPVC TEES FOR SCH 80 CPVC PIPE					
1/2	CPV8T005	480.19	126.87	991.71	262.01
3/4	CPV8T007	257.72	68.090	545.14	144.03
1	CPV8T010	174.67	46.148	352.44	93.114
1-1/4	CPV8T012	83.390	22.032	177.18	46.812
1-1/2	CPV8T015	58.580	15.477	117.85	31.137
SCH 80 PVC SADDLES FOR SCH 80 PVC PIPE					
1/2	PV8S020	32.480	8.5812	66.739	17.633
2-1/2	PV8S025	21.833	5.7683	42.994	11.359
3	PV8S030	13.541	3.5775	26.652	7.0414
4	PV8S040	7.6258	2.0147	15.006	3.9645
6	PV8S060	4.1623	1.0997	8.3246	2.1994
8	PV8S080	2.3705	0.6263	5.0164	1.3253
10	PV8S100	1.5300	0.4042	3.0600	0.808
12	PV8S120	1.0600	0.2801	2.1600	0.571
SCH 80 PVC SADDLE ON SCH 40 PVC PIPE					
1/2	PV8S020	27.350	7.2259	54.700	14.452
2-1/2	PV8S025	18.874	4.9866	37.159	9.8175
3	PV8S030	12.638	3.3389	23.697	6.2608
4	PV8S040	6.7282	1.7776	13.456	3.5552
6	PV8S060	3.7297	0.9854	7.4594	1.9708
8	PV8S080	2.1527	0.5688	4.5292	1.1966
10	PV8S100	1.3500	0.3567	2.8000	0.740
12	PV8S120	0.9600	0.2536	1.9800	0.523
PP CLAMP-ON SADDLE ON SCH 80 PP PIPE					
10	PPS100	1.5300	0.4042	3.0600	0.808
12	PPS120	1.0600	0.2801	2.1600	0.571
PP CLAMP-ON SADDLE ON SCH 40 PP PIPE					
10	PPS100	1.3500	0.3567	2.8000	0.740
12	PPS120	0.9600	0.2536	1.9800	0.523

PIPE SIZE (IN.)	FITTING	515/8510-XX		2536/8512-XX	
		U.S. GAL	LITERS	U.S. GAL	LITERS
CARBON STEEL TEES ON SCH 40 PIPE					
1/2	CS4T005	370.20	97.808	756.00	199.74
3/4	CS4T007	212.06	56.027	438.69	115.90
1	CS4T010	141.14	37.289	286.78	75.768
1-1/4	CS4T012	60.655	16.025	121.22	32.026
1-1/2	CS4T015	45.350	11.982	91.139	24.079
2	CS4T020	26.767	7.0717	54.468	14.391
STAINLESS STEEL TEES ON SCH 40 PIPE					
1/2	CR4T005	358.96	94.838	734.20	193.98
3/4	CR4T007	202.61	53.530	412.10	108.88
1	CR4T010	127.14	33.590	252.70	66.764
1-1/4	CR4T012	61.910	16.357	128.12	33.849
1-1/2	CR4T015	40.410	10.676	77.320	20.428
2	CR4T020	22.300	5.8917	45.780	12.095
GALVANIZED IRON TEES ON SCH 40 PIPE					
1	IR4T010	104.54	27.619	213.01	56.277
1-1/4	IR4T012	62.979	16.639	127.75	33.751
1 1/2	IR4T015	46.688	12.335	94.401	24.941
2	IR4T020	29.459	7.7832	59.420	15.699
BRONZE TEES ON SCH 40 PIPE					
1	BR4T010	104.54	27.619	213.01	56.277
1-1/4	BR4T012	62.979	16.639	127.75	33.751
1-1/2	BR4T015	46.688	12.335	94.401	24.941
2	BR4T020	29.459	7.7832	59.420	15.699
COPPER TEE FITTINGS ON COPPER PIPE SCH K					
1/2	CUKT005	443.21	117.10	917.84	242.50
3/4	CUKT007	212.16	56.052	428.27	113.15
1	CUKT010	127.18	33.600	256.43	67.749
1-1/4	CUKT012	68.218	18.007	136.87	36.115
1-1/2	CUKT015	56.962	15.049	115.69	30.565
2	CUKT020	29.370	7.7595	63.385	16.746
COPPER TEE FITTINGS ON COPPER PIPE SCH L					
1/2	CUKT005	414.41	109.49	858.22	226.74
3/4	CUKT007	191.09	50.485	385.74	101.91
1	CUKT010	119.84	31.662	241.64	63.841
1-1/4	CUKT012	85.451	22.576	170.90	45.152
1-1/2	CUKT015	55.160	14.573	112.03	29.598
2	CUKT020	28.605	7.5575	61.74	16.310

PIPE SIZE (IN.)	FITTING	515/8510-XX		2536/8512-XX	
		U.S. GAL	LITERS	U.S. GAL	LITERS
STAINLESS STEEL WELDOLETS ON SCH 40 PIPE					
2-1/2	CR4W025	18.800	4.9670	37.600	9.9339
3	CR4W030	12.170	3.2153	24.340	6.4306
4	CR4W040	6.9600	1.8388	13.920	3.6777
5	CR4W050	5.2600	1.3897	10.680	2.8692
6	CR4W060	3.6900	0.9749	7.5200	1.9868
8	CR4W080	2.1300	0.5627	4.3400	1.1466
10	CR4W100	1.3500	0.3567	2.7600	0.7292
12	CR4W120	0.9600	0.2536	1.9400	0.5125
CARBON STEEL WELDOLETS ON SCH 40 PIPE					
2-1/2	CS4W025	18.800	4.9670	37.600	9.9339
3	CS4W030	12.170	3.2153	24.340	6.4306
4	CS4W040	6.9600	1.8388	13.920	3.6777
5	CS4W050	5.2600	1.3897	10.680	2.8692
6	CS4W060	3.6900	0.9749	7.5200	1.9868
8	CS4W080	2.1300	0.5627	4.3400	1.1466
10	CS4W100	1.3500	0.3567	2.7600	0.7292
12	CS4W120	0.9600	0.2536	1.9400	0.5125
COPPER/BRONZE BRAZOLETS ON SCH 40 PIPE					
2-1/2	BR4B025	18.800	4.9670	37.600	9.934
3	BR4B030	12.170	3.2153	24.340	6.431
4	BR4B040	6.9600	1.8388	13.920	3.678
5	BR4B050	5.2600	1.3897	10.680	2.869
6	BR4B060	3.6900	0.9749	7.5200	1.987
8	BR4B080	2.1300	0.5627	4.3400	1.147
10	BR4B100	1.3500	0.3567	2.7600	0.729
12	BR4B120	0.9600	0.2536	1.9400	0.513
SCH 80 IRON SADDLES ON SCH 80 PIPE					
2	IR8S020	32.360	8.5495	64.720	17.099
2-1/2	IR8S025	22.220	5.8705	42.480	11.223
3	IR8S030	13.420	3.5456	26.840	7.098
4	IR8S040	7.6600	2.0238	15.320	4.038
5	IR8S050	5.8600	1.5482	11.720	3.128
6	IR8S060	4.0900	1.0806	8.1800	2.160
8	IR8S080	2.3300	0.6156	4.6600	1.235
10	IR8S100	1.5300	0.4042	3.0600	0.808
12	IR8S120	1.0600	0.2801	2.1600	0.571
SCH 80 IRON SADDLE ON SCH 40 PIPE					
2	IR8S020	26.820	7.0859	53.640	14.172
2-1/2	IR8S025	18.800	4.9670	37.600	9.934
3	IR8S030	11.990	3.1678	23.920	6.135
4	IR8S040	6.8500	1.8098	13.700	3.503
5	IR8S050	5.3300	1.4082	10.660	2.817
6	IR8S060	3.7600	0.9934	7.5200	1.913
8	IR8S080	2.1300	0.5627	4.4000	1.162
10	IR8S100	1.3500	0.3567	2.8000	0.740
12	IR8S120	0.9600	0.2536	1.9800	0.523

K-Factors DIN Pipes

PIPE SIZE	FITTING	515/8510-XX		2536/8512-XX		CODE
		U.S. GAL	LITERS	U.S. GAL	LITERS	
POLYPROPYLENE FITTINGS (DIN/ISO AND BS AND ANSI)						
DN 15	PPMT005	481.55	127.23	952.87	251.75	198.150.522
DN 20	PPMT007	277.09	73.207	563.10	148.77	198.150.523
DN 25	PPMT010	141.18	37.300	291.60	77.042	198.150.524
DN 32	PPMT012	83.540	22.071	169.22	44.709	198.150.525
DN 40	PPMT015	51.265	13.544	103.90	27.450	198.150.526
DN 50	PPMT020	29.596	7.8193	60.789	16.060	198.150.527
PVDF FITTINGS (DIN/ISO AND BS AND ANSI)						
DN 15	SFMT005	420.87	111.19	827.26	218.56	198.150.529
DN 20	SFMT007	228.15	60.277	489.87	129.42	198.150.530
DN 25	SFMT010	136.70	36.116	283.55	74.915	198.150.531
DN 32	SFMT012	79.294	20.950	158.59	41.899	198.150.532
DN 40	SFMT015	43.490	11.490	86.980	22.980	198.150.533
DN 50	SFMT020	25.908	6.8450	50.385	13.312	198.150.534
PVC FITTINGS (DIN/ISO) - EUROPE ONLY						
DN 15	PVMT005	486.18	128.45	972.37	256.90	198.150.480
DN 20	PVMT007	242.85	64.160	485.69	128.32	198.150.481
DN 25	PVMT010	148.64	39.270	297.274	78.540	198.150.482
DN 32	PVMT012	85.125	22.490	170.249	44.980	198.150.483
DN 40	PVMT015	51.855	13.700	103.709	27.400	198.150.484
DN 50	PVMT020	29.750	7.8600	59.500	15.720	198.150.485





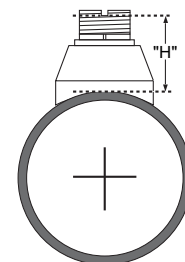





8. H-Dimensions

The plastic sensor insert in the Weldolet fitting **MUST** be removed during the welding process. When reinstalled, it is important that the insert be threaded to the proper height ("H" dimension).



Weldolet part number	"H" dimension		Weldolet part number	"H" dimension	
	inches	mm		inches	mm
CS4W020	2.38	60.45	CS4W240	4.16	105.66
CS4W025	2.33	59.18	CS4W360	4.10	104.14
CS4W030	2.32	58.92			
CS4W040	2.30	58.42	CR4W020	2.38	60.45
CS4W050	3.09	78.48	CR4W025	2.33	59.18
CS4W060	2.96	75.18	CR4W030	2.32	58.92
CS4W080	2.73	69.34	CR4W040	2.30	58.42
CS4W100	5.48	139.19	CR4W050	3.09	78.48
CS4W120	5.25	133.35	CR4W060	2.96	75.18
CS4W140	5.10	129.54	CS		

9. Signet Fittings

Type	Description	Type	Description
Plastic tees 	<ul style="list-style-type: none"> • 0.5 to 4 inch versions • PVC or CPVC 	Iron, Carbon Steel, 316 SS Threaded tees 	<ul style="list-style-type: none"> • 0.5 to 2 in. versions • Mounts on threaded pipe ends
PVC Glue-on Saddles 	<ul style="list-style-type: none"> • Available in 10 and 12 inch sizes only • Cut 2-1/2 inch hole in pipe • Weld in place using solvent cement 	Carbon steel & stainless steel Weld-on Weldolets 	<ul style="list-style-type: none"> • 2 to 4 inch, cut 1-7/16 inch hole in pipe • Over 4 inch, cut 2-1/8 inch hole in pipe
PVC Saddles 	<ul style="list-style-type: none"> • 2 to 4 inch, cut 1-7/16 inch hole in pipe • 6 to 8 inch, cut 2-1/8 inch hole in pipe 	Fiberglass tees & saddles: FPT  FPS 	<ul style="list-style-type: none"> • 1.5 in. to 8 in. PVDF insert • > 8 in. PVC insert • Special order 12 in. to 36 in.
PP Clamp-on Saddles 	<ul style="list-style-type: none"> • Available in 10 and 12 inch sizes only • Cut 2-1/8 inch hole in pipe 	Metric Union Fitting 	<ul style="list-style-type: none"> • For pipes from DN 15 to 50 mm • PP or PVDF
Iron Strap-on saddles 	<ul style="list-style-type: none"> • 2 to 4 inch, cut 1-7/16 inch hole in pipe • Over 4 inch, cut 2-1/8 inch hole in pipe • Special order 12 in. to 36 in. 		

515/8510-XX Ordering Information		2536/8512-XX Ordering Information		Product Description
Part No.	Code	Part No.	Code	
P51530-P0.....	198 801 620	3-2536-P0.....	198 840 143	Sensor, Polypropylene, Titanium Rotor Pin, PVDF Rotor (black), 1/2 to 4 Inch
P51530-P1.....	198 801 621	3-2536-P1.....	198 840 144	Sensor, Polypropylene, Titanium Rotor Pin, PVDF Rotor (black) 5 to 8 Inch
P51530-P2.....	198 801 622	3-2536-P2.....	198 840 145	Sensor, Polypropylene, Titanium Rotor Pin, PVDF Rotor (black) 10 to 36 Inch
P51530-P3.....	198 840 310	3-2536-P3.....	159 000 758	Sensor, Wet-Tap, Polypropylene, Titanium Rotor Pin, PVDF Rotor (black), 1/2 to 4 Inch
P51530-P4.....	198 840 311	3-2536-P4.....	159 000 759	Sensor, Wet-Tap, Polypropylene, Titanium Rotor Pin, PVDF Rotor (black) 5 to 8 Inch
P51530-P5.....	198 840 312	3-2536-P5.....	159 000 760	Sensor, Wet-Tap, Polypropylene, Titanium Rotor Pin, PVDF Rotor (black) 10 to 36 Inch
P51530-V0.....	198 801 623	3-2536-V0.....	198 840 146	Sensor, PVDF (natural), Hastelloy Rotor Pin, PVDF Rotor (natural), 1/2 to 4 Inch
P51530-V1.....	198 801 624	3-2536-V1.....	198 840 147	Sensor, PVDF (natural), Hastelloy Rotor Pin, PVDF Rotor (natural), 5 to 8 Inch
P51530-V2.....	198 801 625	N/A	N/A	Sensor, PVDF (natural), Hastelloy Rotor Pin, PVDF Rotor (natural), 10 to 36 Inch
P51530-T0.....	198 801 663	3-2536-T0.....	198 840 149	Sensor, PVDF (natural), PVDF (nat.) Rotor Pin, PVDF Rotor (nat.), 1/2 to 4 Inch
P51530-T1.....	198 801 664	N/A	N/A	Sensor, PVDF (natural), PVDF (nat.) Rotor Pin, PVDF Rotor (nat.), 5 to 8 Inch
3-8510-P0.....	198 864 504	3-8512-P0.....	198 864 513	Sensor, Integral, PP, Titanium Rotor Pin, PVDF Rotor (black), 1/2 to 4 Inch
3-8510-P1.....	198 864 505	3-8512-P1.....	198 864 514	Sensor, Integral, PP, Titanium Rotor Pin, PVDF Rotor (black) 5 to 8 Inch
3-8510-T0.....	159 000 622	3-8512-T0.....	198 864 518	Sensor, Integral, PVDF (nat.), Hastelloy Rotor Pin, PVDF Rotor (nat.), 1/2 to 4 In.
3-8510-V0.....	198 864 506	3-8512-V0.....	198 864 516	Sensor, Integral, PVDF (nat.), PVDF (nat.) Rotor Pin, PVDF Rotor (nat.), 1/2 to 4 In.
3-3519/515-P3..	159 000 819	3-3519/2536-P3	159 000 822	Sensor & Wet-Tap Assy., PP, Titanium Rotor Pin, PVDF Rotor (black), 1/2 to 4 In.
3-3519/515-P4..	159 000 820	3-3519/2536-P4	159 000 823	Sensor & Wet-Tap Assy., PP, Titanium Rotor Pin, PVDF Rotor (black), 5 to 8 In.
3-3519/515-P5..	159 000 821	3-3519/2536-P5	159 000 824	Sensor & Wet-Tap Assy., PP, Titanium Rotor Pin, PVDF Rotor (black), 10 to 36 In.
Accessories				
M1538-2.....	198 801 181	3-2536.320-1	198 820 052	Rotor, PVDF Black
P51547-3.....	159 000 474	3-2536.320-2	159 000 272	Rotor, PVDF Natural
M1538-4.....	198 820 018	3-2536.320-3	159 000 273	Rotor, Tefzel®
P51550-3.....	198 820 043	3-2536.321	198 820 054	Rotor and Pin, PVDF Natural
3-0515.322-1	198 820 059	3-2536.322-1	198 820 056	Sleeved Rotor, PVDF Black
3-0515.322-2	198 820 060	3-2536.322-2	198 820 057	Sleeved Rotor, PVDF Natural
3-0515.322-3	198 820 017	3-2536.322-3	198 820 058	Sleeved Rotor, Tefzel®
M1546-1.....	198 801 182	M1546-1.....	198 801 182	Rotor Pin, Titanium
M1546-2.....	198 801 183	M1546-2.....	198 801 183	Rotor Pin, Hastelloy-C
M1546-3.....	198 820 014	M1546-3.....	198 820 014	Rotor Pin, Tantalum
M1546-4.....	198 820 015	M1546-4.....	198 820 015	Rotor Pin, Stainless Steel
P51545.....	198 820 016	P51545.....	198 820 016	Rotor Pin, Ceramic
1220-0021.....	198 801 186	1220-0021.....	198 801 186	O-Ring, FPM
1224-0021.....	198 820 006	1224-0021.....	198 820 006	O-Ring, EPDM
1228-0021.....	198 820 007	1228-0021.....	198 820 007	O-Ring, FFKM
P31536.....	198 840 201	P31536.....	198 840 201	Sensor Plug, Polypro
P31536-1.....	198 840 202	P31536-1.....	198 840 202	Sensor Plug, PVDF Metric
P31536-2.....	159 000 649	P31536-2.....	159 000 649	Sensor Plug, PVDF
P31542.....	198 801 630	P31542.....	198 801 630	Sensor Cap, Red (for use w/515)
----	----	P31542-3.....	159 000 464	Sensor Cap, Blue (for use w/2536)
P31934.....	159 000 466	P31934.....	159 000 466	Conduit Cap
P51589.....	159 000 476	P51589.....	159 000 476	Conduit Adapter Kit
5523-0222.....	159 000 392	5523-0222.....	159 000 392	Cable (per foot), 2 cond. w/shield, 22 AWG
6400-9001.....	159 001 466	----	----	Intrinsic Safety barrier for 515 use ONLY (2 req'd per installation)

+GF+

Georg Fischer Signet LLC, 3401 Aerojet Avenue, El Monte, CA 91731-2882 U.S.A. • Tel. (626) 571-2770 • Fax (626) 573-2057
For Worldwide Sales and Service, visit our website: www.gfsignet.com • Or call (in the U.S.): (800) 854-4090

