

<p>Order Code</p> <p style="text-align: center;"> Gear Set Drive Mount </p> <table border="1" style="width:100%; border-collapse: collapse; text-align: center;"> <tr> <td style="width: 12.5%;">Base Code</td> <td style="width: 12.5%;"></td> <td style="width: 12.5%;"></td> <td style="width: 12.5%;"></td> <td style="width: 12.5%;"></td> <td style="width: 12.5%;"></td> <td style="width: 12.5%;"></td> <td style="width: 12.5%;"></td> <td style="width: 12.5%;"></td> <td style="width: 12.5%;"></td> <td style="width: 12.5%;"></td> </tr> <tr> <td>G</td> <td>J</td> <td></td> <td></td> <td></td> <td></td> <td></td> <td></td> <td></td> <td></td> <td></td> </tr> <tr> <td>1</td> <td>2</td> <td>3</td> <td>4</td> <td>5</td> <td>6</td> <td>7</td> <td>8</td> <td colspan="3"></td> </tr> <tr> <td colspan="3">Model</td> <td colspan="3">Wetted Materials</td> <td colspan="5">Options</td> </tr> </table> <p style="font-size: small;">O/C: Pump S/K: Service Kit</p>	Base Code											G	J										1	2	3	4	5	6	7	8				Model			Wetted Materials			Options					<p>Pump Construction</p> <p>Magnetic Drive Gear Pump Cavity Style Two Helical, Shafted Gears/DP24 Sleeve Bushings Gasket Seals (Qty 2) PTFE Ravel or O-Ring Seal (Qty 1)</p>
Base Code																																													
G	J																																												
1	2	3	4	5	6	7	8																																						
Model			Wetted Materials			Options																																							

Base Code Select a code character for each numbered position to configure the product.

1	Code	Product Type	Specifications	Notes
	G	Gear Pump		
2	J	Product Series	<i>Max System Pressure (MAWP)</i> Series 120 21 Bar (300 psi)	<i>Ports</i> 1/8-27 (F) NPT Side Ports
3	-	Design Modifier		
		Standard Design		
4		Gear Set (Width/N°Gears/Pitch)	<i>Displacement</i> N21 0.175/2/24 N23 0.350/2/24 N25 0.500/2/24	<i>Max Differential Pressure</i> 5.6 Bar (80 psi) 5.6 Bar (80 psi) 5.6 Bar (80 psi)
				<i>Driven Magnet (Standard)</i> Ferrite Ferrite Ferrite
5		Gear Material		<i>Temp Range</i>
	F	PTFE	3.5 Bar (50 psi)	-46/99°C (-50/210°F)
	P	PPS (carbon fiber/ptfe)	5.2 Bar (75 psi)	-46/121°C (-50/250°F) 1
	J	PEEK (carbon fiber/ptfe)	5.6 Bar (80 psi)	-46/121°C (-50/250°F) 1
6		Static Seals		<i>Temp Range</i>
	F1	PTFE Gasket (.004) 5369		-46/54°C (-50/130°F) 2
	F2	PTFE Gasket (.005) 3613		43/77°C (110/170°F) 2
	F3	PTFE Gasket (.006) 4188		71/99°C (160/210°F) 2
7		Base Materials		
	S	SS316		
	D	Alloy 20		
	T	Titanium		
	C	Hast C-276®		
	B	Hast B-2®		
8		Drive Mount	<i>Max System Pressure (MAWP)</i>	<i>Weight (Pumphead)</i>
	A	MP Housing	21 Bar (300 psi)	0.34 kg (0.75 lbs)
	B	MP Plate	21 Bar (300 psi)	0.34 kg (0.75 lbs)
	C	MP Step Cup (2 oz-in)	21 Bar (300 psi)	0.34 kg (0.75 lbs) 3
	G	MP Integral Series® (SS316)	21 Bar(300 psi) SS316	0.45 kg (1.0 lbs) 4
	E	NEMA 56C	21 Bar (300 psi)	1.2 kg (2.6 lbs) 5
	K	NEMA 143/145TC	21 Bar (300 psi)	1.2 kg (2.6 lbs) 5
	2	IEC 56-B14	21 Bar (300 psi)	1.2 kg (2.6 lbs) 6
	3	IEC 63-B5	21 Bar (300 psi)	1.2 kg (2.6 lbs) 5
	4	IEC 63-B14	21 Bar (300 psi)	1.2 kg (2.6 lbs) 5
	5	IEC 71-B5	21 Bar (300 psi)	1.2 kg (2.6 lbs) 5
	6	IEC 71-B14	21 Bar (300 psi)	1.2 kg (2.6 lbs) 5

ACTUAL PERFORMANCE MAY VARY - Specifications are subject to change without notice. When multiple specs are noted, the most conservative value applies.

USA: Micropump, Inc., A Unit of IDEX Corporation • Phone 360.253.2008 • Fax 360.253.2401

UK: Micropump, Ltd., A Subsidiary of Micropump, Inc. • Phone +44 (1480) 356900 • Fax +44 (1480) 356920

info@micropump.com

www.micropump.com

GJ000S.2

Page 1 of 2

Order Code <table border="1" style="width:100%; border-collapse: collapse;"> <tr> <td style="width:12.5%;">Base Code</td> <td style="width:12.5%;"></td> <td style="width:12.5%;"></td> <td style="width:12.5%;"></td> <td style="width:12.5%;"></td> <td style="width:12.5%;"></td> <td style="width:12.5%;"></td> <td style="width:12.5%;"></td> </tr> <tr> <td style="text-align:center">G</td> <td style="text-align:center">J</td> <td></td> <td></td> <td></td> <td></td> <td></td> <td></td> </tr> <tr> <td style="text-align:center">1</td> <td style="text-align:center">2</td> <td style="text-align:center">3</td> <td style="text-align:center">4</td> <td style="text-align:center">5</td> <td style="text-align:center">6</td> <td style="text-align:center">7</td> <td style="text-align:center">8</td> </tr> <tr> <td colspan="3" style="text-align:center">Model</td> <td colspan="3" style="text-align:center">Wetted Materials</td> <td colspan="2" style="text-align:center">Options</td> </tr> </table>								Base Code								G	J							1	2	3	4	5	6	7	8	Model			Wetted Materials			Options		Pump Construction Magnetic Drive Gear Pump Cavity Style Two Helical, Shafted Gears/DP24 Sleeve Bushings Gasket Seals (Qty 2) PTFE Ravel or O-Ring Seal (Qty 1)	
Base Code																																									
G	J																																								
1	2	3	4	5	6	7	8																																		
Model			Wetted Materials			Options																																			



Options Add Option codes after the Base Code to modify features or enhance the product.

Bypass (PC11)		<i>Optional Internal Bypass</i>	
B1	Internal Bypass (SS316)	Preset to 3 Bar (G drive to 5.4)	7
Driven Magnet (PC12)			
M1	SmCo Driven (Segments)		8
Driving Magnet (PC13)			
N1	SmCo Driving (Segments)		8
N3	NdFeB Driving (Ring)		8
Bushings (PC15)			
D1	Carbon Bushing(s)		8
Ports/Fittings (PC17)		<i>Ports</i>	
F5	Tri-Clamp (TC25) Fittings	1/2" 316L SS Ferrule	
Port Orientation (PC18)		<i>Ports</i>	
Q1	Deck Ports	1/8-27 (F) NPT Deck Ports	

Notes

- 1 Select appropriate gaskets for higher temperatures (PC06).
- 2 Application details required for temperatures > 54C (130F) before order entry.
- 3 Available only in O/C GJ-N21.FFS.C (no bypass).
- 4 Integral Series® SS316 only. Consult factory for other materials.
- 5 "A" mount aluminum adapter, packaged separately. Includes magnet hub.
- 6 "A" mount plastic adapter, packaged separately. Includes magnet hub.
- 7 Available in SS316 only.
- 8 Application details required before order entry.

ACTUAL PERFORMANCE MAY VARY - Specifications are subject to change without notice. When multiple specs are noted, the most conservative value applies.

USA: Micropump, Inc., A Unit of IDEX Corporation • Phone 360.253.2008 • Fax 360.253.2401

UK: Micropump, Ltd., A Subsidiary of Micropump, Inc. • Phone +44 (1480) 356900 • Fax +44 (1480) 356920

info@micropump.com

www.micropump.com

GJ000S.2

Page 2 of 2

Printed 30-May-01

Order Code				Pump Construction			
Base Code		Gear Set		Drive Mount		Options	
G	J	-	N21				
1	2	3	4	5	6	7	8
Model			Wetted Materials			O/C: Pump S/K: Service Kit	
Magnetic Drive Gear Pump Cavity Style Two Helical, Shafted Gears/DP24 Sleeve Bushings Gasket Seals (Qty 2) PTFE Bevel or O-Ring Seal (Qty 1)							



Performance

GJ-N21

Water @ 1 CP

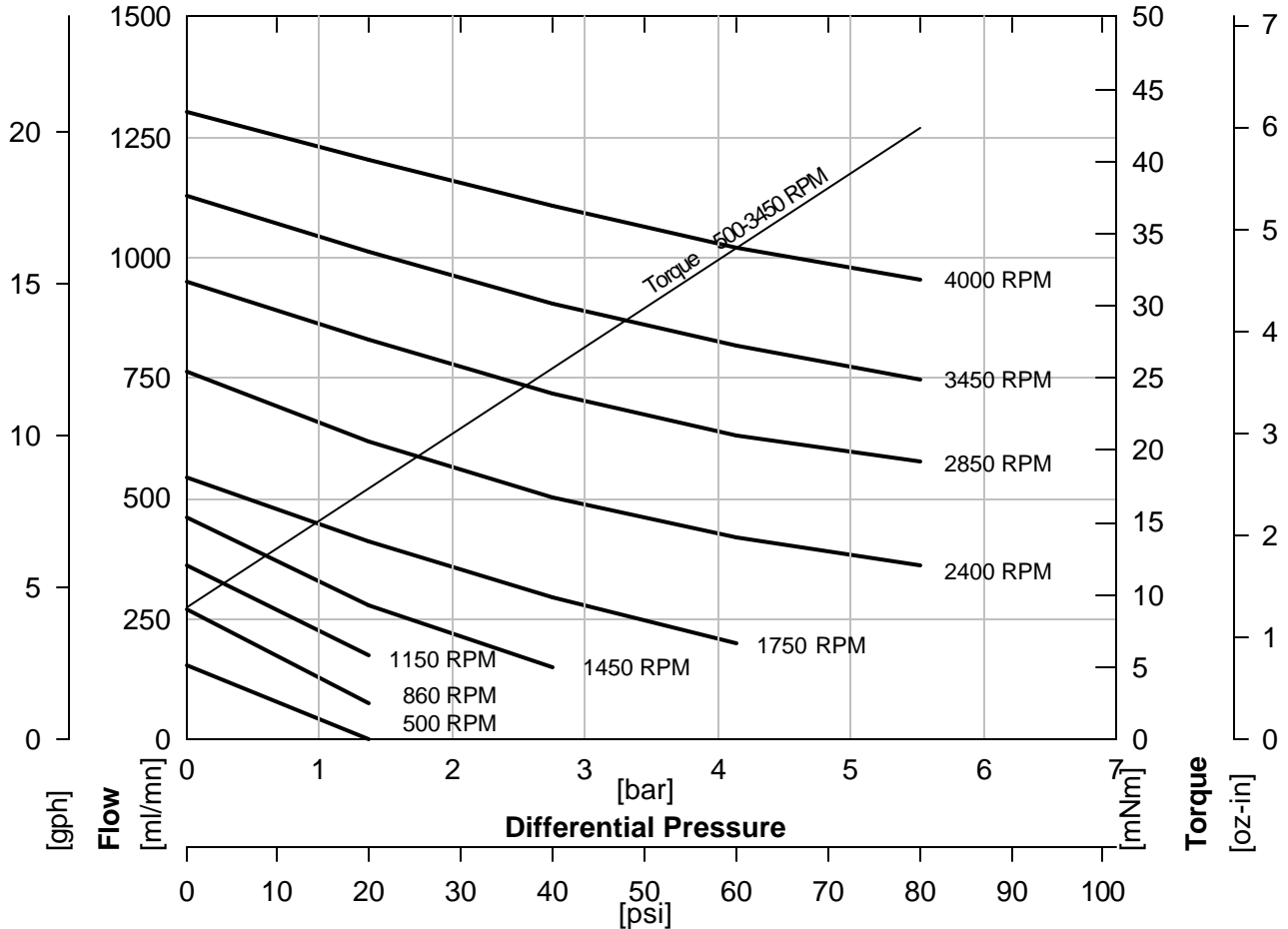

ACTUAL PERFORMANCE MAY VARY - Specifications are subject to change without notice. When multiple specs are noted, the most conservative value applies.

USA: Micropump, Inc., A Unit of IDEX Corporation • Phone 360.253.2008 • Fax 360.253.2401

UK: Micropump, Ltd., A Subsidiary of Micropump, Inc. • Phone +44 (1480) 356900 • Fax +44 (1480) 356920

info@micropump.com

www.micropump.com

GJ100 Rev A

Page 1

Printed 30-May-01

Order Code				Pump Construction			
Base Code		Gear Set		Drive Mount		Options	
G	J	-	N21	●	●	●	●
1	2	3	4	5	6	7	8
Model			Wetted Materials			O/C: Pump S/K: Service Kit	
Magnetic Drive Gear Pump Cavity Style Two Helical, Shafted Gears/DP24 Sleeve Bushings Gasket Seals (Qty 2) PTFE Bevel or O-Ring Seal (Qty 1)							



Performance-High Viscosity

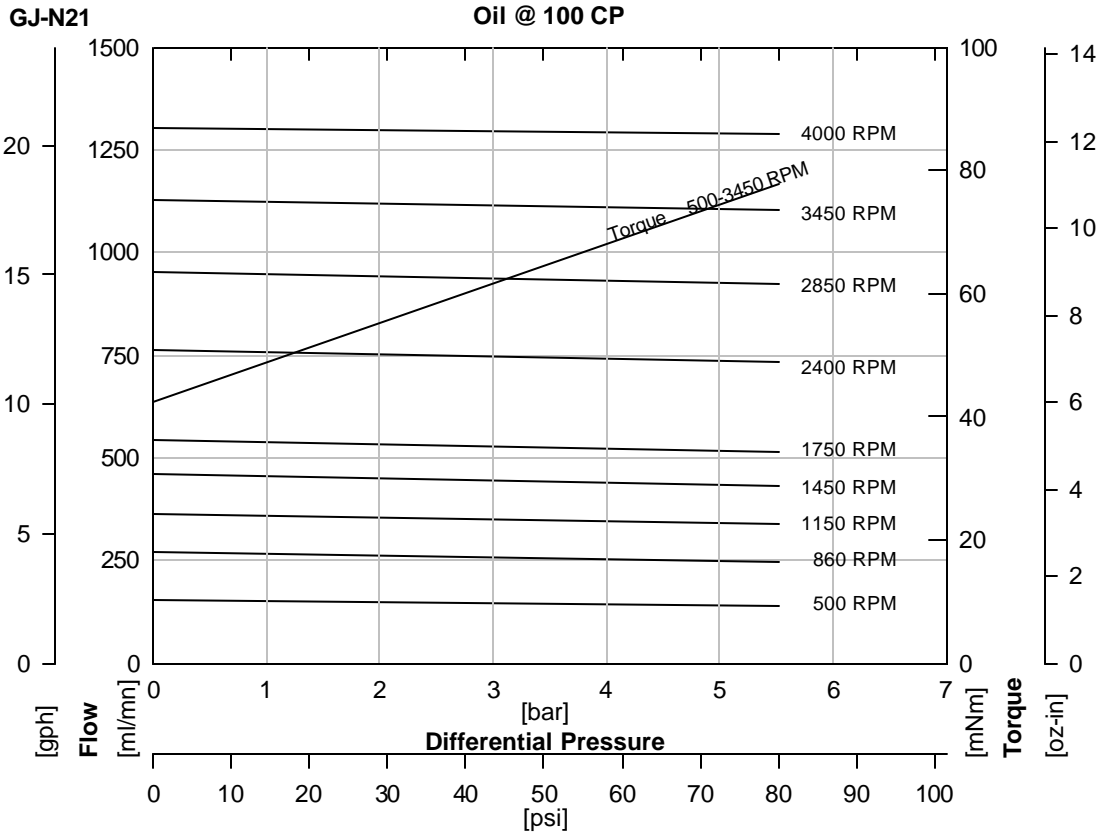

$$\text{Watts} = \frac{\text{Torque [mNm]} \times \text{Speed [RPM]}}{9555}$$

$$\text{HP} = \frac{\text{Torque [oz-in]} \times \text{Speed [RPM]}}{1.008 \times 10^6}$$

To calculate torque, multiply correction factor by torque from viscosity curve above.

Torque Correction Factors: For Higher Viscosity Liquids				
Viscosity [cp]		1	100	1500
Max Speed [RPM]		10000	3450	860
[Bar]	[psi]			
0.3	5	0.2	1	2.3
1.4	20	0.3	1	2.1
2.8	40	0.4	1	1.9
4.1	60	0.5	1	1.8
5.5	80	0.5	1	1.6

Magnet Decouple Torque			
Driven Magnet	Driving Hub	Torque [mNm]	Torque [oz.in]
Ferrite	Ferrite*	113	16
Ferrite	Ferrite**	134	19
Ferrite	SmCo	254	36
SmCo	SmCo	636	90
Ferrite	NdFeB	304	43
SmCo	NdFeB	932	132

ACTUAL PERFORMANCE MAY VARY - Specifications are subject to change without notice. When multiple specs are noted, the most conservative value applies.

USA: Micropump, Inc., A Unit of IDEX Corporation • Phone 360.253.2008 • Fax 360.253.2401

UK: Micropump, Ltd., A Subsidiary of Micropump, Inc. • Phone +44 (1480) 356900 • Fax +44 (1480) 356920

info@micropump.com

www.micropump.com

Order Code				Pump Construction				
Base Code		Gear Set		Drive Mount		Options		
G	J	-	N21	•	•	O/C: Pump S/K: Service Kit		
1	2	3	4	5	6	7	8	
Model			Wetted Materials					

Pump Construction
 Magnetic Drive Gear Pump
 Cavity Style
 Two Helical, Shafted Gears/DP24
 Sleeve Bushings
 Gasket Seals (Qty 2)
 PTFE Bevel or O-Ring Seal (Qty 1)



Specification

	SI	US
Displacement	0.316 ml/rev	0.08 gal/1000*rev
Max Flow (4 Pole Speed)	460 ml/mn 1450 RPM (50Hz)	8.9 gal/hr 1750 RPM (60Hz)
Max Flow (2 Pole Speed)	910 ml/mn 2850 RPM (50Hz)	18 gal/hr 3450 RPM (60Hz)
Max Differential Pressure	1 5.6 Bar	80 psi
Max System Pressure (MAWP)	21 Bar	300 psi
NIPR (Absolute)	180 mBar	2.5 psia
Wet Lift (Typical)	2 51 cm.H2O (1450 RPM)	24 in.H2O (1750 RPM)
Temp Range	3 See Gear Material	See Gear Material
Viscosity Range	4 0.2 to 1500 cp	0.2 to 1500 cp
Max Speed	10,000 RPM	10,000 RPM
Rotation (Facing Motor Shaft)	CW	CW
Weight (Pumphead)	0.45 kg	1.0 lbs
Dimensions (LxWxH)	See Drawing	See Drawing
Ports	1/8-27 (F) NPT Side Ports	1/8-27 (F) NPT Side Ports
Driven Magnet (Standard)	Ferrite	Ferrite
Optional Internal Bypass	Preset to 3 Bar (G drive to 5.4 bar)	Preset to 45 psi (G drive to 80 psi)

Notes

- 1 See Product Options. Max pressure depends on gear material.
- 2 Priming ability varies with operating conditions.
- 3 See Product Options for specific temp limits.
- 4 See Performance-High Viscosity for viscosity limits.

ACTUAL PERFORMANCE MAY VARY - Specifications are subject to change without notice. When multiple specs are noted, the most conservative value applies.

USA: Micropump, Inc., A Unit of IDEX Corporation • Phone 360.253.2008 • Fax 360.253.2401

UK: Micropump, Ltd., A Subsidiary of Micropump, Inc. • Phone +44 (1480) 356900 • Fax +44 (1480) 356920

info@micropump.com

www.micropump.com

GJ100 Rev A

Page 3

Printed 30-May-01

Order Code				Pump Construction			
Base Code		Gear Set		Drive Mount		Options	
G	J	-	N23				
1	2	3	4	5	6	7	8
Model			Wetted Materials			O/C: Pump S/K: Service Kit	
Magnetic Drive Gear Pump Cavity Style Two Helical, Shafted Gears/DP24 Sleeve Bushings Gasket Seals (Qty 2) PTFE Bevel or O-Ring Seal (Qty 1)							



Performance

GJ-N23

Water @ 1 CP

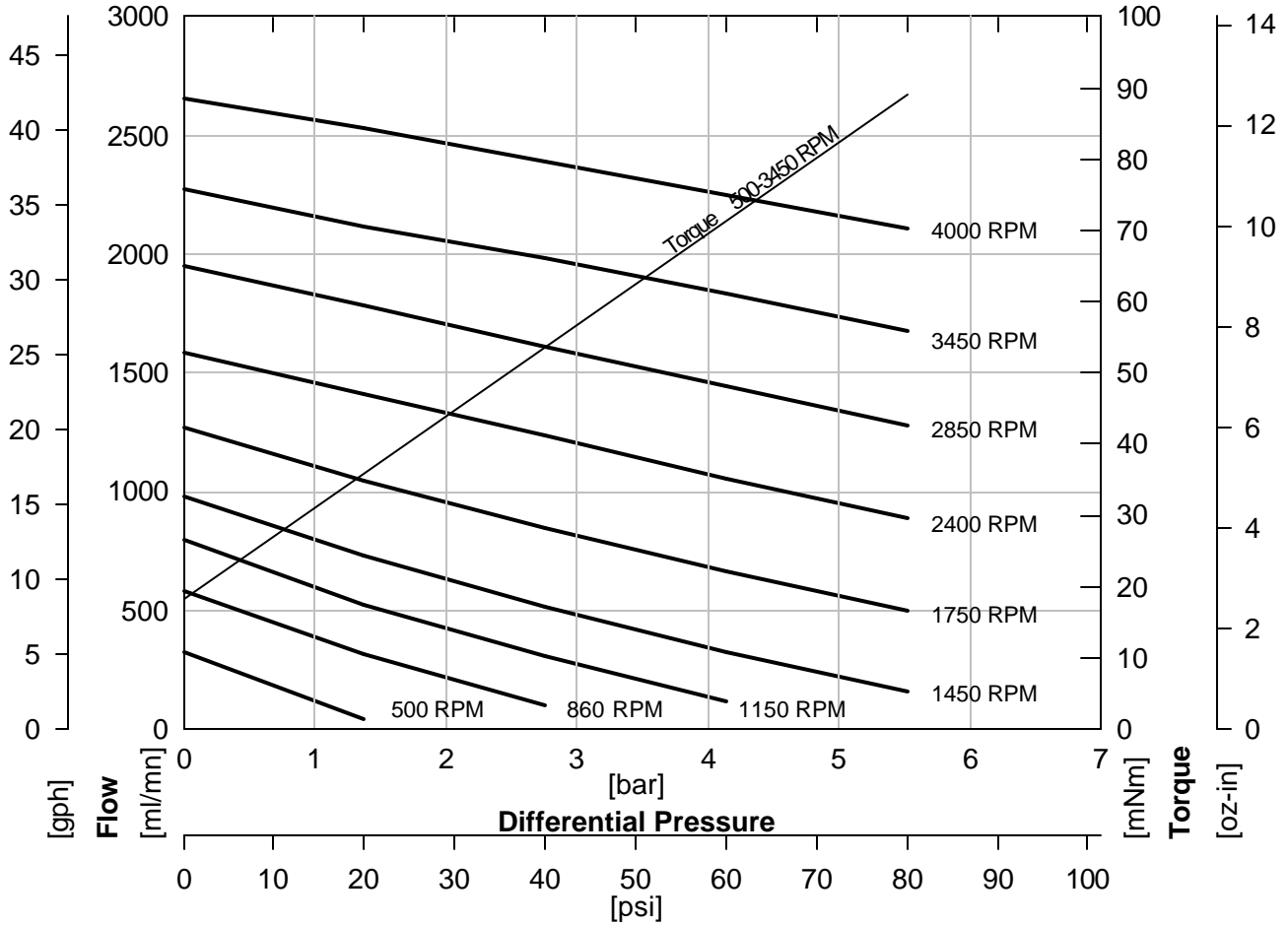

ACTUAL PERFORMANCE MAY VARY - Specifications are subject to change without notice. When multiple specs are noted, the most conservative value applies.

USA: Micropump, Inc., A Unit of IDEX Corporation • Phone 360.253.2008 • Fax 360.253.2401

UK: Micropump, Ltd., A Subsidiary of Micropump, Inc. • Phone +44 (1480) 356900 • Fax +44 (1480) 356920

info@micropump.com

www.micropump.com

GJ300 Rev A

Page 1

Printed 30-May-01

Order Code				Pump Construction				
Base Code		Gear Set		Drive Mount		Options		
G	J	-	N23	•	•	•	•	
1	2	3	4	5	6	7	8	
Model				Wetted Materials				O/C: Pump S/K: Service Kit
Magnetic Drive Gear Pump Cavity Style Two Helical, Shafted Gears/DP24 Sleeve Bushings Gasket Seals (Qty 2) PTFE Bevel or O-Ring Seal (Qty 1)								

Performance-High Viscosity

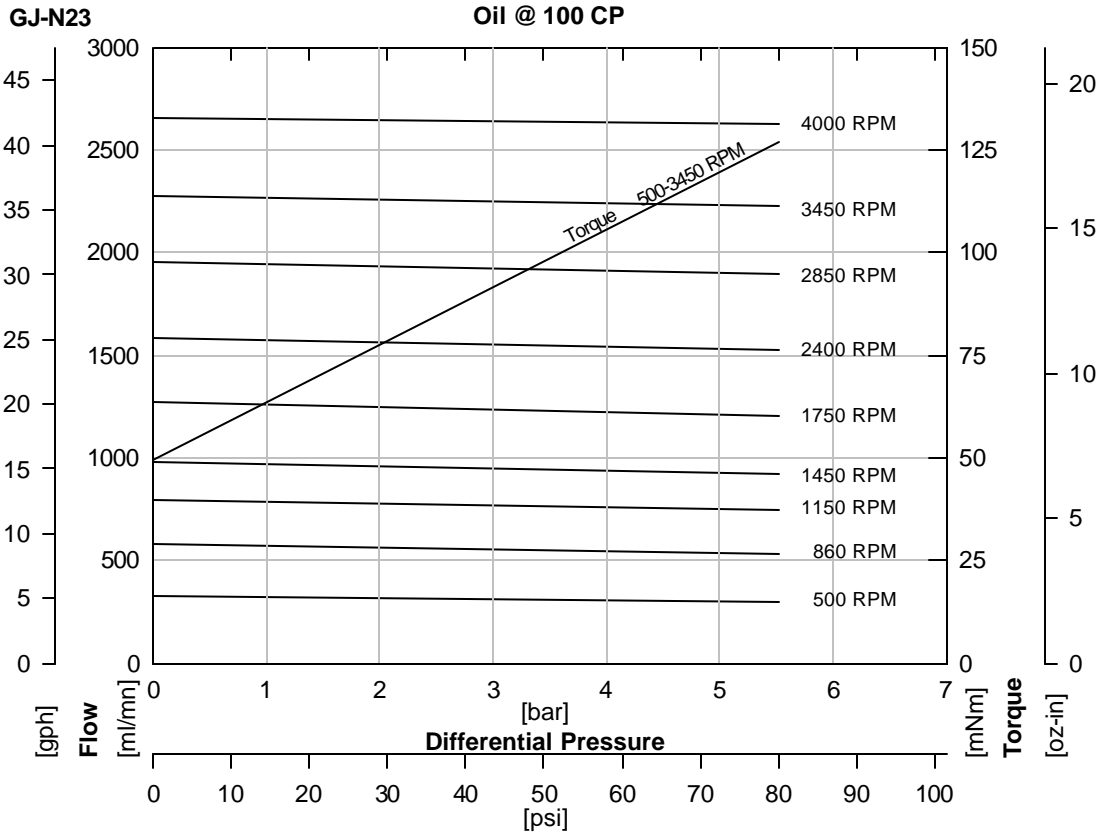

$$\text{Watts} = \frac{\text{Torque [mNm]} \times \text{Speed [RPM]}}{9555}$$

$$\text{HP} = \frac{\text{Torque [oz-in]} \times \text{Speed [RPM]}}{1.008 \times 10^6}$$

To calculate torque, multiply correction factor by torque from viscosity curve above.

Torque Correction Factors: For Higher Viscosity Liquids				
Viscosity [cp]		1	100	1500
Max Speed [RPM]		10000	3450	500
[Bar]	[psi]			
0.3	5	0.4	1	1.7
1.4	20	0.5	1	1.5
2.8	40	0.6	1	1.4
4.1	60	0.7	1	1.3
5.5	80	0.7	1	1.3

Magnet Decouple Torque			
Driven Magnet	Driving Hub	Torque [mNm]	Torque [oz.in]
Ferrite	Ferrite*	113	16
Ferrite	Ferrite**	134	19
Ferrite	SmCo	254	36
SmCo	SmCo	636	90
Ferrite	NdFeB	304	43
SmCo	NdFeB	932	132

ACTUAL PERFORMANCE MAY VARY - Specifications are subject to change without notice. When multiple specs are noted, the most conservative value applies.

USA: Micropump, Inc., A Unit of IDEX Corporation • Phone 360.253.2008 • Fax 360.253.2401

UK: Micropump, Ltd., A Subsidiary of Micropump, Inc. • Phone +44 (1480) 356900 • Fax +44 (1480) 356920

info@micropump.com

www.micropump.com

Order Code				Pump Construction				
Base Code		Gear Set		Drive Mount		Options		
G	J	-	N23	•	•	O/C: Pump S/K: Service Kit		
1	2	3	4	5	6	7	8	
Model			Wetted Materials					

Pump Construction
 Magnetic Drive Gear Pump
 Cavity Style
 Two Helical, Shafted Gears/DP24
 Sleeve Bushings
 Gasket Seals (Qty 2)
 PTFE Bevel or O-Ring Seal (Qty 1)



Specification

	SI	US
Displacement	0.64 ml/rev	0.17 gal/1000*rev
Max Flow (4 Pole Speed)	930 ml/mn 1450 RPM (50Hz)	18 gal/hr 1750 RPM (60Hz)
Max Flow (2 Pole Speed)	1830 ml/mn 2850 RPM (50Hz)	36 gal/hr 3450 RPM (60Hz)
Max Differential Pressure	1 5.6 Bar	80 psi
Max System Pressure (MAWP)	21 Bar	300 psi
NIPR (Absolute)	180 mBar	2.5 psia
Wet Lift (Typical)	2 51 cm.H2O (1450 RPM)	24 in.H2O (1750 RPM)
Temp Range	3 See Gear Material	See Gear Material
Viscosity Range	4 0.2 to 1500 cp	0.2 to 1500 cp
Max Speed	10,000 RPM	10,000 RPM
Rotation (Facing Motor Shaft)	CW	CW
Weight (Pumphead)	0.45 kg	1.0 lbs
Dimensions (LxWxH)	See Drawing	See Drawing
Ports	1/8-27 (F) NPT Side Ports	1/8-27 (F) NPT Side Ports
Driven Magnet (Standard)	Ferrite	Ferrite
Optional Internal Bypass	Preset to 3 Bar (G drive to 5.4 bar)	Preset to 45 psi (G drive to 80 psi)

Notes

- 1 See Product Options. Max pressure depends on gear material.
- 2 Priming ability varies with operating conditions.
- 3 See Product Options for specific temp limits.
- 4 See Performance-High Viscosity for viscosity limits.

ACTUAL PERFORMANCE MAY VARY - Specifications are subject to change without notice. When multiple specs are noted, the most conservative value applies.

USA: Micropump, Inc., A Unit of IDEX Corporation • Phone 360.253.2008 • Fax 360.253.2401

UK: Micropump, Ltd., A Subsidiary of Micropump, Inc. • Phone +44 (1480) 356900 • Fax +44 (1480) 356920

info@micropump.com

www.micropump.com

GJ300 Rev A

Page 3

Printed 30-May-01

Order Code				Pump Construction			
Base Code		Gear Set		Drive Mount		Options	
G	J	-	N25				
1	2	3	4	5	6	7	8
Model			Wetted Materials			O/C: Pump S/K: Service Kit	
Magnetic Drive Gear Pump Cavity Style Two Helical, Shafted Gears/DP24 Sleeve Bushings Gasket Seals (Qty 2) PTFE Bevel or O-Ring Seal (Qty 1)							



Performance

GJ-N25

Water @ 1 CP

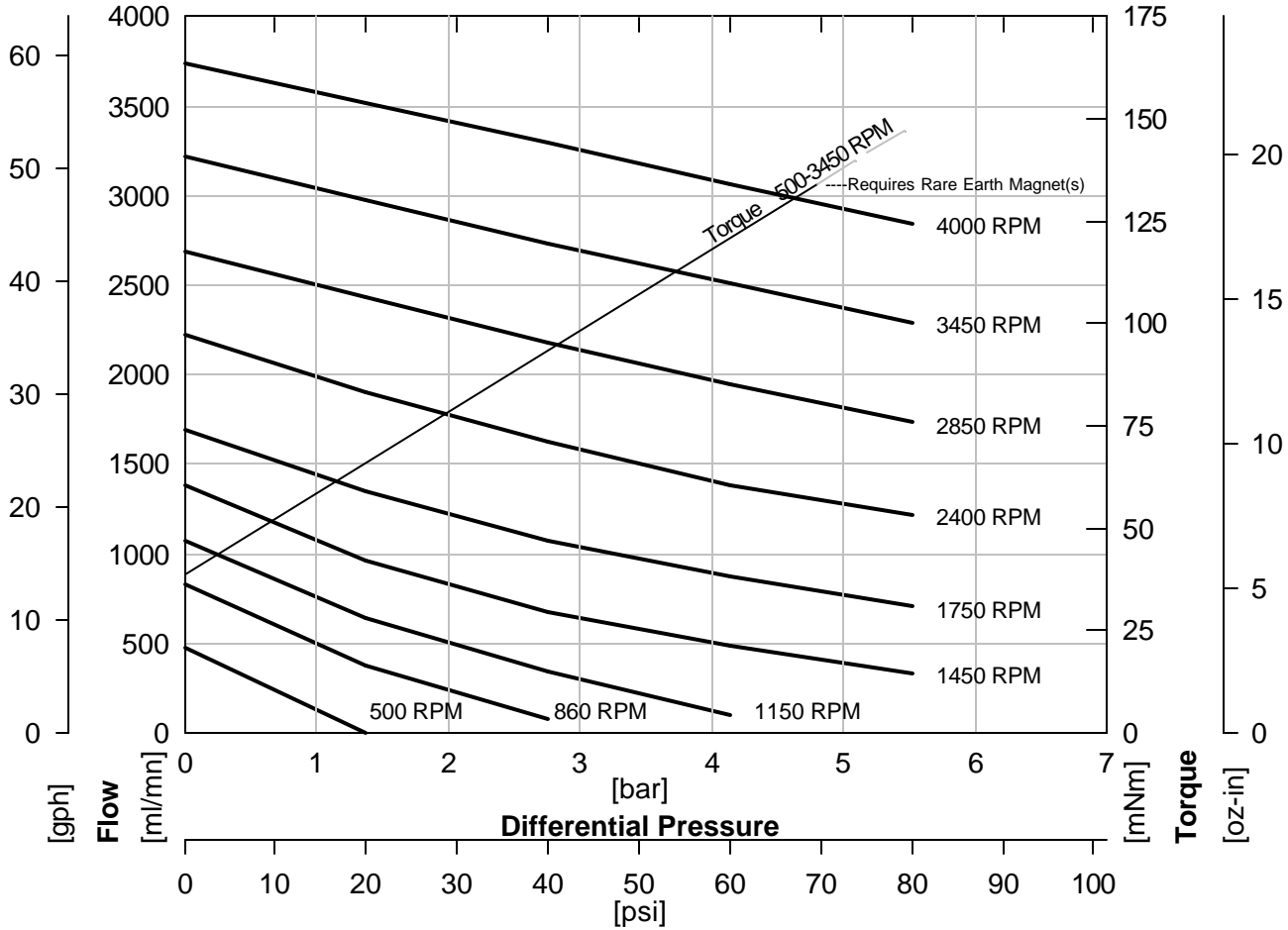

ACTUAL PERFORMANCE MAY VARY - Specifications are subject to change without notice. When multiple specs are noted, the most conservative value applies.

USA: Micropump, Inc., A Unit of IDEX Corporation • Phone 360.253.2008 • Fax 360.253.2401

UK: Micropump, Ltd., A Subsidiary of Micropump, Inc. • Phone +44 (1480) 356900 • Fax +44 (1480) 356920

info@micropump.com

www.micropump.com

GJ500 Rev A

Page 1

Printed 30-May-01

Order Code				Pump Construction				
Base Code		Gear Set		Drive Mount		Options		
G	J	-	N25	5	6	7	8	
1 2 3 4 5 6 7 8		Model		Wetted Materials				Magnetic Drive Gear Pump Cavity Style Two Helical, Shafted Gears/DP24 Sleeve Bushings Gasket Seals (Qty 2) PTFE Bevel or O-Ring Seal (Qty 1)

Performance-High Viscosity

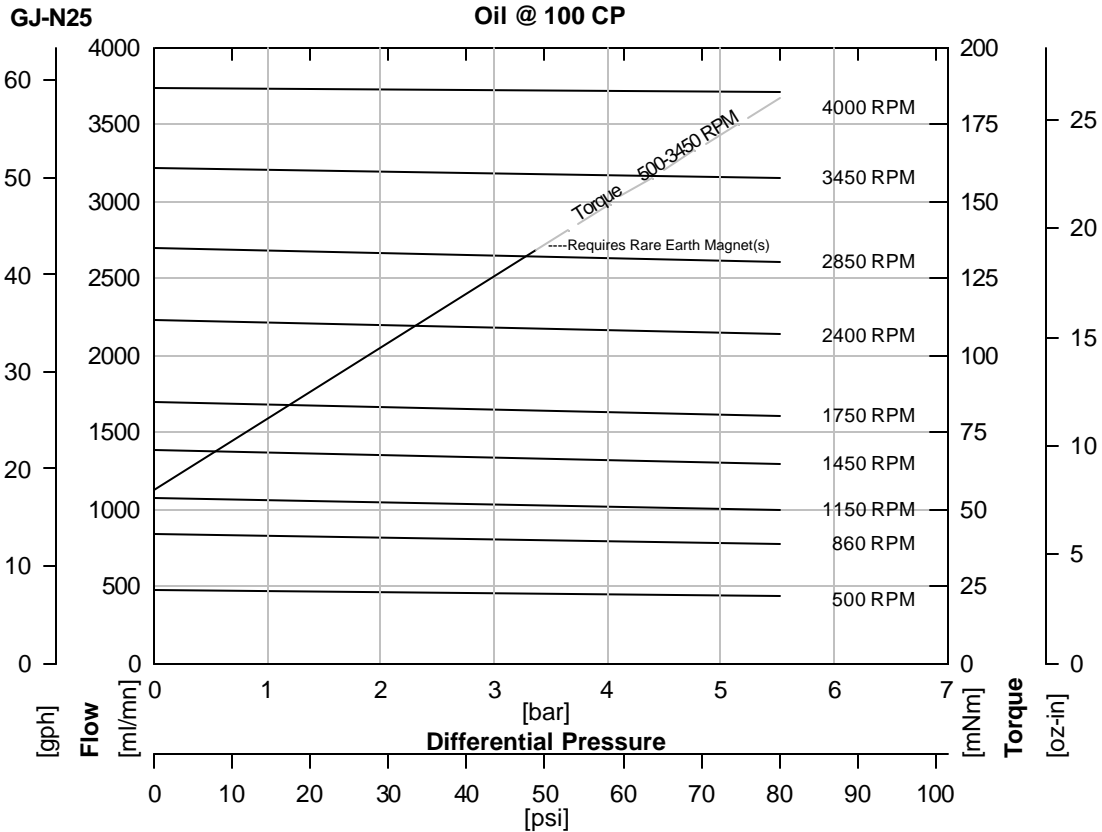

$$\text{Watts} = \frac{\text{Torque [mNm]} \times \text{Speed [RPM]}}{9555}$$

$$\text{HP} = \frac{\text{Torque [oz-in]} \times \text{Speed [RPM]}}{1.008 \times 10^6}$$

To calculate torque, multiply correction factor by torque from viscosity curve above.

Torque Correction Factors: For Higher Viscosity Liquids				
Viscosity [cp]		1	100	1500
Max Speed [RPM]		10000	3450	300
[Bar]	[psi]			
0.3	5	0.7	1	1.3
1.4	20	0.7	1	1.2
2.8	40	0.8	1	1.1
4.1	60	0.8	1	1.1
5.5	80	0.8	1	1.1

Magnet Decouple Torque			
Driven Magnet	Driving Hub	Torque [mNm]	Torque [oz.in]
Ferrite	Ferrite*	113	16
Ferrite	Ferrite**	134	19
Ferrite	SmCo	254	36
SmCo	SmCo	636	90
Ferrite	NdFeB	304	43
SmCo	NdFeB	932	132

ACTUAL PERFORMANCE MAY VARY - Specifications are subject to change without notice. When multiple specs are noted, the most conservative value applies.

USA: Micropump, Inc., A Unit of IDEX Corporation • Phone 360.253.2008 • Fax 360.253.2401

UK: Micropump, Ltd., A Subsidiary of Micropump, Inc. • Phone +44 (1480) 356900 • Fax +44 (1480) 356920

info@micropump.com

www.micropump.com

Order Code				Pump Construction			
Base Code		Gear Set		Drive Mount		Options	
G	J	-	N25	5	7	8	
1 2 3 4 5 6 7 8		Model		Wetted Materials		O/C: Pump S/K: Service Kit	
Magnetic Drive Gear Pump				Cavity Style			
Two Helical, Shafted Gears/DP24				Sleeve Bushings			
Gasket Seals (Qty 2)				PTFE Bevel or O-Ring Seal (Qty 1)			



Specification

	SI	US
Displacement	0.91 ml/rev	0.24 gal/1000*rev
Max Flow (4 Pole Speed)	1320 ml/mn 1450 RPM (50Hz)	26 gal/hr 1750 RPM (60Hz)
Max Flow (2 Pole Speed)	2600 ml/mn 2850 RPM (50Hz)	50 gal/hr 3450 RPM (60Hz)
Max Differential Pressure	1 5.6 Bar	80 psi
Max System Pressure (MAWP)	21 Bar	300 psi
NIPR (Absolute)	180 mBar	2.5 psia
Wet Lift (Typical)	2 51 cm.H2O (1450 RPM)	24 in.H2O (1750 RPM)
Temp Range	3 See Gear Material	See Gear Material
Viscosity Range	4 0.2 to 1500 cp	0.2 to 1500 cp
Max Speed	10,000 RPM	10,000 RPM
Rotation (Facing Motor Shaft)	CW	CW
Weight (Pumphead)	0.45 kg	1.0 lbs
Dimensions (LxWxH)	See Drawing	See Drawing
Ports	1/8-27 (F) NPT Side Ports	1/8-27 (F) NPT Side Ports
Driven Magnet (Standard)	Ferrite	Ferrite
Optional Internal Bypass	Preset to 3 Bar (G drive to 5.4 bar)	Preset to 45 psi (G drive to 80 psi)

Notes

- 1 See Product Options. Max pressure depends on gear material.
- 2 Priming ability varies with operating conditions.
- 3 See Product Options for specific temp limits.
- 4 See Performance-High Viscosity for viscosity limits.

ACTUAL PERFORMANCE MAY VARY - Specifications are subject to change without notice. When multiple specs are noted, the most conservative value applies.

USA: Micropump, Inc., A Unit of IDEX Corporation • Phone 360.253.2008 • Fax 360.253.2401

UK: Micropump, Ltd., A Subsidiary of Micropump, Inc. • Phone +44 (1480) 356900 • Fax +44 (1480) 356920

info@micropump.com

www.micropump.com

GJ500 Rev A

Page 3

Printed 30-May-01

Order Code								Pump Construction	
Base Code		Gear Set		Drive Mount		Options		 <p>Magnetic Drive Gear Pump Cavity Style Two Helical, Shafted Gears/DP24 Sleeve Bushings Gasket Seals (Qty 2) PTFE Bevel or O-Ring Seal (Qty 1)</p>	
G	J	-	N21			A			
1	2	3	4	5	6	7	8		
Model			Wetted Materials			O/C: Pump S/K: Service Kit			

Dimension

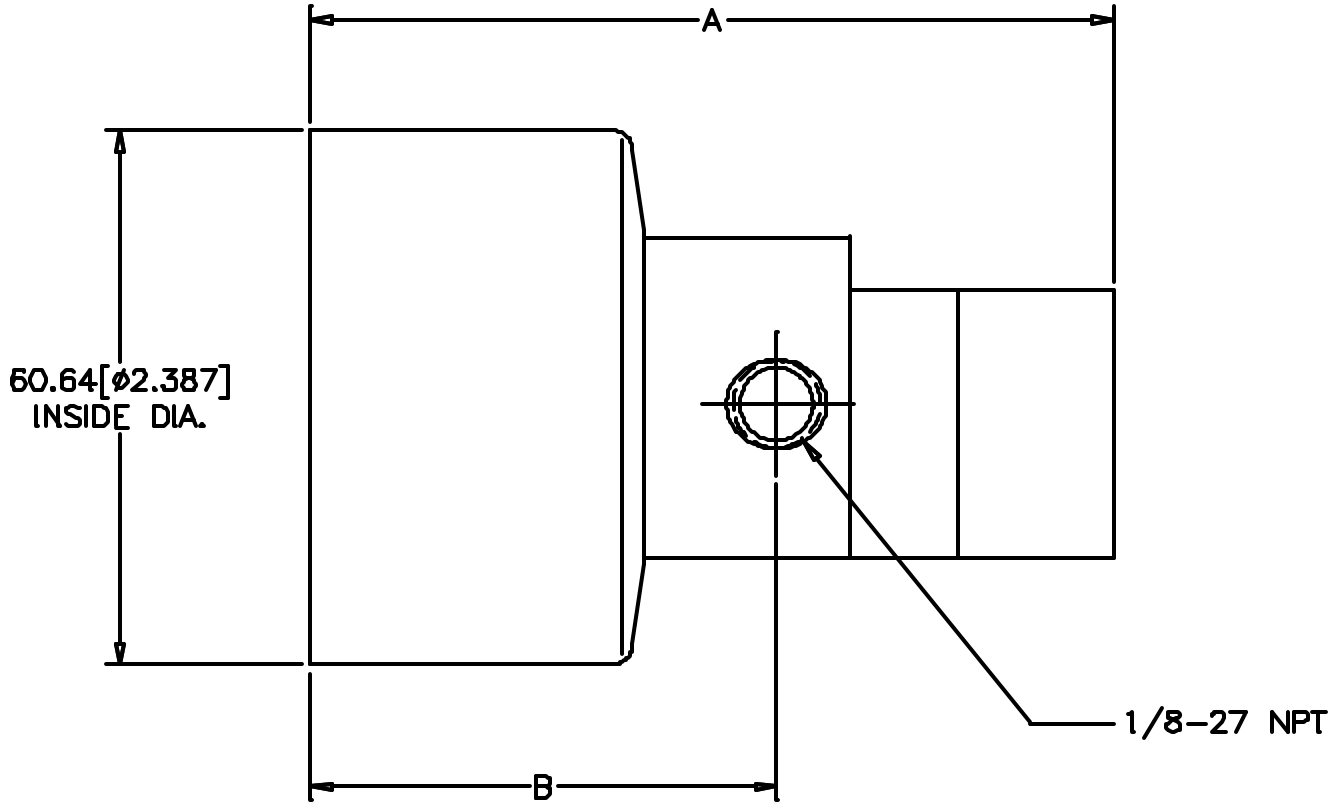

GEAR SET	A (MAX) mm [in]	B mm [in]
N21	86.0 [3.39]	54.6 [2.15]
N23	90.4 [3.56]	54.6 [2.15]
N25	94.4 [3.72]	54.6 [2.15]

NOTES:

1. ALL DIMENSIONS ARE NOMINAL

ACTUAL PERFORMANCE MAY VARY - Specifications are subject to change without notice. When multiple specs are noted, the most conservative value applies.

USA: Micropump, Inc., A Unit of IDEX Corporation • Phone 360.253.2008 • Fax 360.253.2401

UK: Micropump, Ltd., A Subsidiary of Micropump, Inc. • Phone +44 (1480) 356900 • Fax +44 (1480) 356920

info@micropump.com

www.micropump.com

Order Code								Pump Construction	
Base Code		Gear Set		Drive Mount		Options		 <p>Magnetic Drive Gear Pump Cavity Style Two Helical, Shafted Gears/DP24 Sleeve Bushings Gasket Seals (Qty 2) PTFE Bevel or O-Ring Seal (Qty 1)</p>	
G	J	-	N21			E			
1	2	3	4	5	6	7	8		
Model			Wetted Materials			O/C: Pump S/K: Service Kit			

Dimension

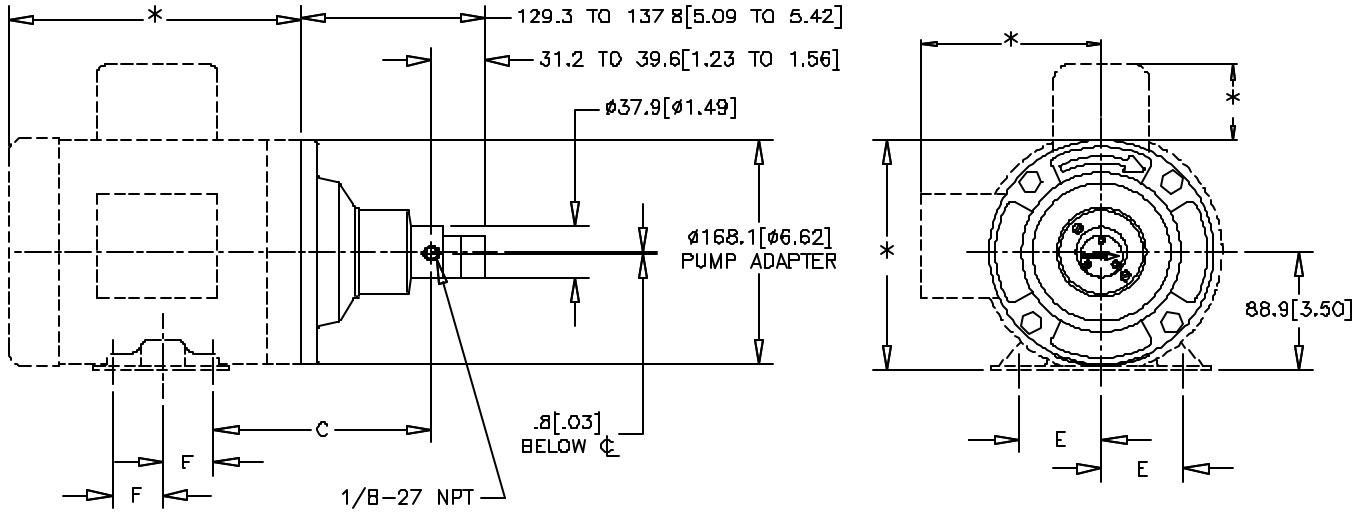

MOUNT	C mm [in]	E mm [in]	F mm [in]
^E NEMA 56C	163.4 [6.43]	61.9 [2.44]	38.1 [1.50]
^K NEMA 143TC	158.5 [6.24]	69.9 [2.75]	50.8 [2.00]
^K NEMA 145TC	158.5 [6.24]	69.9 [2.75]	63.5 [2.50]

NOTES:

- *THESE DIMENSIONS WILL VARY BASED ON MOTOR SELECTION.
- ALL DIMENSIONS ARE NOMINAL.

ACTUAL PERFORMANCE MAY VARY - Specifications are subject to change without notice. When multiple specs are noted, the most conservative value applies.

USA: Micropump, Inc., A Unit of IDEX Corporation • Phone 360.253.2008 • Fax 360.253.2401

UK: Micropump, Ltd., A Subsidiary of Micropump, Inc. • Phone +44 (1480) 356900 • Fax +44 (1480) 356920

info@micropump.com

www.micropump.com

Order Code								Pump Construction	
Base Code		Gear Set		Drive Mount		Options		 <p>Magnetic Drive Gear Pump Cavity Style Two Helical, Shafted Gears/DP24 Sleeve Bushings Gasket Seals (Qty 2) PTFE Bevel or O-Ring Seal (Qty 1)</p>	
G	J	-	N21			2			
1	2	3	4	5	6	7	8		
Model			Wetted Materials			O/C: Pump S/K: Service Kit			

Dimension

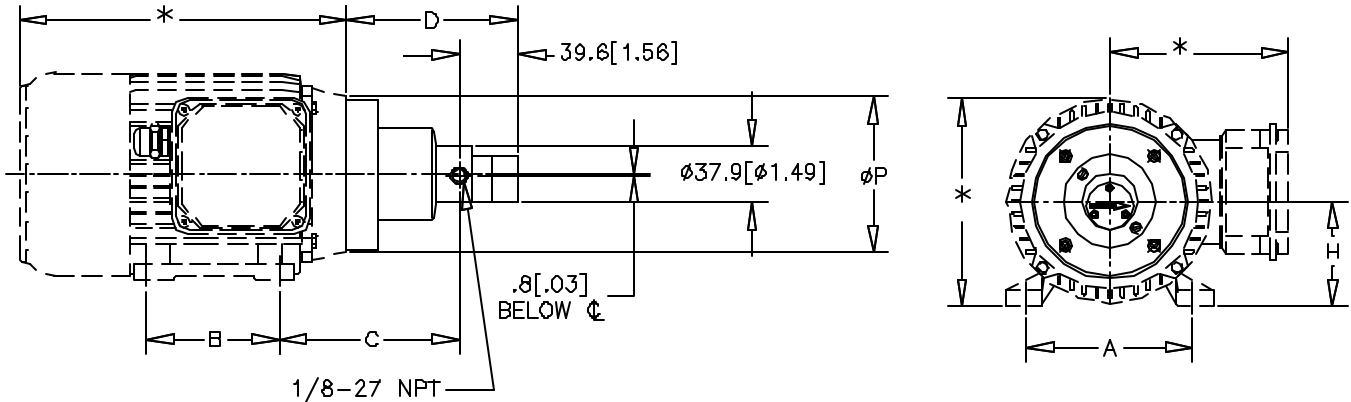

MOUNT	A mm [in]	B mm [in]	C mm [in]	D mm [in]	H mm [in]	P mm [in]
² IEC56B14B3	90 [3.54]	71 [2.80]	99.2 [3.90]	94.5 [3.72] TO 102.8 [4.05]	56 [2.20]	80 [3.15]
⁴ IEC63B14B3	100 [3.94]	80 [3.15]	108.8 [4.28]	100.1 [3.94] TO 108.5 [4.27]	63 [2.48]	90 [3.54]
⁶ IEC71B14B3	112 [4.41]	90 [3.54]	120.8 [4.76]	107.1 [4.22] TO 115.5 [4.55]	71 [2.80]	105 [4.13]

NOTES:

- *THESE DIMENSIONS WILL VARY BASED ON MOTOR SELECTION.
- ALL DIMENSIONS ARE NOMINAL.

ACTUAL PERFORMANCE MAY VARY - Specifications are subject to change without notice. When multiple specs are noted, the most conservative value applies.

USA: Micropump, Inc., A Unit of IDEX Corporation • Phone 360.253.2008 • Fax 360.253.2401

UK: Micropump, Ltd., A Subsidiary of Micropump, Inc. • Phone +44 (1480) 356900 • Fax +44 (1480) 356920

info@micropump.com

www.micropump.com

Order Code				Pump Construction			
Base Code		Gear Set		Drive Mount		Options	
G	J	-	N21	•	•	•	•
1	2	3	4	5	6	7	8
Model			Wetted Materials				O/C: Pump S/K: Service Kit
Magnetic Drive Gear Pump Cavity Style Two Helical, Shafted Gears/DP24 Sleeve Bushings Gasket Seals (Qty 2) PTFE Bevel or O-Ring Seal (Qty 1)							



Dimension

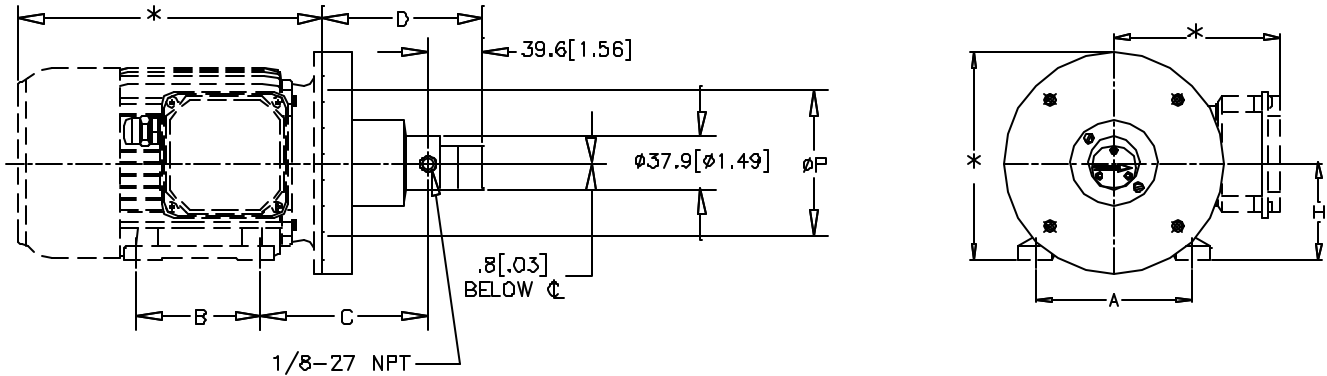

MOUNT	A mm [in]	B mm [in]	C mm [in]	D mm [in]	H mm [in]	P mm [in]
³ IEC63B5B3	100 [3.94]	80 [3.15]	108.8[4.28]	100.1[3.94] TO 108.5[4.27]	63 [2.48]	140 [5.51]
⁵ IEC71B5B3	112 [4.41]	90 [3.54]	120.8[4.76]	107.1[4.22] TO 115.5[4.55]	71 [2.80]	160 [6.30]

NOTES:

1. *THESE DIMENSIONS WILL VARY BASED ON MOTOR SELECTION.
2. ALL DIMENSIONS ARE NOMINAL.

ACTUAL PERFORMANCE MAY VARY - Specifications are subject to change without notice. When multiple specs are noted, the most conservative value applies.

USA: Micropump, Inc., A Unit of IDEX Corporation • Phone 360.253.2008 • Fax 360.253.2401

UK: Micropump, Ltd., A Subsidiary of Micropump, Inc. • Phone +44 (1480) 356900 • Fax +44 (1480) 356920

info@micropump.com

www.micropump.com

GJ106 Rev A
Dimensions 1