

FURUNO

OPERATOR'S MANUAL

DOPPLER SPEEDLOG

MODEL DS-50



FURUNO ELECTRIC CO., LTD.
NISHINOMIYA, JAPAN

© **FURUNO ELECTRIC CO., LTD.**

9-52 Ashihara-cho,
Nishinomiya, Japan

Telephone : 0798-65-2111

Telefax : 0798-65-4200

Your Local Agent/Dealer

All rights reserved.

Printed in Japan

PUB.No. OME-72410

(DAMI) DS-50

FIRST EDITION : APR. 1996

M : FEB. 12,2003



00080756800



OME72410M0



SAFETY INSTRUCTIONS



WARNING



ELECTRICAL SHOCK HAZARD
Do not open the equipment.

Only qualified personnel should work inside the equipment.

Immediately turn off the power at the switchboard if water leaks into the equipment or an object is dropped into the equipment.

Continued use of the equipment can cause fire or electrical shock. Contact a FURUNO agent for service.

Do not place liquid-filled containers on the top of the equipment.

Fire or electrical shock can result if the liquid spills into the equipment.

Do not disassemble or modify the equipment.

Fire, electrical shock or serious injury can result.

Keep the equipment away from rain and water splash.

Fire or electrical shock can result if the rain or water gets into the equipment.

Do not operate the equipment with wet hands.

Electrical shock can result.

Keep heater away from equipment.

A heater can melt the equipment's power cord, which can cause fire or electrical shock.

Use the proper fuse.

Fuse rating is shown on the equipment. Use of a wrong fuse can result in damage to the equipment.



CAUTION

Do not use the equipment for other than its intended purpose.

Improper use of the equipment can result in personal injury or equipment damage.

Turn off the equipment immediately if you feel it is abnormal.

Turn off the power from the switchboard if the equipment is emitting strange noises or becomes excessively hot. Contact your dealer for advice.

The useable ambient temperature range is 15°C to 55°C.

Do not use the equipment out of the above temperature range.

Do not place objects around the equipment.

Overheating may result.

Do not power the equipment when the transducer is in air.

The transducer may become damaged.

Handle all units carefully.

Damage can lead to corrosion.

Do not use chemical cleaners such as alcohol, acetone and benzene to clean the equipment.

Chemical cleaners can remove paint and markings. Use only a soft, dry cloth. For stubborn dirt, use a soft cloth moistened with water-diluted mild detergent.

When dry docked remove marine life from the transducer.

Remove marine life to maintain good sensitivity.

Do not paint the transducer face. Further, handle the transducer with care.

Paint will affect equipment performance.

WARNING LABEL

A warning label is attached to the units shown right. Do not remove the labels. If a label is missing or is illegible, contact a FURUNO dealer or agent about replacement.

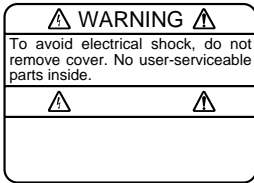

Name: Warning Label (1)
Type: 86-003-1011
Code No.: 100-236-230



MAIN DISPLAY UNIT
DS-500

Warning label

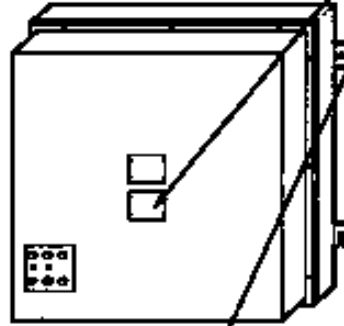

PROCESSOR UNIT
DS-510, DS-511

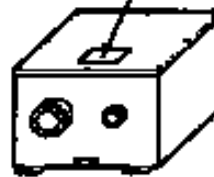

TRANSCIVER UNIT
DS-520

TABLE OF CONTENTS

INTRODUCTION	1
SPECIFICATIONS	2
SYSTEM CONFIGURATION	5
OPERATION	6
Controls and Indications on the Main Display Unit	6
Turning on the Power, Adjusting Panel Brilliance	8
Selecting Speed Tracking Mode	9
Selecting Unit of Speed Measurement	9
Displaying Distance Run or Keel Clearance	9
Setting Distance Run	10
System Settings	11
CONTROL BOX (option) OPERATION	13
MAINTENANCE & TROUBLESHOOTING	14
Preventive Maintenance	14
Troubleshooting	15
Operation Checks	15
Error Displays	17
Program Number	17
PRINCIPLE OF DOPPLER SPEED LOG	18
DIGITAL INTERFACE (IEC 61162-1 EDITION 2)	19
Declaration of Conformity	

SPECIFICATIONS

General Specifications

1. **Ultrasonic frequency** 440 kHz
2. **Number of beams** 3 beams for dual-axis speed indication
3. **Measuring range and accuracy**

Ship's speed	Fore/aft: -10.0 to +40.0 kt Port-Starboard: -9.9 to +9.9 kt
Working depth	Ground tracking: 1 to 200 m beneath the keel Water tracking: 3 to 25 m below hull bottom. (It will change by installation conditions and surrounding water conditions of transducer. The measuring accuracy will be reduced for the depth shallower than 30 m.)
Total distance run	0 to 99999.99 nm
Accuracy (ship's speed)	1.0% or 0.1 kt, whichever is greater. Rolling $\pm 10^\circ$, pitching $\pm 5^\circ$
4. **Display**

Main display unit	LED
Digital indicator	LCD or LED
5. **Input/Output signals**

Input	External keying pulse: 2 ports
Output	Ship's speed: 2 ports (digital) 1 port (analog or through distribution box) Distance signal: 1 port (400 p/nm, forward data only) Distance signal: 6 ports with contact closure signal, 200 p/ nm, contact capacity 30 V, max 0.2A, forward data only. Alarm signal: 1 port (contact closure signal, contact capacity 30 V, max 0.2 A) Keying pulse: 1 port
Digital interface	IEC 61162-1 2nd Edition: 2 ports VBW, VTG, VHW, VLW (VTG is not output when the seabed is not acquired. Heading data in VTG and VHW is "null".)
6. **Power supply** 100/110/115/220 230 VAC, 50/60 Hz
7. **Environmental conditions** Standards: IEC 945 test methods

In-bridge units	-15°C to +55°C
Relative humidity	95% at 40°C

Note: Performance may be affected by air bubbles, interference and other factors.

Specifications of DS-350/351 Digital Display (option)

1. Display device	DS-350: LCD, DS-351: LED
2. Indication	
Speed	Fore/Aft: □□.□□ Port/Starboard: □.□□
Unit	Knots or meters/second
Direction	↑↓ (Fore/Aft), ← → (Port/Starboard)
Mode	Ground or Water tracking
Depth (clearance)	□□.□ m
3. Other features	Dimmer controls, Mode selector, Unit of speed selector
4. Power consumption	DS-350: 12 VA, DS-351: 44 VA

Specifications of DS-370 Distribution Box (option)

1. Input signal (TTL level)	Digital speed signal Log signal (400 p/nm) Alarm signal Power on/off signal
2. Output signal	The following output boards are available optionally.
(1) OTX board	Serial signal for DS-350/351 Digital Indicator and/or cascade connection of DS-370 Distribution Box (1 port /1 board)
(2) ODD board	BCD serial signal for DS-720/DS-370/DS-377 Digital Display (Analog current signal for analog display, 1 board), -2.5 mA to 10.0 mA/-10 kt to 40 kt or -3.33 mA to 10.0 mA/ - 10 kt to 30 kt
(3) OAD board	Analog current signal for analog display, 1 board, -2.5 mA to 10.0 mA/-10 kt to 40 kt or -3.33 mA to 10.0 mA/-10 kt to 30 kt
(4) OLG board	For Distance Indicator (1 port /1 board) and Log signal (3 ports /1 board, 200/400 p/nm contact closure signal, 30 V/0.2A or RS-422 current loop signal). One Log signal port can be modified for Fore/aft status signal port (contact closure signal, 30 V/0.2A or RS-422 current loop signal).
(5) OAC board	Ship's speed current voltage signal (1 port /1 board), Current signal (4.0 mA to 20.0 mA/-10 kt to max, speed, max impedance: 250 ohms)

(6) OAV board

Ship's speed voltage signal (1 port / 1 board), voltage signal (-2.50 to 10.0 V/-10 kt to 40 kt, -3.33 V to 10.0 V/-10 kt to 30 kt, -4.00 V to 10.0 V/-10 kt to 25 kt, -5.00 V to 10.0 V/-10 kt to 20 kt, max, impedance: 1 kohm) + Fore aft status signal (RS-422 current loop)

3. Power supply and power consumption

115/230 VAC, 1 ϕ , 50/60 Hz, 50 VA max

Specifications of DS-381 Series Analog Display (option)

- 1. Indication system Dual range system
- 2. Panel dimensions ϕ 200 mm
- 3. Power consumption 5 VA approx.

Specifications of DS-382 Series Analog Display (option)

- 1. Indication system Dual range system
- 2. Panel dimensions ϕ 200 mm
- 3. Power consumption 5 VA approx.

Specifications of DS-501 Control Box (option)

- 1. Installation method Flush mount
- 2. Power consumption 200 mW max
- 3. Illumination LED

Specifications of DS-730 Distance Indicator (option)

- 1. Distance run indication □□□□□.□ nm
- 2. Indication system LCD with dimmer
- 3. Power consumption 2.5 VA approx.

Specifications of DS-760 Series Analog Display (option)

- 1. Indication range -10 to 30 kt
- 2. Panel dimensions DS-761/762: ϕ 200 mm
DS-763: ϕ 100 mm
- 3. Power consumption 5 VA approx.

SYSTEM CONFIGURATION

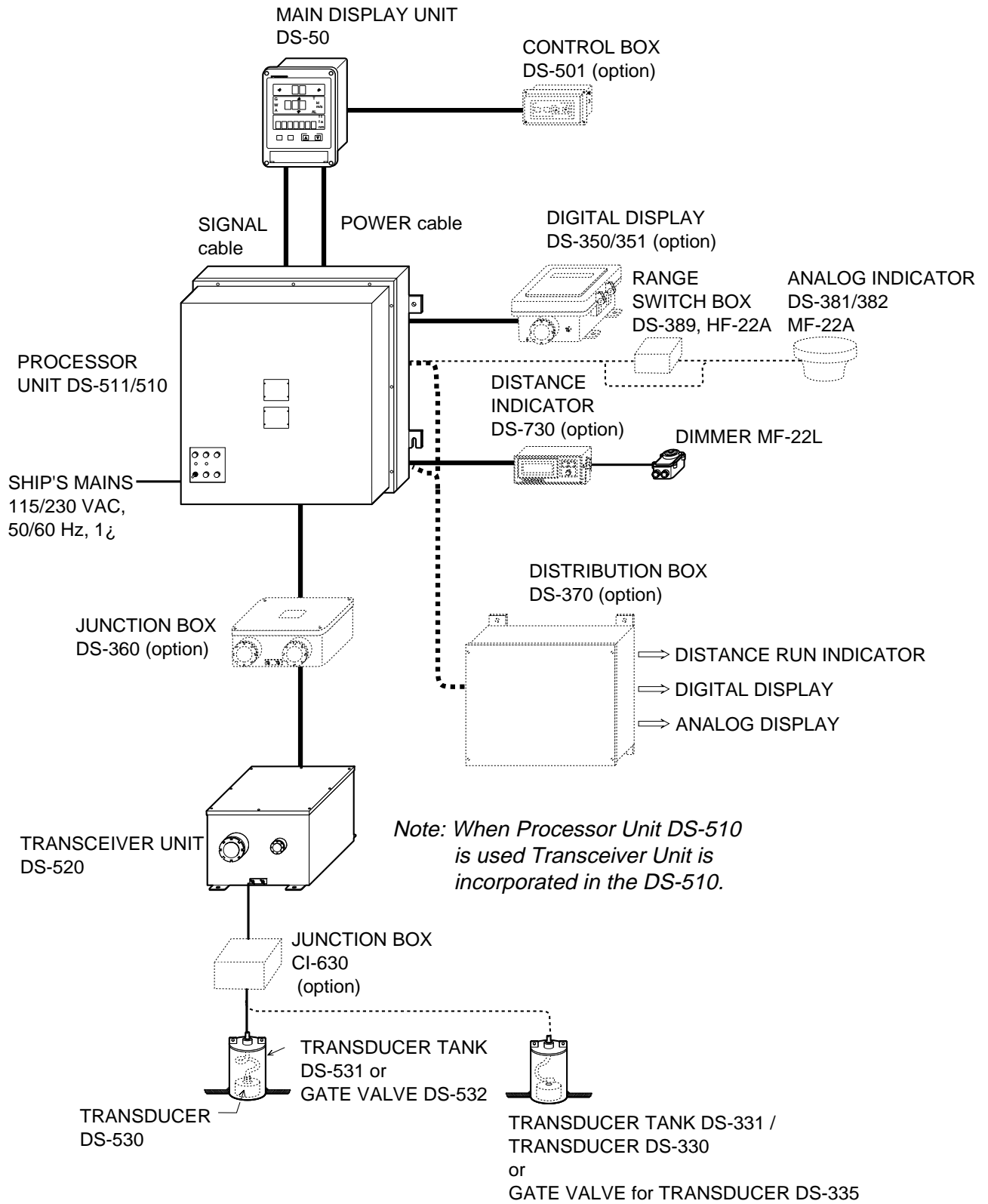

OPERATION

Controls and Indications on the Main Display Unit

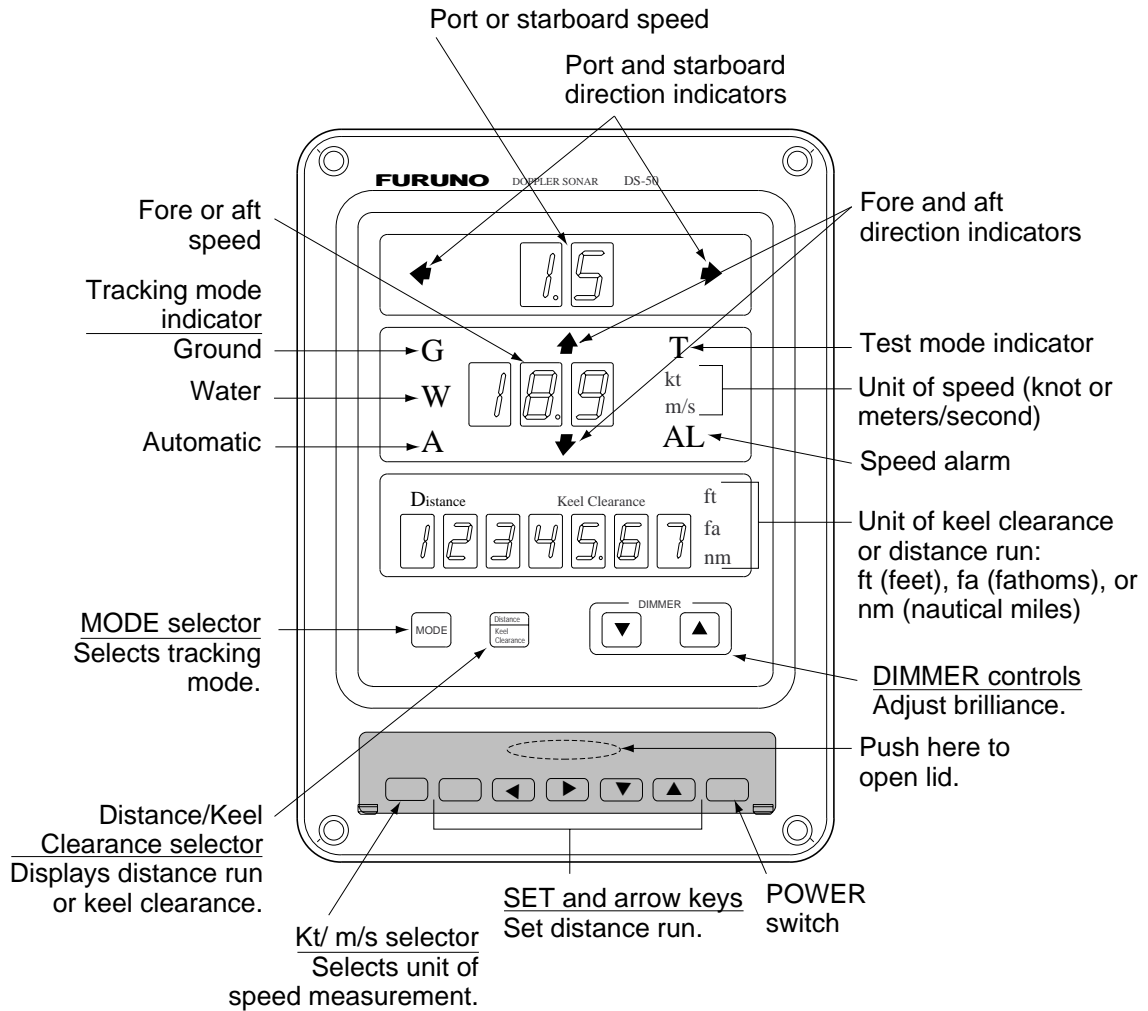

Note: Performance may be affected by air bubbles, interference and other factors.

Control description

Main controls

MODE selector Selects tracking mode among ground, water and automatic. Each time the key is pressed the tracking mode changes in the sequence of ground, water and automatic. Current tracking mode is denoted by the tracking mode lamps.

Distance/Keel Clearance selector Displays distance run or depth below keel at each pressing. "Distance" or "Keel Clearance" lights to show current selection.

DIMMER controls Adjust panel brilliance.

Controls in compartment

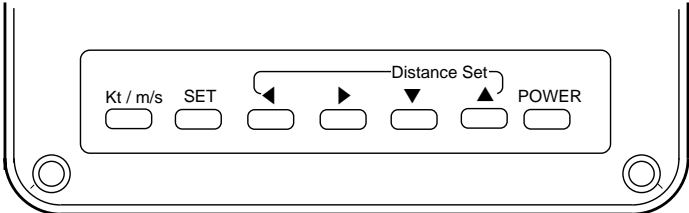

Kt/ m/s selector Selects the unit of speed measurement; knots or meters/second.

SET key Sets distance run display.

Arrow keys Set the distance run indication.

POWER switch Turns power on and off.

Turning on the Power, Adjusting Panel Brilliance

1. Press the [POWER] switch to turn on the power. The equipment is tested in the sequence below:
 - 1) Communications test between main display unit and the processor unit is conducted. Three zeroes blink about 30 s.

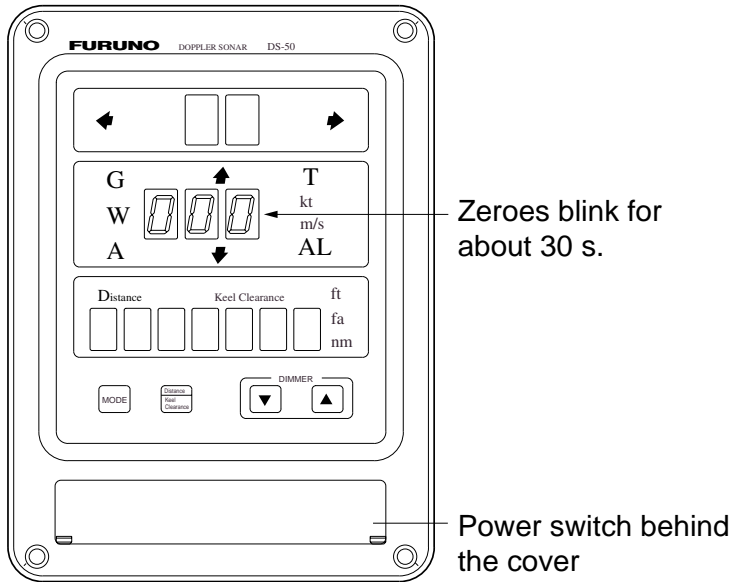

- 2) Testing of main display and processor unit begins. Memory, LEDs and buzzer are tested in order, each tested eight times consecutively. Then the program version number of both the main display unit and the processor unit appear.

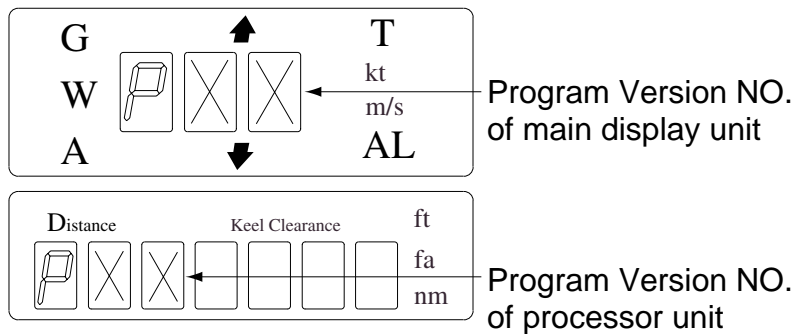

The equipment is normal if the program version nos. appear. If an error is found an error message appears instead of a program version number. Error messages are described on page 16.

- 3) The normal display appears, showing speed and distance run (or depth below keel).
2. Adjust panel brilliance with the [DIMMER] controls. Eight levels of brilliance are available. Selected brilliance appears below the distance run and depth display for 0.5 seconds.

Selecting Speed Tracking Mode

Press the [MODE] selector to select speed tracking mode among water, ground or automatic. Select the mode considering depth and speed. "G", "W" or "A" lights to show mode selected.

G: Measures and displays a speed relative to ground. The depth range usable for this mode is 1 to 200 meters below the keel.

W: Measures and displays a speed relative to the watermass. The depth from the keel to the seabed should be three meters or more.

Note: It is recommended to use the **water tracking mode** in operation with an **ARPA** for collision avoidance task.

A: Automatically selects ground tracking mode or water tracking speed mode depending on depth. Water tracking mode is selected when the keel clearance exceeds 200 meters.

Note: Actual working depth in the ground tracking mode depends on seabed and water conditions, and the reflecting properties for sonic pulses.

Selecting Unit of Speed Measurement

Speed can be measured in knots or meters/second. Press the [Kt/ m/s] selector to select the unit. "Kt" or "m/s" lights to show the selection.

Displaying Distance Run or Keel Clearance

Press the [Distance/Keel Clearance] selector to display distance run or keel clearance (depth). Distance run is always displayed in nautical miles. Keel clearance is the depth from the transducer to the seabed, and can be displayed in meters, feet or fathoms. See page 11 for how to select unit of keel clearance measurement.

Setting Distance Run

The distance run indication is backed up with an internal battery when the power is off. To reset or change the distance run, do the following:

1. Open the lid at the bottom of the display unit and press the [SET] key. The display should look like the illustration below, with the highest digit of distance run blinking.

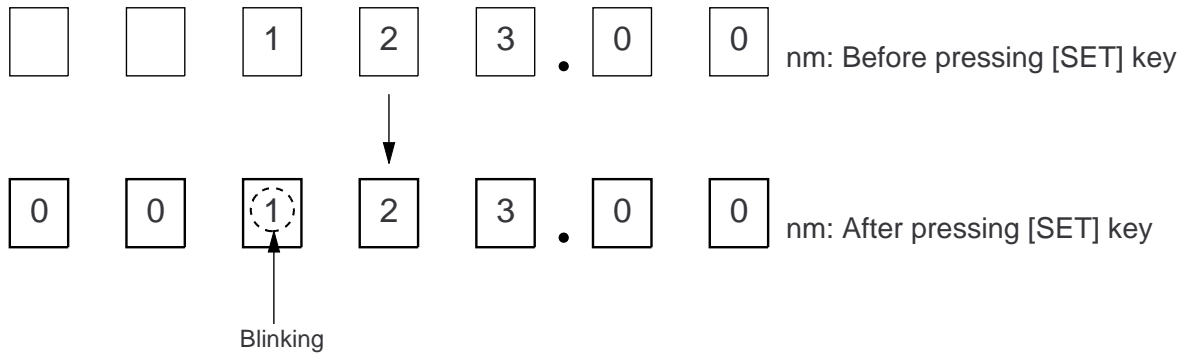

2. Press ◀ or ▶ to place the blinking cursor on the digit to change.
3. Press ▲ or ▼ to set.
4. Repeat steps 2 and 3 to change other digits.

Note 1: Distance run can be reset to zero by entering all zeroes.

Note 2: To restore previous distance run setting, do not operate arrow keys or [SET] key for more than 10 seconds. When this is done the distance run indication stops blinking and then the previous setting is restored. Note that if the ship is moving at this time the distance run indication will change.

5. Press the [SET] key.

System Settings

The system settings do not require frequent adjustment. The table below shows setting range and default setting for each parameter.

No.	Item	Setting Range	Default Setting
1	Ground speed offset	-12.8 to +12.7%, 0.1% steps	0%
2	Water speed offset	-12.8 to +12.7%, 0.1% steps	0%
3	Transducer installation offset	-12.8 to +12.7°, 0.1° steps	0°
4	Trim angle offset	-12.8 to +12.7°, 0.1° steps	0.0°
5	Heel angle offset	-12.8 to +12.7°, 0.1° steps	0.0°
6	Speed averaging	15, 30, 60, 90 sec	15 sec
7	Reference water speed depth	2.0 to 25.0 m, 1 m steps	2 m
8	External KP1 distance	0.0 to +300.0 m, 0.1 m steps	0.0
9	External KP2 distance	0.0 to +300.0 m, 0.1 m steps	0.0
10	Unit of keel clearance measurement	m/ft/fa	m

Note: The above settings are retained with an internal battery when the power is off.

Setting procedure

1. Turn off the main display unit. Turn on the power while pressing and holding down the [Distance/Keel Clearance] selector. "1" indicates system setting no. 1 at the center of the display.

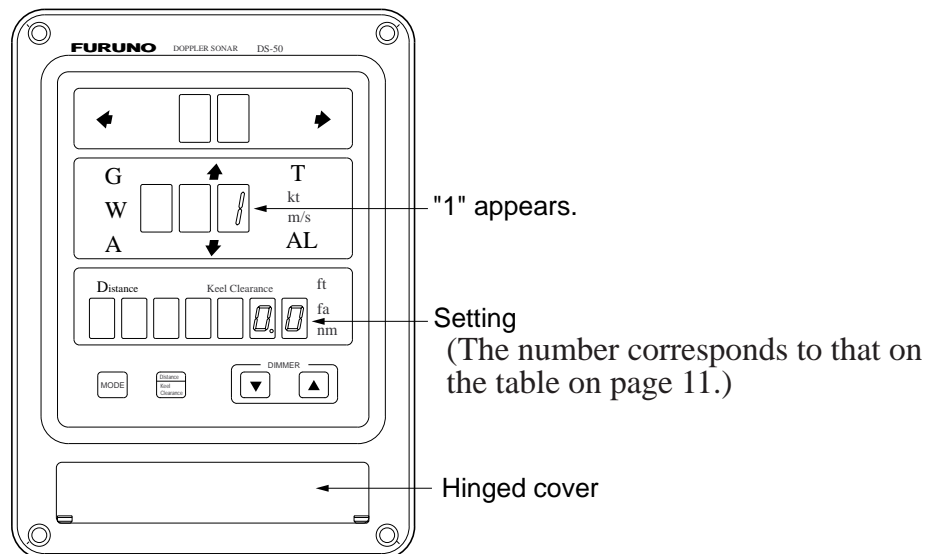

2. Press ▲ or ▼ to select system setting number to be changed.
3. Press ◀ or ▶ to change setting.
4. Press ▲ or ▼ to verify the data entered.
5. Turn off the power, and the new settings are entered in memory.

CONTROL BOX (option) OPERATION

The DS-501 Control Box provides remote operation of the main display unit. The [MODE], [Distance/ Keel Clearance] and [DIMMER] controls function the same as those found on the main display unit.

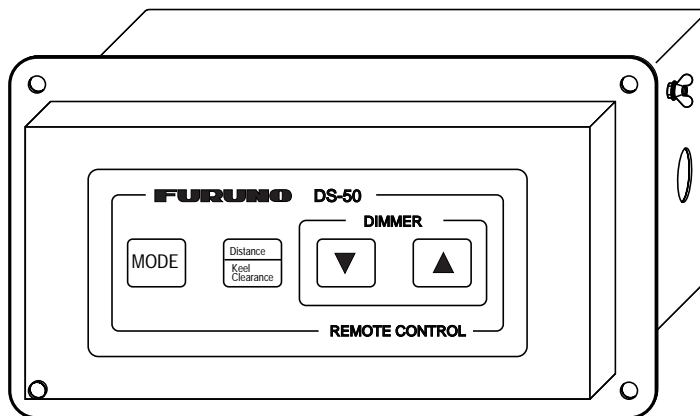

MAINTENANCE & TROUBLESHOOTING

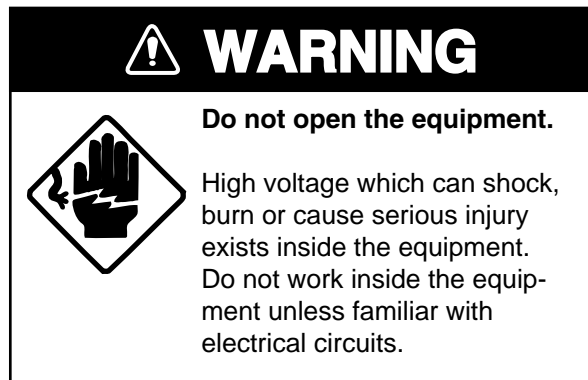

Preventive Maintenance

Monthly checks

Check the following monthly:

- All connectors and cables are securely connected.
- Check ground of main display unit and processor unit for rust. Clean if necessary.
- Check that power voltage is within prescribed rating.
- Conduct the diagnostic program.

Cleaning

Display unit

Dust and dirt may be wiped off the main display unit with a soft cloth. Mild detergent may be used if necessary. Do not use chemical cleaners to clean the unit—they may remove paint and markings.

Transducer

Marine life (barnacles, etc.) on the transducer can cause a considerable drop in sensitivity. When the ship is docked, carefully remove any marine life from the transducer. Paint the transducer yearly with Marine Star 20C (no other paint allowed) anticorrosion paint.

Troubleshooting

Below are simple troubleshooting procedures the operator can follow to restore normal operation.

Power cannot be turned on.

- Try adjusting brilliance (power may be on but brilliance is too low).
- Check the power cable for damage.
- Check that the power connector is firmly fastened.
- Check if fuse(s) on the processor unit have blown. If a fuse has blown, find out the cause before replacing it. Be sure to use proper fuse. Fuse rating appears below fuse holder.

Poor accuracy.

- Check if ground has corroded or ground connection has loosened.
- Check if cables of other equipment are near the transducer cable.

Operation Checks

Main display unit

1. Turn on the power while pressing and holding down the [MODE] selector. The following appears when the equipment is normal:

Port/starboard speed: 0.5 kt ➡
Fore/aft speed: ↑ 18.9 kt
Distance run: 12345.67
Depth: 12.3 (unit according to system settings)

2. Operate the [MODE], [Distance/Keel Clearance] and [Kt / m/s] controls one by one. Confirm that mode or indications changes with each pressing.
3. Confirm that distance run setting can be changed.

Interconnection between main display unit and remote indicators

1. Turn on the power while pressing and holding down the [SET] key. 10.0 kt for fore/aft speed appears. "T" appears to denote the test mode.
2. Confirm that the remote indicators display 10.0 kt. If not, there may be some problem between the processor unit and remote indicators.

Main display unit diagnostic program

The diagnostic program checks the main display unit for proper operation and is automatically conducted at start up. It may also be conducted when necessary. The program checks the memory (ROM, RAM, EEPROM), LEDs and buzzer and then shows the program version number. The equipment is normal if the program version no. appears.

1. To run the diagnostic program, turn on the power while pressing the [Kt / m/s] selector. The program checks the LEDs, ROM, RAM, EEPROM and buzzer and displays the program version number. This is done continuously.
2. To escape from the diagnostic program, turn off the power.

Error display

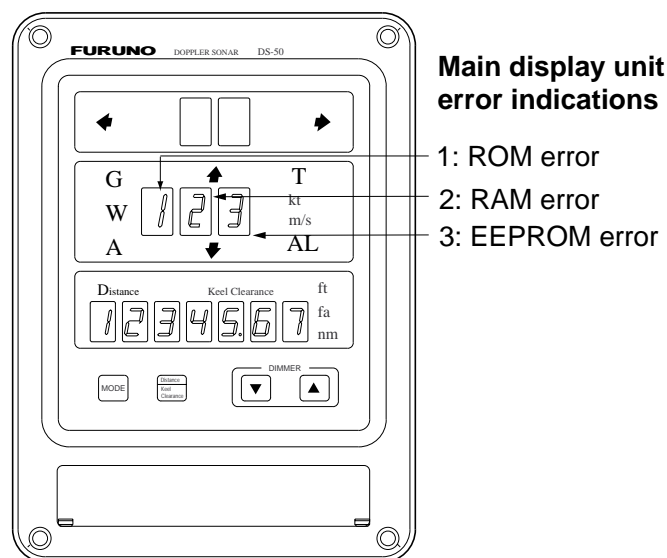

Error Displays

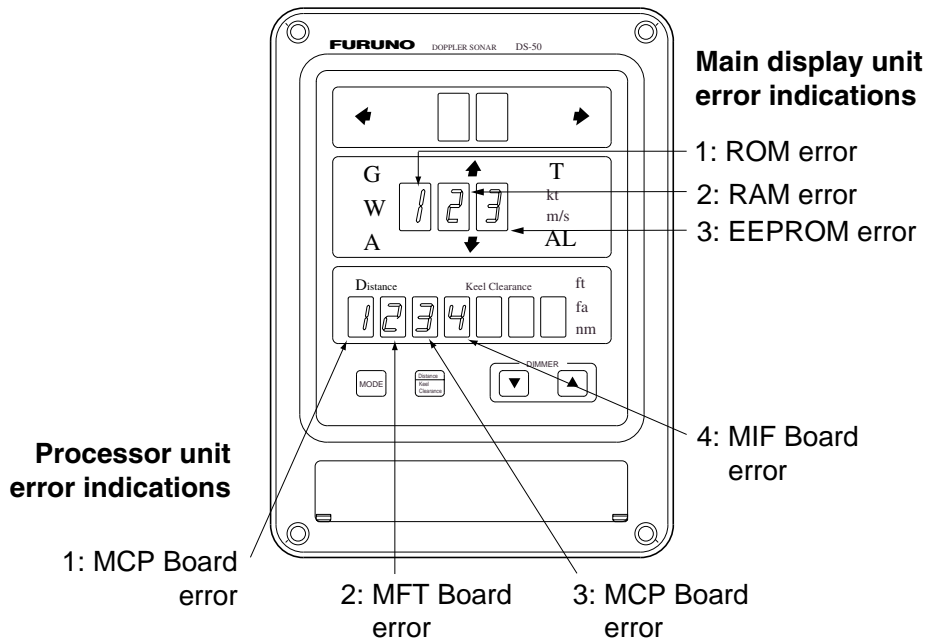

Program Number

Pub No., Modification, Date	Software Program No.
OME-72410-K Modified to fix VTG sentence 7/2002	DS-500 CP board 665-0400-003 DS-510 CP board 665-0410-007 FT board 665-0120-000 IF board 665-0122-001

PRINCIPLE OF DOPPLER SPEED LOG

A doppler speed log measures ship's speed by utilizing the principle of the Doppler effect, which defines that a signal emitted from a moving object is heard with its frequency shifted at stationary locations and the degree of the frequency shift is proportional to the speed of the moving object.

For ease of understanding measurement of ship's fore-aft speed is explained in this paragraph.

Although the DS-50 employs three directional beams, let's suppose that only two beams are used as shown at right.

Ultrasonic pulses are emitted at an angle of θ relative to water line toward ship's fore and aft direction. If the ship's speed is "V", the source of the ultrasonic pulse approaches or goes away the reflecting points on the seabed at a speed of $V \cos \theta$.

This relative motion causes the Doppler shift and the ultrasonic signals reflected at the seabed are received at frequencies of " $f_0 + f_d$ " and " $f_0 - f_d$ " by the transducer. In the processor unit of the DS-50, difference of " $f_0 + f_d$ " and " $f_0 - f_d$ " are computed to extract only the Doppler shift factor " f_d ".

$$(f_0 + f_d) - (f_0 - f_d) = 2f_d$$

Since the ' f_d ' is theoretically given by

$$f_d = 2V \cos \theta \times f_0 / C \quad (C: \text{Sound velocity in water})$$

and f_0 , C and θ are known, V can be calculated if the " f_d " is given.

Note that the sound velocity in water changes with water temperature and water pressure but the change by water temperature is automatically compensated for by using temperature sensor.

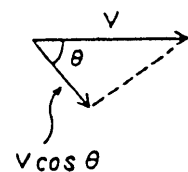
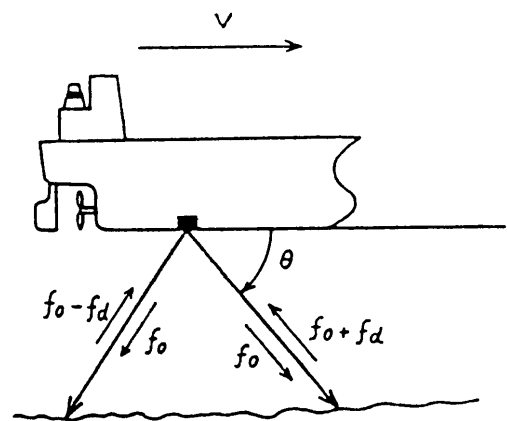

DIGITAL INTERFACE IEC 61162-1

EDITION 2

Output sentences of channel 1, 2 (NMEA/CIF 1, NMEA/CIF 2)

VBW, VTG, VLW, VHW. (VTG is not output when the bottom echo has not been acquired. Heading data in VTG and VHW is "null.")

Transmission interval

1 s for any sentence

Data transmission

Data is transmitted in serial asynchronous form in accordance with the standard referenced in 2.1 of IEC 61162-1. The first bit is a start bit and is followed by data bits, least-significant-bit as illustrated below.

The following parameters are used:

Baud rate: 4800

Data bits: 8 (D7 = 0), parity none

Stop bits: 1

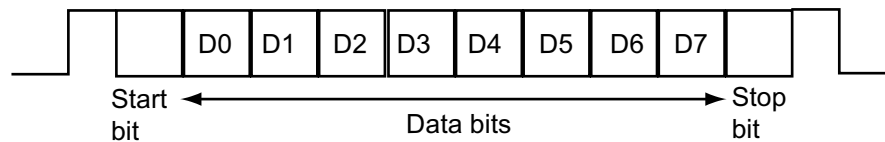

Schematic diagram

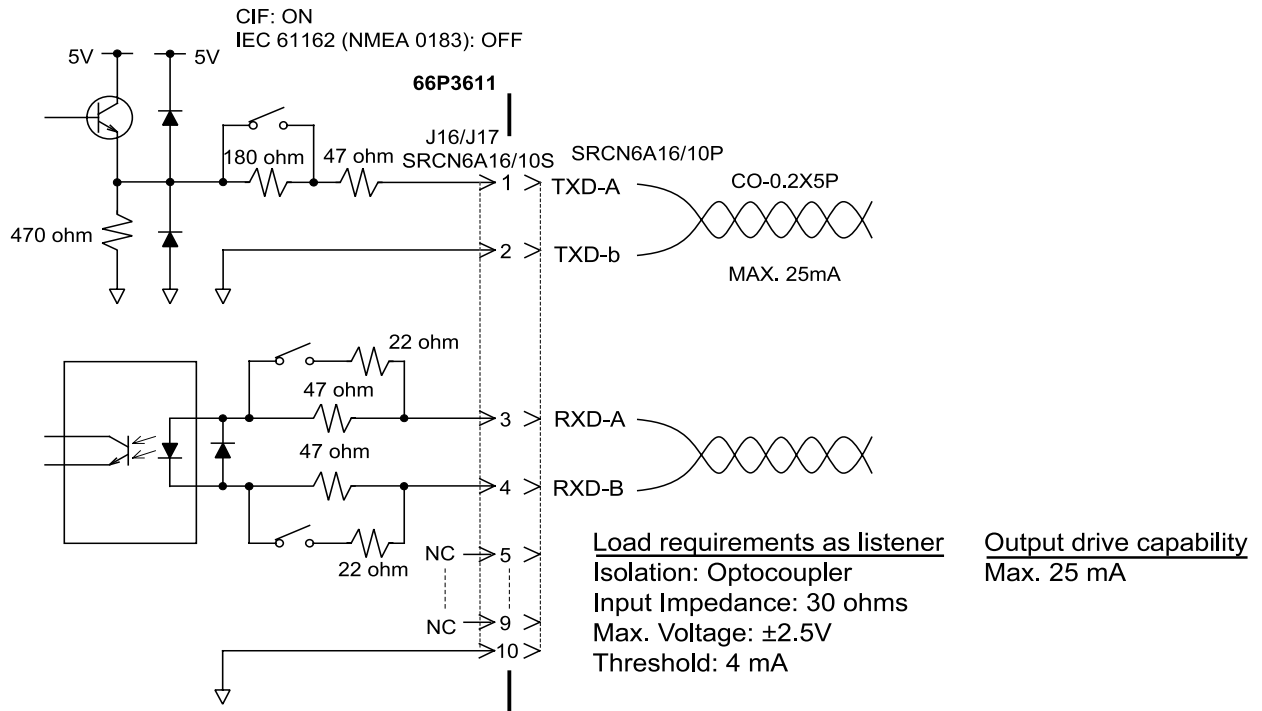

Data sentences

VBW - Dual ground/water speed

\$--VBW,x.x,x.x,A,x.x,x.x,A,x.x,A,x.x,A*hh<CR><LF>

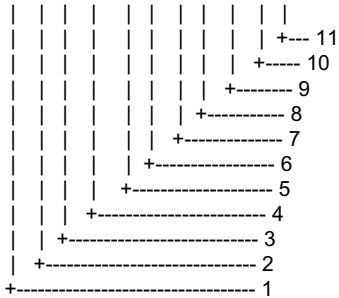

1. Longitudinal water speed, knots
2. Transverse water speed, knots
3. Status: water speed, A=data valid V=data invalid
4. Longitudinal ground speed, knots
5. Transverse ground speed, knots
6. Status: ground speed, A=data valid V=data invalid
7. Stern transverse water speed, knots
8. Status: stern water speed, A=data valid V=data invalid
9. Stern transverse ground speed, knots
10. Status: stern ground speed, A=data valid V=data invalid
11. Checksum

VHW - Water speed and heading

\$--VHW,x.x,T,x.x,M,x.x,N,x.x,K*hh<CR><LF>

```

| | | | | | | | | | +----- 5
| | | | | | | | | | +--+----- 4
| | | | | | | | | | +--+----- 3
| | | | | | | | | | +--+----- 2
| | | | | | | | | | +--+----- 1
  
```

1. Heading, degrees true
2. Heading, degrees magnetic
3. Speed, knots
4. Speed, km/h
5. Checksum

VLW - Distance traveled through water

\$--VLW,x.x,N,x.x,N*hh<CR><LF>

```

| | | | | | | | | | +----- 3
| | | | | | | | | | +--+----- 2
| | | | | | | | | | +--+----- 1
  
```

1. Total cumulative distance, nautical miles
2. Distance since reset, nautical miles
3. Checksum

VTG - Course over ground and ground speed

\$--VTG,,T,,M,x.x,N,x.x,K,a*hh<CR><LF>

```

| | | | | | | | | | | +----- 6
| | | | | | | | | | | +----- 5
| | | | | | | | | | | +--+----- 4
| | | | | | | | | | | +--+----- 3
| | | | | | | | | | | +--+----- 2
| | | | | | | | | | | +--+----- 1
  
```

1. Course over ground, degrees true
2. Course over ground, degrees magnetic
3. Speed over ground, knots
4. Speed over ground, km/h
5. Mode indicator(see note)
6. Checksum

NOTE Positioning system Mode indicator:

- A = Autonomous
- D = Differential
- E = Estimated (dead reckoning)
- M = Manual input
- S = Simulator
- N = Data not valid

The positioning system Mode indicator field shall not be a null field.

This page is intentionally left blank.

FURUNO

FURUNO ELECTRIC CO., LTD.9-52 Ashihara-Cho, Nishinomiya City, 662-8580, Hyogo, Japan
Tel: +81 798-65-2111 Fax: +81 798-65-4200

Pub NO. DOC-465

Declaration of conformity

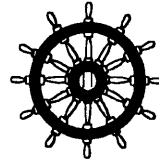

0560

We **FURUNO ELECTRIC CO., LTD.**

(Manufacturer)

9-52 Ashihara-Cho, Nishinomiya City, 662-8580, Hyogo, Japan

(Address)

hereby declare under our sole responsibility that the product

Marine Speed and Distance Measuring Equipment Model DS-50 Doppler Speed Log consisting of Main Display DS-500, Operational Panel DS-501, Processor Unit (Integral transceiver) DS-510 or Processor Unit DS-511 & Transceiver Unit DS-520, Transducer DS-530, and their optional equipment: Digital Indicator DS-351, Analog Indicator DS-382, Remote Distance Indicator DS-730, Junction Box DS-360 and Junction Box CI-630

(Model names, type numbers)

to which this declaration relates conforms to the following standard(s) or normative document(s)

Standard

IMO Resolution MSC.36(63)

IMO Resolution A.824(19), MEC.96(72)

IMO Resolution A.694(17)

Test standard

EN 61023 (IEC 61023: 1999-07)

EN 60945: 1997-01 (IEC 60945 Third edition: 1996-11)

IEC 61162-1: 2000-07

(title and/or number and date of issue of the standard(s) or other normative document(s))

For assessment, see

- Certificate of EC-type-examination N^o: 02212009/AA/00 of 27 May 2002 issued by Telefication, The Netherlands
- Certificate of type approval DERA-TT/50/96-01 of 21 November 1997 issued by DERA Fraser, U. K.
- Certificate of type approval DERA-MED-07/00-02 of 3 March 2000 issued by the DERA Fraser, U.K.
- Report of type testing DERA/SSWI/R/TT/-50/96 of October 1997 issued by DERA Fraser, U.K.
- Test report FLI 12-99-039 of November 8, 1999 prepared by Furuno Labotech International Co., Ltd. and authorized by KCS Certification, The Netherlands

This declaration is issued according to the provisions of European Council Directive 96/98/EC on marine equipment modified by Commission Directive 2001/53/EC.

On behalf of Furuno Electric Co., Ltd.

Hiroaki Komatsu

Manager,

International Rules and Regulations

Nishinomiya City, Japan

June 17, 2002

(Place and date of issue)

(name and signature or equivalent marking of authorized person)