

uSonic-2

Ultrasonic anemometer

User manual

Version 6.56

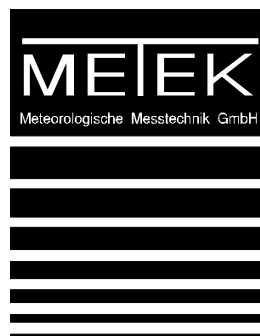

METEK
Meteorologische Messtechnik GmbH

Fritz-Straßmann-Straße 4
D-25337 Elmshorn
Germany

Fon +49 4121 4359-0
Fax +49 4121 4359-20
e-mail info@metek.de
internet <http://www.metek.de>

Version 6.56

Copyright: © 2014 METEK GmbH

All rights reserved. No part of this manual may be reproduced, transmitted, stored in a retrieval system, not translated into any human or computer language, in any form or by any means, electronic, mechanical, optical, chemical, manual, or otherwise, without the prior written permission of the copyright owner.

Index

Chapter 1	Principle of measurement	Page 5
1.1	Physical basics	Page 5
1.2	Measurement of wind velocity	Page 5
1.3	Acoustic temperature	Page 6
Chapter 2	Installation	Page 7
2.1	Mounting the uSonic-2	Page 7
2.2	Adjustment to the north	Page 9
2.3	Installation and connection of the connector	Page 10
2.3.1	Installation of the connector	Page 11
2.3.2	Pin-assignment of the connector	Page 11
2.3.3	Connection of power supply	Page 13
2.3.4	Connection of analog output signals (option)	Page 13
2.3.5	Connection of serial interface	Page 14
Chapter 3	Operating and configuration	Page 15
3.1	Operating with the serial interface (RS422 / RS232)	Page 15
3.2	RS485-mode	Page 16
3.2.1	Connection to a RS485-Bus	Page 17
3.2.2	Disable the RS485-mode	Page 17
3.2.3	Wildcard address	Page 18
3.2.4	Impossible commands in RS485-mode	Page 18
3.2.5	Device specific service address	Page 18
3.3	Serial data output	Page 19
3.3.1	Options of output format of digital output	Page 20
3.3.2	Choice of values with the parameter OD	Page 21
3.3.3	Examples of different serial output formats	Page 22
3.3.4	Averaging time and sampling frequency	Page 23

Chapter 4 Analog data output (option) Page 25

4.1	General function of analog output	Page 25
4.2	Configuration of analog output	Page 25
4.2.1	Limitation of range (offset)	Page 25
4.2.2	Scaling of analog output signals	Page 26
4.2.3	Choice of values for the analog output function	Page 27
4.2.3.1	Test values OA=32	Page 27
4.2.4	Indication of errors by analog output	Page 29
4.2.4.1	Definition of an error	Page 29

Chapter 5 NMEA - protocol Page 30

5.1	Possible settings for command NO	Page 31
-----	----------------------------------	---------

Chapter 6 Parameters and commands Page 33

Overview of all parameters and commands	Page 33
---	---------

Chapter 7 Internal data logger Page 50

Function and operation of the internal data logger	Page 50
--	---------

Appendixes

Appendix A	Technical data	Page 52
Appendix B	Calibration procedure	Page 54
Appendix C	Mechanical drawing	Page 55
Appendix D	Allocation wind components	Page 56
Appendix E	Assembling the connector	Page 57
Appendix F	Packing	Page 58

Appended to this manual you will find a CD-ROM with additional software.

1 Principle of measurement

The uSonic-2 identifies the orthogonal wind components x, y and the temperature from the transit times of ultrasonic pulses. Alternatively, instead of the wind components, the wind velocity and the wind direction are calculated and displayed. The temperature is determined directly from the speed of sound, so this “acoustic temperature” is not equal to the “dry temperature” measured with a usual thermometer or PT100 probe. The temperature derived from the sound speed depends i.e. on the humidity and is in good approximation equivalent to the “virtual temperature”.

Each ultrasonic transducer has its individual delay time to convert an electrical signal into an ultrasonic pulse and reverse. This individual delay time is compensated by a system calibration. In case of strong mechanical impact this calibration has to be updated which can be done by the customer using the optional calibration kit or other adequate helping tools.

The uSonic-2 is constructed with no moving parts so the uSonic-2 is not subject to mechanical aging. Therefore the uSonic-2 is virtual free of maintenance. In addition the measured values of the paths are monitored permanently in view of their quality. In case of deviation out of the acceptance range the system will stop the calculation of data to inform the user that a new calibration is required.

Optionally, the uSonic-2 is available with a sensor head heating which allows operation even under icing conditions.

In this document the name “ultrasonic anemometer” is replaced by its short form “sonic”.

1.1 Physical basics

The 4 ultrasonic transducers are arranged by the geometry of the sensor head, that two of them face each other with a distance of approximately 180 mm. Each transducer works as transmitter and receiver alternately, so in total the 4 transducers create 2 measuring paths, called P1 and P2.

1.2 Measurement of wind velocity

The speed of sound depends on the density of air (scalar variable) and the wind velocity parallel to the propagating sound pulse (vector variable). By taking the difference of the travel times of the sonic pulses the scalar variables eliminate each other and the residual radial wind component can be determined along this path.

1.3 Acoustic temperature

By adding the two travel times of the sound pulses along each sound path, the contributions of the radial wind component eliminates each other and the residual sound velocity can be determined which is a measure for the acoustic temperature which corresponds in good approximation to the virtual temperature.

The virtual temperature depends on the humidity and is about 1 ... 2 K higher than the dry temperature measured with a standard thermometer or PT100 probe.

2 Installation

Please check delivery for completeness and good condition before starting installation. Strong damages of the package may be caused by improper transport. In this case a deformation of the sensor head is possible and a new calibration may be required.

Before starting final installation at the measuring site it is recommended to check functionality of the complete system, including peripheral devices and power supply.

Avoid mechanical forces and impacts while transport and mounting the sensor head. The sensor head may be deformed and a malfunction will appear. In this case a new calibration may be required. Please see Appendix B in this document.

Please ship and transport the sensor head always in the original transportation box!

When connecting the system to a power supply and external devices via the serial or analog ports make sure that the pinning is correctly assigned as given by the table on page 12.

2.1 Mounting the uSonic-2

The uSonic-2 can be mounted on a pipe with an inside diameter of 34mm. Please regard that the cable has to be installed inside of this tube.

Alternatively a pipe clamp can be used. Contact METEK GmbH about additional equipment and adapters for masts.

Mount the uSonic-2 as shown at following illustrations and check the **vertical alignment** to get exact measurements.

We recommend keeping a distance of at least 0.3 m to big adjacent structures (walls) of the measuring volume to avoid that the sonic signal is disturbed or reflected.

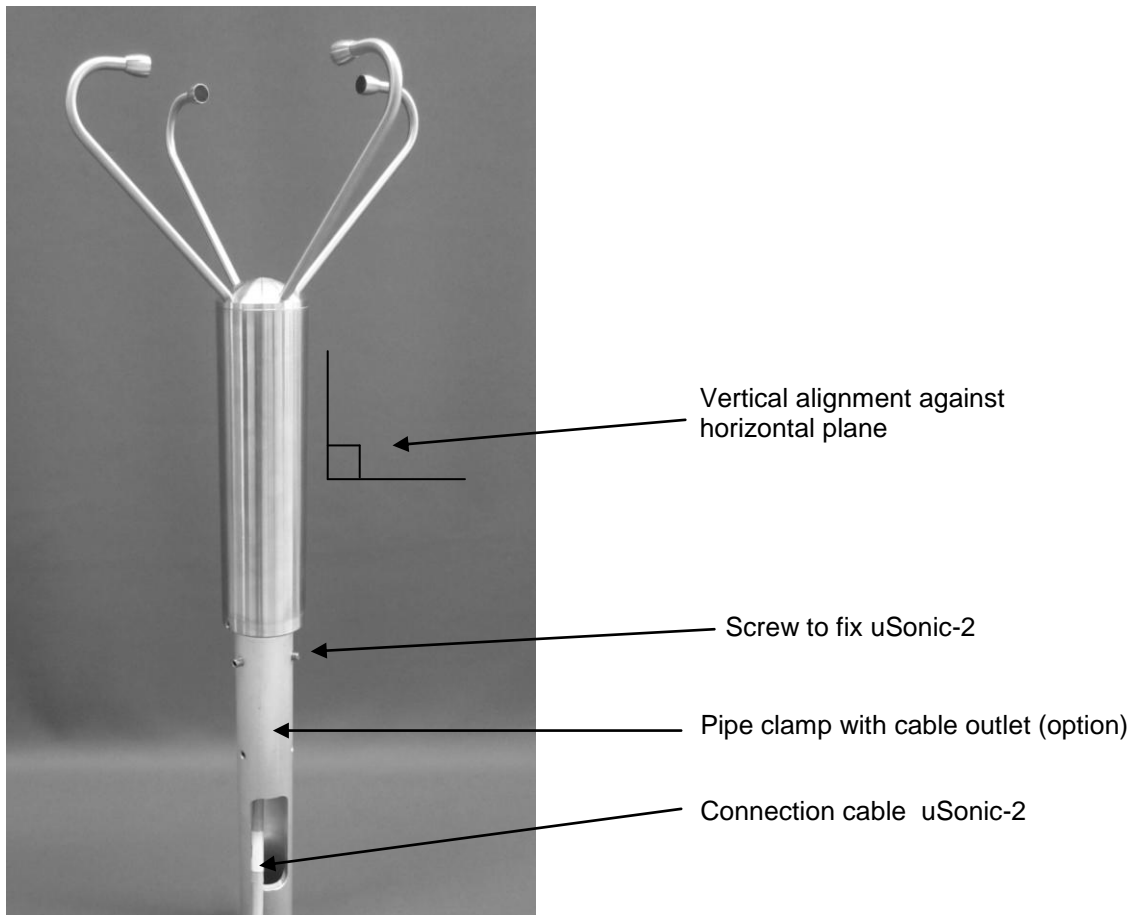

Illustration: Mounting on pipe

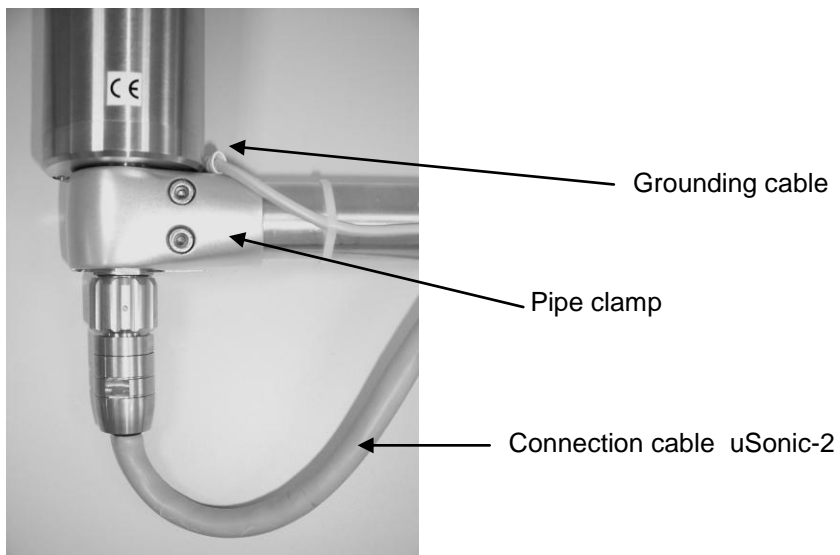

Illustration: Mounting with pipe clamp

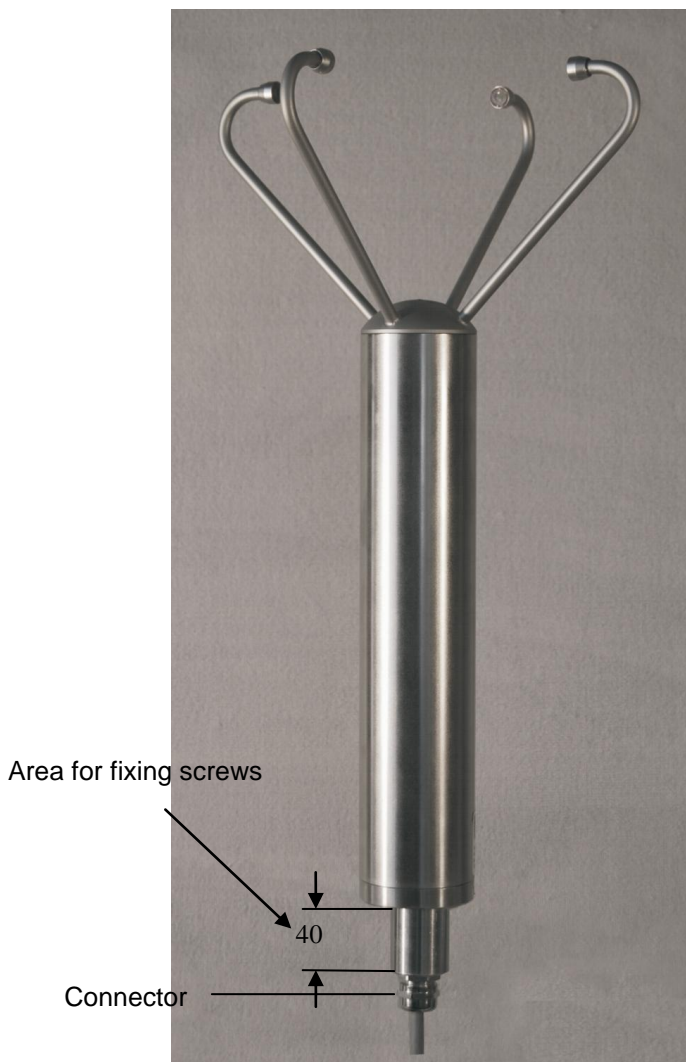

Illustration: Dimensions uSonic-2

Information:

For adequate overvoltage protection you must connect earth grounding to the grounding screw of the sensor.

2.2 Adjustment to the north

To detect the wind direction, the uSonic-2 has to be adjusted exactly to the geographical north.

Consider that the north marker of the uSonic-2 shows to the north and the grounding screw shows to the south.

If an exactly adjustment to the north is impossible, you can correct the adjustment with the parameter **AZ** (Azimuth). See page 36.

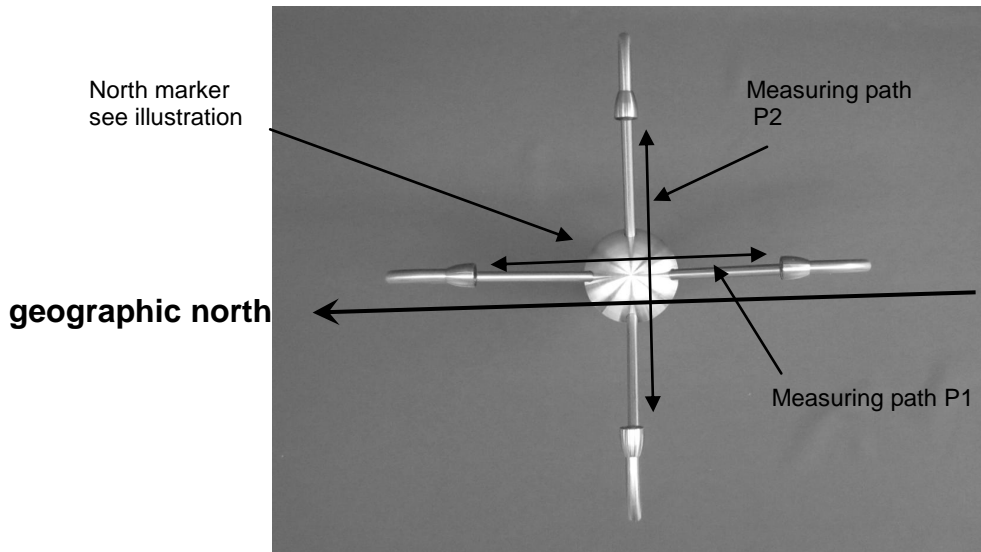

Illustration: Top view uSonic-2



Illustration: North marker

2.3 Installation and connection of the connector

Usually the uSonic-2 is delivered with a compatible connector but without cable. A complete cable with user defined length and with assembled connector is available as an option.

To attach your cable please follow these instructions:

Needed tools are: soldering rod, solder, knife or cutter, wire cutter, 2 x wrench 24 mm or a gripper.

2.3.1 Installation of the connector

Please see Appendix E, assembling connector.

2.3.2 Pin- assignment of the connector

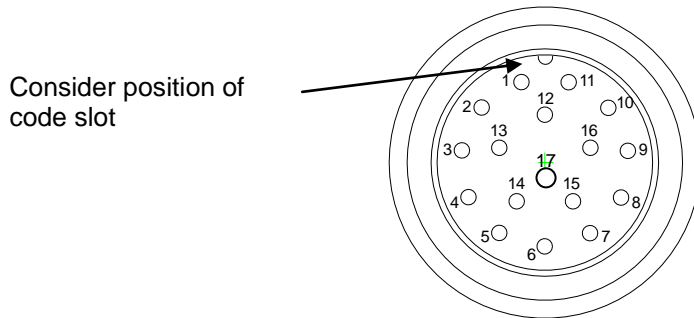

Illustration: Cable connector (female), view at contact sockets

The sonic is optionally delivered with a complete 16 wire connection cable with a cable length configured to contract. For systems without analog output channels a 10 wire cable is optionally delivered.

Cable pinning for a 16-wire cable with analog output channels

Pin	Color	Function	Pin	Color	Function
1	white	+ analog out port 1	9	black	TxD-, Z (RS422) Bus-, Z (RS485)
2	brown	+ analog out port 2	10	purple	TxD+, Y (RS422) Bus+, Y (RS485)
3	green	+ analog out port 3	11	grey-pink	Power supply Electronic + 12...36 V
4	yellow	+ analog out port 4	12	red-blue	Power supply Electronic GND
5	grey	GND analog out	13	white-green	Power supply Heater +24 V
6	pink	TxD (RS232) RxD+, A (RS422) Bus+, Y (RS485)	14	brown-green	Power supply Heater +24 V
7	blue	RxD (RS232) RxD-, B (RS422) Bus-, Z (RS485)	15	white-yellow	Power supply Heater GND
8	red	GND (RS232)	16	yellow-brown	Power supply Heater GND
			17	NC	

Cable pinning for a 10-wire cable without analog output channels

Pin	Color	Function	Pin	Color	Function
1			9	green	TxD-, Z (RS422) Bus-, Z (RS485)
2			10	yellow	TxD+, Y (RS422) Bus+, Y (RS485)
3			11	grey	+ 12...36 V DC, power supply for electronic
4			12	pink	GND, power supply for electronic
5			13	blue	+24 V DC, power supply for heater
6	white	RxD+, A (RS422) Bus+, Y (RS485)	14	red	+24 V DC, power supply for heater
7	brown	RxD-, B (RS422) Bus-, Z (RS485)	15	black	GND, power supply for heater
8			16	purple	GND, power supply for heater
			17	NC	

2.3.3 Connection of power supply

The ultrasonic anemometer uSonic-2 works with an operating voltage of 12...36 VDC. Devices equipped with heated sensor head (option) must be supported with an operating voltage of 24 VDC.

Consider an adequate power capacity for the power supply, especially for models with heated sensor head. Look at specification label uSonic-2 and appendix technical specifications for required max. power.

Note also pin-assignment connector (chapter 2.3.2).

Advise:

Please attend specifications at usage of cables which are not manufactured by METEK GmbH! Attend local regulations, if required.

2.3.4 Connection of analog output signals (option)

The uSonic-2 provides the possibility to display the measured values by 4 analog output ports.

Following configurations are possible:

2 ports 0..10 V or 0..5 V
and
2 ports 0..20 mA

Note also the correct pin assignment (chapter 2.3.2).

The configuration has to be declared at ordering uSonic-2.

It is possible to configure the analog output signals comprehensively.

Please read chapter 4.

Advise:

Please attend specifications at usage of cables which are not manufactured by METEK GmbH! Attend local regulations, if required.

2.3.5 Connection of serial interface

The uSonic-2 provides a serial interface. This is available as a RS232- or a RS422/RS485-type. This serial interface allows the configuration, operation and the data output of the uSonic-2.

The uSonic-2 and the computer (or other devices with a serial interface) has to be connected as following:

RS232

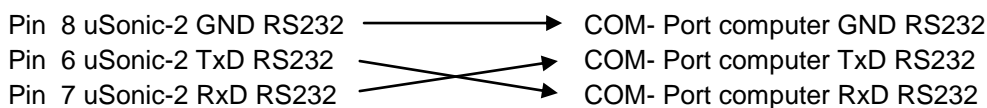

RS422 fullduplex/ RS485 halfduplex

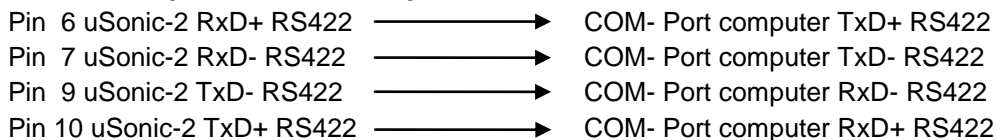

RS485 halfduplex

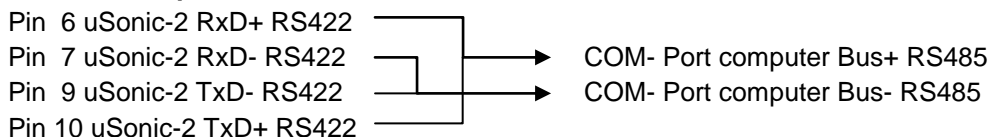

(Pls. note: in RS485 mode Pin 6 and 10 respectively pin 7 and 9 are connected to each other by the serial interface.)

Note also RS485 mode (chapter 3.2)

Advise:

Please attend specifications at usage of cables which are not manufactured by METEK GmbH! Attend local regulations, if required.

3 Operating and configuration

3.1 Operating with the serial interface (RS422 / RS232)

When all connections are done, the communication can be started:

- Start a terminal program, i.e. HyperTerminal, FoxTerm, etc.
- Select the interface, i.e. COM1
- Select following settings:

Bits per seconds (baud rate)	: 9600
Data bits	: 8
Parity	: no
Stop bits	: 1
Flow control	: XON/XOFF

This is the standard configuration of the uSonic-2 (status of delivery).

You will see data, displayed by the uSonic-2, if the connection is working properly.

The displayed data are depending of the configuration of the uSonic-2. In state of delivery, you can see all 10 s data on the computer.

Check now the communication while asking a parameter with the keyboard:

The uSonic-2 accepts ASCII- commands, integral numbers and the character „=" for the value assignment of system parameters and the character "?" to query system parameters.

Every edited line has to be completed with a CR-LF- sequence (carriage return, linefeed – i.e. the ENTER- key).

The uSonic-2 provides the possibility to set and query different system parameters. All commands and parameters are abbreviated with two letters. An equal sign and the value are following.

Advice:

You can see the entering of signs with the keyboard not before completing the command line with the <ENTER>- key on the screen:

Example: **AT=10 <ENTER>** The user is setting the **Averaging Time** to 10s.

C:AT=10 The uSonic-2 is confirming the command.

System parameters can be asked while entering the parameter name, followed by a „?“:

Example: AT?<ENTER>	The user is asking for the Averaging Time
C:AT?	The uSonic-2 is confirming the command
R:AT=10	The uSonic-2 is displaying the Averaging Time

Asking all system parameter:

If you type just a „?“ and the **<ENTER>**- key, the uSonic-2 displays all system parameters, the firmware version and its serial number.

*Tip: You can record the terminal session and store the whole configuration („?“ and the **<ENTER>**- key) of the uSonic-2 . (Example HyperTerminal: Connection – record text)*

A detailed description of all parameters you will find in chapter 6.

3.2 RS485-mode

The RS422- interface of the uSonic-2 can also be used on a RS485- bus. You can choose between a 2-wire-connection and a 4-wire-connection half-duplex-mode.

To start the RS485- mode, an individual address has to be entered. If this is done, the uSonic-2 will just respond to commands including this address.

The automatic data output of the uSonic-2 is stopped. The uSonic-2 will just send required data.

To require data, the commands **RD** (output of the latest averaged data) or **AA** (abort running averaging and output of the data) can be used.

The transmit line (TX) is in “tri- status”- condition, while no transmission is active. The transmit line is high- impedance and other devices of the bus are not affected.

To secure an organized traffic on the bus, a host- pc is necessary.

3.2.1 Connection to a RS485- bus

It is recommended to connect the uSonic-2 to a RS422 or RS485 (4-wire) interface of a computer before connecting to an RS485- bus (2-wire). All settings that are scheduled for operation on the RS485-bus should be made (i.e. sampling frequency, averaging time, etc.). The parameter **EC** should be set to 0 (**EC=0**) to disable the reflection of the commands by the uSonic-2.

The last parameter of these settings should be the address of the uSonic-2. By using parameter **AD**. The allowed range is 001 up to 254. (The address has to be entered in a three digit format). The address 255 is reserved for all connected uSonics to the bus.
(Look **wildcard address**).

Example:

AD=001 ENTER The user is setting the address to 001.

The device is just accessible with the address 001 now. The address has to be embedded into two “#” signs.

Example:

#001#RD ENTER The user is asking for the latest dataset.

#001#Datensatz The uSonic-2 is displaying the latest dataset.

Now you can switch off the uSonic-2 and disconnect it from the computer and connect it to the RS485 bus. If the RS485 bus operates in 2-wire technology, please change the connection from 4-wire to 2-wire technology outside the uSonic-2, directly at the connection to the bus. In general a terminating resistor of 110Ω has to be connected to the RX and to the TX line at the first and the last device of a bus.

3.2.2 Disable the RS485- mode

In case of maintenance jobs, calibration or software updates the uSonic-2 has to be disconnected from the RS485 bus:

Switch off the uSonic-2 and disconnect it from the bus. Connect the uSonic-2 directly to a computer (RS422 or RS485 4- wire) and switch it on again.

At first disable the RS485- mode and set the address to 000:

#001#AD=000 ENTER The user is disabling the
RS485-mode.

Now the uSonic-2 is in the RS422- mode and can be calibrated or similar.

In this mode the uSonic-2 must not be connected to an RS485- bus!!

3.2.3 Wildcard address

Some commands may send to all uSonics connected to the bus connected. The wildcard- address is 255.

Possible commands:

SF=value	Setting the sampling frequency
BR=value	Setting the baud rate
RS	software reset
SO=value	Setting the synchronize- offset
SY=value	Setting the synchronized averaging
AT=value	Setting the averaging time
TI=dd.mm.yy HH:MM:SS	Setting date and time

Example:

#255#AT=600 ENTER	The user is setting the averaging time of all uSonics to 600s.
-------------------	---

3.2.4 Impossible commands in RS485- mode

Some commands are blocked in RS485- mode:

SV	Starting the service mode
Pn=value	Setting of path lengths
TC=value	Setting of calibration temperature
CA	calibration

3.2.5 Device- specific service address

Instead of the device-address (000-254) it is also possible to use the serial number of the uSonic-2. This may be helpful if the device- address is unknown – the serial number is printed on the identification plate.

#0106092525#AD? ENTER	The user is reading out the device- address while using the serial number 0106092525.
#001#AD=001	The uSonic-2 is displaying the device- address.

3.3 Serial data output

The serial data output always starts with a letter. This letter signalizes the status of the uSonic-2 (Exception: **PR=8**, see chapter 3.3.1). This letter is called indicator, followed by a colon „:“.

After this colon the content of the dataset will follow..

Examples:

M:...DATASET...	(M easured data, Heater off) Display of dataset, heater <u>off</u> .
H:...DATASET...	(Measured data, H eater on) Display of dataset, heater <u>on</u> .
D:...DATASET...	(Measured data, Heater D efect) Display of dataset, heater <u>on</u> , but heater <u>defect</u> .
T:19.05.09 14:50:00	(T ime Message)
M:...DATENSATZ...	(M easured data, Heater off) Timestamp with following dataset, heater <u>off</u> .
C:AT?	(C ommand Message) Every command will be reflected after applying with the [ENTER] key.
R:AT=10	(R eplay Message) Display of system information after request of the user or after reset.
E:unknown symbol	(E rror Message) Error message at invalid values or unknown entered commands.

One dataset consists of one line. Additionally a timestamp before and an error message after this dataset is possible.

Every line is closed by a CR-LF (carriage return – line feed) sequence.

3.3.1 Options of output format of digital data output

It is possible to choose the output format (protocol) with the command **PR (Protocol)**:

Possible settings:

- | | |
|------|---|
| PR=0 | Standard protocol
all values are displayed with identifier and space- keys.
See example at chapter 3.3.3. |
| PR=1 | NMEA Protocol
Especially protocol for navigation.
If NMEA- protocol is activated (PR=1), the uSonic-2
is blocking all commands, just the command PR=X is
allowed to change the protocol. |
| PR=3 | One line standard protocol
all values are displayed with identifier, space- keys
and separated by comma in one line.
See example at chapter 3.3.3. |
| PR=8 | One line standard protocol
all values are displayed without identifier, without space- keys
and separated by comma in one line.
After a reset or entering the command LI (List identifier) the
identifier will be displayed one time in one line. |

After the data protocol has been changed by the command **PR=X** with x = 0, 1, 3, 8 the system performs always a system reset (reboot).

3.3.2 Choice of values with the parameter OD (output digital)

The uSonic-2 provides following values:

Value	Scale	Meaning	Measurement range
x	0,01 m/s	x- component of wind	0 ... 60 m/s
y	0,01 m/s	y- component of wind	0 ... 60 m/s
t	0,01°C	acoustic temperature	-40 ... 70°C
v	0,01 m/s	horizontal windspeed	0 ... 60 m/s
vs	0,01 m/s	horizontal windspeed (scalar averaged)	0 ... 60 m/s
d	Grad	wind direction	0 ... 359°
dh	Grad	wind direction (with hysteresis)	0 ... 539°

Choose the displayed values with the command **OD (Output Digital)**:

Value of OD	data set
0	no data output
1	x,y,t
2	v,d,t
3	v,dh,t
32	test values (see below)
64	timestamp (time)
128	timestamp (date and time)
2048	Additional display of data quality

The values OD=1,2 und 3 can be combined with the values 64, 128 and/ or 2048.

Examples:

- OD=0 No data will be displayed.
- OD=2 The values v, d, z and t will be displayed.
- OD=129 The values x,y,z,t and a time stamp (date and time) will be displayed.
(Combination of OD=1 and OD=128 >> OD=129)
- OD=32 Display of test values for functional analysis.

The output of the **test values** is for functional analysis. The test values display the sound propagation time of each ultrasonic transducer. The values are displayed in hex code. The value of "ffff" stands for a malfunction.

Advice:

The value OD= 32 could not be combined with other values.

3.3.3 Examples of different serial output formats

The application of a data logger or diagnosis program it is necessary to know the exactly format of the dataset. The following illustrations describe some different dataset. The empty fields stand for space, CRLF stands for carriage return, linefeed.

Dataset (OD=2, PR=0)

M	:	v	=			4	6	0	d	=				4	t	=				2	1	8	6	C	R	L	F
---	---	---	---	--	--	---	---	---	---	---	--	--	--	---	---	---	--	--	--	---	---	---	---	---	---	---	---

Dataset with time stamp (OD=130, PR=0)

T	:	2	3	.	0	7	.	0	9		1	4	:	4	5	:	0	0	C	R	L	F					
M	:	v	=			4	6	0	d	=				4	t	=				2	1	8	6	C	R	L	F

Dataset with time stamp (OD=66, PR=3) :

M	:	1	6	:	1	0	:	1	5	v	=				1	9	d	=				2	1	0	t	=			2	1	8	6	C	R	L	F
---	---	---	---	---	---	---	---	---	---	---	---	--	--	--	---	---	---	---	--	--	--	---	---	---	---	---	--	--	---	---	---	---	---	---	---	---

Dataset with time stamp (OD=129, PR=8) :

M	:	2	3	.	0	5	.	1	1		1	6	:	1	0	:	1	5	,	-	4	4	,	-	3	0	,	2	2	7	5	C	R	L	F
---	---	---	---	---	---	---	---	---	---	--	---	---	---	---	---	---	---	---	---	---	---	---	---	---	---	---	---	---	---	---	---	---	---	---	---

3.3.4 Averaging time and sampling frequency

The averaging time and the sampling frequency are configured with the commands **AT**, **AV** and **SF**.

- Sampling frequency

One measuring cycle (every ultrasonic transducer transmits and receives one time) takes 20ms. The command **SF** configures, how many measuring cycles will execute in 1000s.

The possible setting is 4000...40000, analog to 4...40Hz.

- Averaging time

The command **AT** defines the averaging time. The uSonic-2 accumulates in this time an averaged value of the the measured values. At the end of this time the uSonic-2 displays the averaged value at the serial interface and refreshes the analog output signals.

The possible setting is 1...3600, analog to 1s...3600s.

- Coherent averaging

The command **AV** defines, if and how many measured values will averaged coherent. The coherent averaging function averages the measured signals directly, *before* sending these results to the processor. The coherent averaging is recommended for **high wind speed application**.

The possible setting is 1...32.

If **AV=1**, every measuring cycle will be processed individually and averaged depending on **AT**.

Example:

- **AV=1, AT=0, SF=25000**
Raw data (25Hz) will be displayed at the serial interface.
- **AV=1, AT=600, SF=10000**
Measuring with 10Hz and display values after averaging 600s.

If **AV>1**, the measuring cycles will be averaged coherent corresponding **AV**.

These results will be averaged corresponding **AT**.

Example:

- **AV=4, AT=10, SF=40000**

4 measuring cycles (40Hz) will be averaged coherent and committed to the processor. The processor averages these results and displays them after 10s.

The processor can handle max. 10 Hz. Consequently the commands **SF** und **AV** are depending of each other and may limit each other.

The formula for valid settings is:

SF/AV=max. 10000 and **SF=max 40000**.

Invalid settings (for ex. **AV=1** and **SF=40000**) are blocked and the message „parameter out of range“ will appear.

4 Analog data output (option)

The uSonic-2 provides 4 analog output signals. Variants of 0...5VDC, 0...10VDC or 0...20mA are available.

4.1 General function of analog output

The 4 analog output signals will stay at the last indicated value until the signals will be refreshed.

The actualization is depending on the averaging time. The refresh of the signals will proceed at the end of this time (simultaneous to the serial output).

4.2 Configuration of analog output

The analog output function supports a variety of parameter to configure the analog output signals exactly.

4.2.1 Limitation of range (Offset)

The command **AO** (analog offset) configures an offset. This offset configures a range which is not used for data output. The not used range supports i.e. an error indication.

The possible setting is 0...50 (% of the whole possible range)

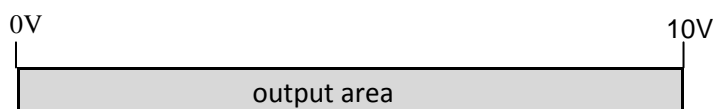

Example: uSonic-2, 0...10V, **AO=0**

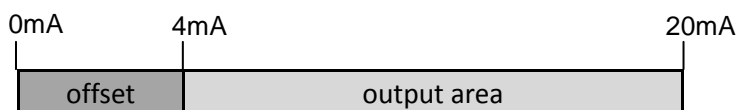

Example: uSonic-2, 0...20mA, **AO=20**

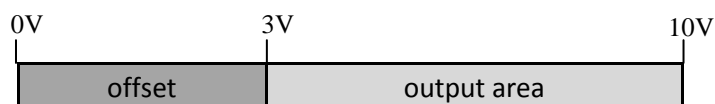

Example: uSonic-2, 0...10V, **AO=30**

4.2.2 Scaling of analog output

To optimize the resolution, the range of the analog output signals can be configured. The commands **VR** and **TR** configure the whole possible range (consider also command **AO**, chapter 4.2.1).

The command **VR** (**v**elocity **r**ange) sets the analog output range for the values x, y, v and vs .

The possible setting is 1...6000 (cm/s).

Examples:

VR=4000 Analog output range at uSonic-2 variant 0...10VDC
v or vs= 0m/s...40 m/s corresponding 0...10VDC
x and y= -40 m/s...+40m/s corresponding 0...10VDC

*The value of **VR** always corresponds to the limited (parameter AO) output range.*

Example:

uSonic-2 variant 0...10VDC, VR=100, AO=20

x or y = -1m/s.....1m/s corresponding 2....10VDC

4.2.3 Assignment of variables to the analog output

The 4 analog output ports C1...C4 can display different values. The following index shows the supported values:

variable	max. range	meaning	scale
x	±60 m/s	x-component of wind	m/s
y	±60 m/s	y- component of wind	m/s
v	0 ... 60 m/s	horizontal wind speed	m/s
vs	0 ... 60 m/s	horizontal wind speed (scalar averaged)	m/s
d	0 ... 359 °	wind direction	°
dh	0 ... 539 ° bzw. -90 ... 449 °	wind direction (with hysteresis)	°

The command **OA** (**O**utput **A**nalog) configures the variables which are displayed on the analog output ports. Following settings are possible:

OA=1: Port 1: **x:** Range determined by command VR
 Port 2: **y:** Range determined by command VR

OA=2: Port 1: **v:** Range determined by command VR
 Port 2: **d:** 0° ≙ setting AO
 360° ≙ maximum value

OA=3: Port 1: **v:** Range determined by command VR
 Port 2: **dh:** 0° ≙ setting AO
 +270° ≙ (maximum value – AO)/2
 540° ≙ maximum value

4.2.3.1 Test values OA=32

The analog output ports can be checked with test values. With **OA=32** the analog output signals are fixed to constant values. The level of the signals depends on the hardware configuration of the uSonic-2 (0 ... 2.5 VDC or 0... 5 VDC or 0...10 VDC) and on the commands **TV** and **AO**.

The possible setting of **TV** is 0...100 (%). An additional function of this command is **TV=101**, see below in this chapter.

Examples:

TV=0 uSonic-2 variant 0...10 VDC / 0...20 mA
AO=0 C1, C2 value: 0 VDC
OA=32 C3, C4 value: 0 mA

TV=50 uSonic-2 variant 0...5 VDC / 0...20 mA
AO=0 C1, C2 value: 2.5 VDC
OA=32 C3, C4 value: 10 mA

The additional function TV=101, defines the analog output ports C1...C4 with different values to check the alignment.

Example:

TV=101 uSonic-2 variant 0...10 VDC / 0...20 mA
AO=0 Port1 value 2.5 VDC (25%)
OA=32 Port2 value 5.0 VDC (50%)
 Port3 value 15 mA (75%)
 Port4 value 20 mA (100%)

Attend also the command OA (see chapter 4.2.1) in this case.

4.2.4 Indicating of errors by analog output

The command **AE** (**analog error handling**) defines which values will appear on all 4 ports if an error is located.

AE=0 C1...C4 the last true value will be hold

AE=1 C1...C4 0VDC or 0mA, if available: the value for **AO**

AE=2 C1...C4 0VDC or 0mA, if available: the value for **AO/2**

AE=3 C1...C4 maximum value

4.2.4.1 Definition of an error

The commands **QT** and **HE** define the circumstances when a fault is present.

The command **QT** defines the threshold of good data quality. If i.e. **QT=70** and the data quality is lower than 70%, an error will be indicated at the analog output ports like defined by the command **AE**.

The data quality is an internal check. The uSonic-2 checks, how many measuring cycles are detected with implausible values. The possible setting is 1...100 (%).

The command **HE** (**heater error**) defines, if a defective heater will be indicated.

HE=0 No indication of defective sensor head heater

HE=1 indication of defective sensor head heater

5 NMEA protocol

A special output protocol type NMEA0183 is offered by the uSonic-2 in order to make the usage in marine applications as easy as possible. Because the NMEA-format requires certain interface adjustments usage of the following commands should be done only if the usage of the NMEA format is essential. As mentioned in chapter 6 there are some options available for this protocol. In general the system is switched to NMEA format mode by entering:

PR=1

The data set is changed according to the NMEA-standards printing out wind velocity and wind direction.

This requires that the parameter assigning the type of data set is adjusted to the value "2" automatically.

OD=2

If *BR* equals zero, the serial interface is automatically switched to a baud rate of 4800. In NMEA mode the system does not accept any commands except

PR=0

which will switch the device back to normal operation. So options for the NMEA protocol must be selected before entering PR=1. These options refer to the setting of the parameters OD, FR and NO (see chapter 6).

The format of the data output is shown in the following example:

Example: \$WIMWV,176,R,2.8,M,A

This line is started by an initializing text string, indicating by the characters MWV that is an information about wind velocity and wind direction is following. The wind direction is displayed with an accuracy of one degree as a three-digit number, followed by the character R for relative angles. The wind velocity is displayed in meters (unit indicated by the character M) as a three-digit number and with an accuracy of one tenth. The validity of the line is signalled by the trailing character A. Invalid lines are marked with the character V. The unit of the wind velocity and the can be selected by the parameter NO. This parameter can as well activate/deactivate the output of the MWV sentence (refer to table in chapter 5.1).

A second line (indicated by MTA) prints the current temperature as a three-digit number with a resolution of 1°C:

Example: \$WIMTA,024,C

The output of this sentence can be activated/deactivated according to the setting of parameter NO (refer to table in chapter 5.1). Additionally a checksum can be applied to each sentence (MWV and MTA). This behaviour is selected by parameter FR. If this parameter is set to 1 the checksum is appended to the end of each sentence by use of the delimiter "*" and appears after this character as a two digit hexadecimal value as defined in the NMEA0183 standard. The value is calculated by XOR'ing the 8 binary data bits of each character of the sentence between the leading "\$" and the delimiting "*".

Example: \$WIMTA,024,C*33

5.1 Possible settings for command NO

parameter value	unit of velocity	talker address	MWV output	MTA output
0 ... 7			disabled	disabled
8	knots	\$II	enabled	disabled
9	mph	\$II	enabled	disabled
10	km/h	\$II	enabled	disabled
11	m/s	\$II	enabled	disabled
12	knots	\$WI	enabled	disabled
13	mph	\$WI	enabled	disabled
14	km/h	\$WI	enabled	disabled
15	m/s	\$WI	enabled	disabled
16	knots	\$II	disabled	enabled
17	mph	\$II	disabled	enabled
18	km/h	\$II	disabled	enabled
19	m/s	\$II	disabled	enabled
20	knots	\$WI	disabled	enabled
21	mph	\$WI	disabled	enabled
22	km/h	\$WI	disabled	enabled
23	m/s	\$WI	disabled	enabled
24	knots	\$II	enabled	enabled
25	mph	\$II	enabled	enabled
26	km/h	\$II	enabled	enabled
27	m/s	\$II	enabled	enabled
28	knots	\$WI	enabled	enabled
29	mph	\$WI	enabled	enabled
30	km/h	\$WI	enabled	enabled
31	m/s	\$WI	enabled	enabled

6 System parameters and control commands

System parameters

Command	Meaning	Page
A1...A4	<u>C</u> alibration <u>a</u> mplitudes	35
AD	Device <u>A</u> ddress	35
AE	<u>A</u> nalog <u>E</u> rrorhandling	35
AO	<u>A</u> nalog <u>O</u> ffset	36
AT	<u>A</u> veraging <u>T</u> ime	36
AV	Total <u>A</u> veraging Number	36
AZ	Device <u>A</u> zimuth	36
BR	<u>B</u> audrate	37
BV	<u>B</u> attery <u>v</u> oltage	37
DT	<u>D</u> ensity <u>t</u> hreshold	37
EC	<u>E</u> cho	38
FR	<u>F</u> rame	38
HC	<u>H</u> ead <u>C</u> orrection	38
HD	Sensor <u>h</u> ead <u>d</u> own	39
HE	<u>H</u> eater <u>E</u> rror	39
HT	<u>H</u> eating (option)	39
LC	<u>L</u> ast <u>C</u> alibration	40
LD	<u>L</u> og <u>D</u> ata	40
LF	<u>L</u> ogger <u>f</u> ree	40
LT	<u>L</u> ogger <u>t</u> otal	40
LU	<u>L</u> ogger <u>u</u> nread	41
MD	<u>M</u> aximum <u>D</u> eviation	41
N0...N3	<u>N</u> ame Parameters	41
NO	<u>N</u> MEA <u>O</u> ptions	41
O1...O4	Calibration offsets	42
OA	<u>O</u> utput <u>A</u> nalog	42
OD	<u>O</u> utput <u>D</u> igital	42
P1, P2	<u>P</u> ath Lengths <u>1,2,3</u>	42
PR	<u>P</u> rotocol	42
QT	<u>Q</u> uality <u>T</u> hreshold	43
SA	<u>S</u> calar <u>A</u> veraging	43
SF	<u>S</u> ampling <u>F</u> requency	44
SN	<u>S</u> erial <u>n</u> umber	44
SO	<u>S</u> ynchronized <u>O</u> ffset	44
SY	<u>S</u> ynchronized Averaging	44
TC	<u>C</u> alibration <u>T</u> emperature	45
TI	<u>T</u> ime and Date	45

TV	<u>T</u>est <u>V</u>alues	45
VD	<u>V</u>ersion <u>d</u>ate	46
VN	<u>V</u>ersion <u>n</u>umber	46
VR	<u>V</u>elocity <u>R</u>ange	46

Control commands

Command	Meaning	Page
AA	<u>A</u>abort <u>A</u>veraging Interval	46
BS	<u>B</u>attery <u>S</u>tatus	47
CA	<u>C</u>alibration	47
L1 ... L3	<u>L</u>oad Parameters	47
LS	<u>L</u>og <u>S</u>tatus	47
RD	<u>R</u>edraw <u>D</u>ata	48
RL	<u>R</u>ead <u>L</u>og	48
RS	<u>R</u>eset	48
S1 ... S3	<u>S</u>ave Parameters	48
SV	<u>S</u>ervice mode	49
VS	<u>V</u>ersion number	49
?	Output of configuration	50

A1... **A4** Calibration amplitudes

These values are internal test numbers and calculated for each transducer by the uSonic-2 within the calibration routine.
Read only.

AD Device Address

Possible settings:

RS422: 0 or 1...99

RS485: 001...255

The command AD defines a device specific address. In the RS422-mode the uSonic-2 responds to commands without an address and to commands with the specified address.

Example:

AD=0 : Address- mode switched off.

AD=45 : The uSonic-2 is now defined with the address 45
in RS422- mode. The data output will be signed with
its address:

45C:AD?

45R:AD=45

See also chapter 3.2, RS485- mode

AE Analog Error Handling

Possible setting 0, 1, 2 or 3

If an error is determined (An error is defined by the commands HE and QT), the analog output ports will stay in a defined status.

AE=0 C1...C4 the last true value will be hold

AE=1 C1...C4 0 VDC or 0 mA, if available: the value for AO

AE=2 C1...C4 0 VDC or 0 mA, if available: the value for AO/2

AE=3 C1...C4 maximum value

See chapter 4.2.4

AO *Analog Offset*

Possible setting 0...50 (% of the total available range)

The command AO configures an offset to the analog output signals. This offset configures a range, which is not used for the data output. The not used range can be used for an error indication.

See chapter 4.2.1.

AT *Averaging Time*

Possible setting 0 ... 3600 (s)

The parameter AT defines the averaging time.

See chapter 3.3.4

AV *Averaging Number*

Possible setting 1 ... SF/1000, max. 32

The command **AV** defines, if and how many measured values will averaged coherent. The coherent averaging function averages the measured signals directly, *before* sending these results to the processor. The coherent averaging is recommended for **high wind speed application**.

See chapter 3.3.4

AZ *Device Azimuth*

Possible setting 0 ... 359

The command AZ defines the compass- reading of the north- marker of the uSonic-2. If it was impossible to mount the uSonic-2 exactly to the north, it is possible correct the data with the command AZ.

AZ is implicated at displaying d, ds, x and y.

Example:

A compass is in line with the north marker of the uSonic-2. The compass needle is indicating 30°. Setting the command AZ=30 will correct the measured data.

BR Baud rate

Possible setting (0, 300, 600, 1200, 2400, 4800, 9600, 19200, 38400, 57600 and 115200)

The baud rate defines the transfer rate of the serial interface. The baud rate of the uSonic-2 and the connected device has to be the same!
The option to set the baud rate to 0 (BR=0) selects the standard value. (4800 for NMEA- protocol and 9600 for standard protocol.)

Example:

BR=19200 The transfer rate of the serial interface is 19200 baud.

BV Battery voltage

Displays the state of the internal battery in mV.

Example:

BV=3627

The level of the internal battery is 3,627V.

Please change the battery or contact METEK if the level is lower than 2500mV.

DT Density threshold

Factory setting for the calibration routine.
Do not change this parameter.

EC Echo *'Echo'*

Possible settings 0 or 1

The command EC defines, if the entered commands will be reflected/ confirmed by the uSonic-2.

EC=0 No reflection of the commands.(recommended for RS485)

EC=1 All commands will be reflected by the uSonic-2 when the ENTER- key is pushed.

FR *Frame*

Possible settings 0,2

The command FR defines if the data output of the serial interface is embedded in a frame of STX and ETX with a checksum control.

FR=0 : Data output without checksum control

FR=2 : STX/ETX embedded data output with two digit hex code checksum

If the **NMEA**- protocol is activated:

FR=0 Data output without checksum control

FR=2 NMEA- defined standard checksum

HC *Head Correction*

Possible settings 0, 5

The command HC activates the sensor head correction. The sensor head correction corrects the influences of the sensor head to the wind components for a horizontal wind flow (i.e. the vertical angle of attack is zero).

The head correction is determined from tests in a wind tunnel at different wind speeds.

Example:

HC=0 : No head correction is active.
HC=5 : The 2D-head correction is active.

HD Sensor head down

Possible settings 0, 1

The command HD defines the mounting of the sensor head.
The wind components will be calculated accordingly.

HD=0 The uSonic-2 is mounted like shown in this manual.
HD=1 The uSonic-2 is mounted with the sensor head downwards.

HE Heater Error

Possible settings 0 or 1

If the heater is switched on and a malfunction of the heater is detected, the analog output ports will get the status defined by command AE.

HE=0 defective heater indication switched off
HE=1 defective heater indication switched on

See chapter 4.2.4

HT Heating, sensor head heater (option)

Possible settings 0, 1, 2 or 3

The command HT controls the operation of the sensor head heater.

HT=0 heater switched off
HT=1 heater switched on
HT=2 heater switched automatically
 (switched on @ $T < 4.5\text{ °C}$; switched off @ $T > 5.5\text{ °C}$)
HT=3 test mode for the sensor heating and must not be used
 by the customer.

If HT is set to “2” the uSonic-2 identifies implausible values after a power new start, the uSonic-2 supposes an iced sensor head and the heater will be switched

on automatically. This may also happen if the sensor is started while stored in a box with reflections which causes implausible data! HT=2 should be used exclusively after the sensor has been installed at site.

LC *Last Calibration*

This information displays the date and time of the last calibration and will be set by the uSonic-2 while calibration procedure and cannot be entered by the user.

LD *Log Data*

Possible setting 0, 1, 2, 55 or 99

The command LD defines the status of the internal data logger

LD=0 stop logging data

LD=1 start logging data, no output of data on the serial line

LD=2 start logging data and output of data on the serial line

LD=55 set back marker for unread data and start logging data

LD=99 erase of internal data logger and start logging data

See chapter 7

LF *Logger free*

Shows the number of free data sets of the internal data logger.

LT *Logger total*

Shows the total number of data sets of the internal data logger.

LU Logger unread

Shows the number of unread data sets of the internal data logger.

MD Maximum Deviation

Possible setting 0 ... 65535

The command MD defines the acceptance criteria of the internal quality check.

Example:

MD=0 The internal quality check is switched off.
MD=20 Recommended setting of criteria.

Advice: The command MD should be modified just in case of necessity. For ex. MD=10 or MD=5, if sensor head has been de-arranged by mechanical impact. Possibly an offline correction must be applied on the measured data. MD=0 should be used only for test purposes.

NO...**N3** Name Parameters

The NO command names the actual configuration (all parameter, including the calibration). The actual configuration can be stored (command S1..S3) and loaded (command L1...L3) with this name.

Maximum number of characters: 31

Example:

N0=20110928 The actual configuration is named 20110928

NO NMEA Options

Possible settings 0...31

The command NO defines the output format of the NMEA protocol.

See chapter 5.

O1...**O4** *Calibration offsets*

These values are calculated for each transducer by the uSonic-2 with the calibration procedure and cannot be entered by the user.

OA *Output Analog*

Possible setting 0, 1, 2, 3 or 32

The command OA defines the selection of the measured data for the analog output ports.

See chapter 4.2.4.

OD *Output Digital*

Possible setting 0...255

The command OD selects a data set for the serial output

See chapter 3.3.2.

P1**P2***Path Lengths 1,2*

Possible setting 1000 ... 4500 (0,1mm)

The commands P1 and P2 define the path lengths. The path lengths have to be measured and entered for a calibration.

The path lengths should be measured with an accuracy of 0,5mm and the difference between the path lengths should be a maximum of 10mm.

PR *Protocol*

Possible setting 0, 1, 3 or 8

The command PR defines the protocol (format) of the data output via the serial interface.

PR=0 Standard protocol

PR=1 NMEA protocol (chapter 5)

PR=3 one line standard protocol

PR=8 one line standard protocol without identifier and spaces

See chapter 3.3.1

After the data protocol has been changed by the command **PR=X** with x = 0, 1, 3, 8 the system performs always a system reset (reboot).

QT Quality Threshold

Possible setting 0 ... 100 (%)

The command QT defines the threshold of good data quality.

If i.e. QT=70 and the data quality is lower than 70%, an error will be indicated at the analog output ports like defined by the command AE.

The data quality is an internal check. The uSonic-2 checks, how many measuring cycles are detected with implausible values.

See chapter 4.2.4

SA Scalar Averaging

Possible setting 0, 1

The command SA defines averaging method.

SA=0 : vector averaging

The uSonic-2 averages x and y. Then the uSonic-2 accumulates v and d with this values.

SA=1 : scalar averaging

The uSonic-2 calculates v and d at every sample and averages these values. The identifier v will change to vs, the identifier d will stay at d.

SF Sampling **F**requency

Possible setting 4000 ... SF/AV=10000, max. 40000

The command SF defines the number of measurement cycles within 1000s.

Example

SF=10000 Sampling frequency is set to 10Hz

See chapter 3.3.4

SN Serial number

This parameter shows the serial number of the uSonic-2.

SO Synchronized Offset

Possible setting 0...AT-1 (s)

If the synchronized data output (SY=1) is active, it is possible to shift the data output from the full seconds, minutes or hours to another time.

Example:

If AT=600 and SO=480, the averaged data output will be displayed every 8th minute:

00:08:00, 00:18:00, 00:28:00 etc.

SY Synchronized Averaging

Possible setting 0 or 1

The command SY defines if the data output is synchronized with the internal clock of the uSonic-2. If the SY=1, averaging will be finished at complete interval timing

Example:

SY=1 : If AT=15 the averaging time will be finished all full
 15 s intervals, i.e.
 data output @ 11:07:00h

data output @ 11:07:15h
data output @ 11:07:30h etc.

If SY has been set to 1 while the residual interval period is less than 50 % of the nominal interval the interval is extended to the next complete interval.

TC Calibration Temperature

Possible setting -5000 ... 5000 (0,01°C)

To calibrate the uSonic-2, it is necessary to measure the temperature with a thermometer and enter the temperature with the command TC. The calibration temperature can just be entered in the service mode.

Example:

TC=2150 : Calibration temperature is 21,5 °C

See appendix B, Calibration procedure.

TI Time and Date

The command TI sets the date and time of the internal clock of the uSonic-2. The internal clock is battery- buffered.

Format: dd.mm.yy hh:mm:ss

Example:

TI=13.10.11 14:07:00 ENTER

The date and time is set to 13.Oct.2011, 14:07:00

The date and time can just be entered in the service mode.

TV Test Values

Possible setting 0 ... 100 (%) and 101

The analog output ports can be checked with the test values. If OA=32, the analog output signals are defined with a fixed value.

See chapter 4.2.3.1

VD *Version date*

Shows the date of creation of the present firmware version.

VN *Version number*

Shows the present version number of firmware.

VR *Velocity Range*

Possible setting 1 ... 6000 (cm/s)

To optimize the resolution, the range of the analog output signals can be configured.

The command VR sets the analog output range for the values x, y, v and vs.

See chapter 4.2.2

Control commands

AA *Abort Averaging Interval*

The command AA stops the actual running averaging interval. The values will be calculated immediately and displayed on the serial interface. The analog output ports will be refreshed.

To read the data with an external device set the averaging time (AT) higher than needed and abort the interval with AA.

BS Battery Status

The command BS reads out the voltage (scaled in V) of the internal battery. If the voltage is lower than 2,5V, the battery has to be changed.

Example:

C:BS

R:BV = 3.548

The internal battery buffers the internal data logger and the internal clock.

CA Calibration

The command CA will calibrate the uSonic-2.
This command is only accepted in the service mode.

See appendix B, calibration procedure!

L1...

L3 Load parameters

The command L1, L2 and L3 loads the stored configuration.

See also description S1...S3

LS Log Status

The command LS reads out the status of the internal data logger.
The uSonic-2 displays the number of free, used and unread storage spaces.

Example:

C:LS

R:LT total dataset storage of the internal data logger

R:LF free dataset storage of the internal data logger

R:LU unread dataset storage of the internal data logger

RD *Redraw Data*

If LD=0

The command RD displays the latest averaged dataset on the serial interface.

If LD=1

The command RD reads the latest dataset of the internal data logger.

RL *Read Log*

The command RL reads out the internal data logger. The command RL displays the oldest, unread dataset of the internal data logger. This dataset is marked then as read.

If all datasets of the internal data logger are marked as read, a message "end of log" will appear.

The Read Log command is allowed only if LD is set to 1.

RS *Reset*

The command RS starts a reset of the uSonic-2. All parameters are stored in an EPROM, so the uSonic-2 will work after this reset with the same settings.

S1...

S3 *Save parameters*

The command L1, L2 and L3 loads the stored configuration.

The command S1, S2 or S3 stores all parameters, including the calibration parameters, in one of the three internal and independent storages. (S1 stores to storage #1 etc.)

The stored configuration is named as the N0 command is actual set.

The stored configurations can be recalled with the commands L1...L3.

The actual configuration is automatically stored in the internal

See also description L1...L3

SV Service mode

The command SV starts the service mode for 1 minute.

The started service mode is required to enter the following commands:

P1...P3	Enter the path lengths
TC	Enter the calibration temperature
CA	Start the calibration
TI	Set date and time

storage #0. This storage won't be affected by the L1... and S1... commands.

Example:

The commands N0=20110928 and S1 will store the actual configuration with the name 20110928. If the uSonic-2s configuration is changed and the user wants to change back to the stored configuration, the user just needs to enter L1 and the uSonic-2 works in the stored configuration.

VS Version number

The command VS reads out the several system parameters.

Example:

C:VS	
R:SN	serial number of the sonic
R:VN	number of the firmware version
R:VD	date of the generation of the firmware version

? Output of configuration

The command “?” will display all actual commands and parameters of the uSonic-2.

7 Internal data logger

Function and operation of the internal data logger

The uSonic-2 provides an internal data logger. The internal data logger is a first-in/first-out- organized data logger.

The capacity depends on the variant of the uSonic-2.

If the data logger is activated by LD=1, the datasets won't be displayed at the serial interface and will be stored in the internal data logger.

If the capacity of the data logger is exhausted, the oldest datasets will be overwritten.

The stored datasets can be read out with the following commands via the serial interface:

Logger start / stop:

<i>LD=0</i>	Stop logging	The datasets will be displayed at the serial interface and not be stored in the internal data logger.
<i>LD=1</i>	Start logging	The dataset will now be stored in the internal data logger and not displayed at the serial interface.
<i>LD=2</i>	Start logging	The dataset will now be stored in the internal data logger and also displayed at the serial interface.

(See also p. 46, LD- command)

Read out logger:

<i>RL</i>	Read Log	RL displays the oldest, unread dataset of the internal data logger and marks this dataset as read. RL is allowed only if LD=1.
-----------	----------	--

The command RL has to be repeated as often as all datasets are marked as read. If all datasets are read the message “end of log” will appear.

Ask status:

<i>LS</i>	Log status	The uSonic-2 displays the total number and the number of free and unread datasets of the internal data logger.
-----------	------------	--

Advice:

You'll find the DOS- program lcopy.exe and the windows- program USA1LogReader.exe on the delivered CDROM to read out the data logger.

Appendix A Technical data

Measurement range

Wind velocity	0 ... 60 m/s
Wind components	-60 ... 60 m/s
Wind direction	0,1 ... 360 °
Wind direction (with hysteresis).....	0 ... 540 °
Temperatur.....	-40 ... 60 °C

Measurement resolution

Wind velocity.....	± 0.01 m/s
Wind components	± 0.01 m/s
Wind direction	± 0.4 °
Temperature.....	± 0.01 K

Time resolution

Sampling rate.....	4...40 Hz
Averaging intervall.....	1...65535 measured values
Alternatively: Averaging intervall.....	1...3600 s

Analog data output

	12 Bit resolution, 0 (4)...20 mA , 500 Ω max. or 0...10 (or 5 or 2,5) V
Wind velocity (max. range)	0 ... 60 m/s
Wind components (max. range)	-60 ... 60 m/s
Wind direction	0 ... 359 °
Wind direction (with hysteresis).....	0 ... 539 °
Temperature (max. range)	-40 ... 60 °C

Range of velocity and temperature adjustable

Sensor orientation

Azimut	(adjustable)	0 ... 359 °
--------	--------------------	-------------

Power consumption

Sensor elektronik	approx.	2.5	W
Sensor head heater (option).....	approx.	55.0	W

Dimensions

Path lengths.....	180 mm
Sensor head	
Measuring head (Ø × Height)	300 × 165 mm
Sensor height with integrated electronic box.....	490 mm
Mounting clamp (outer Ø × length)	33,7 × 40 mm

Weighths - without cable

Sensor head (integrated electronic box)	2,5 kg
---	--------

Appendix B Calibration procedure

1. Place the uSonic in a zero-wind environment. Close windows and doors. Keep a 1 m distance around the sensor head to avoid reflections.
2. Switch on the power supply and connect the sensor to a computer.
3. Measure exactly the temperature close to the uSonic-2.
4. Measure the path lengths P1 and P2 (See illustration next page).
5. Read out and note HT. (HT? <ENTER>)
6. Enter HT=0 <ENTER> (If the heater was switched on, wait to cool down the sensor head).
7. Start the service mode: SV ENTER
8. The following commands can only be entered in the service mode. The service mode stops after 1 minute automatically. If you are not ready to enter the commands type „SV“ ENTER again and go on.
9. Enter the path lengths.
Important: Add 1 mm to each measured path length to compensate for the 2 silicon lenses, ea. of 0.5 mm thickness !
Enter for example:
P1=1390 ENTER (measured: 138.0 mm and 1 mm added)
P2=1388 ENTER (measured: 137.8 mm and 1 mm added)
See the illustration on page 56 for the allocation of the paths.
10. Enter the calibration temperature.
Enter i.e. TC=2260 ENTER (measured: 22,60°C)
11. Enter CA <ENTER> to start the calibration.
The calibration takes approx. 30 s and the uSonic-2 will answer with „....done“. If an error message appears, please try again.
12. Check now the measured data.
(Temperature like measured, wind components should be $< 0 \pm 10$ cm at zero-wind conditions)
13. Enter the noted value for HT.

Appendix C Mechanical drawing

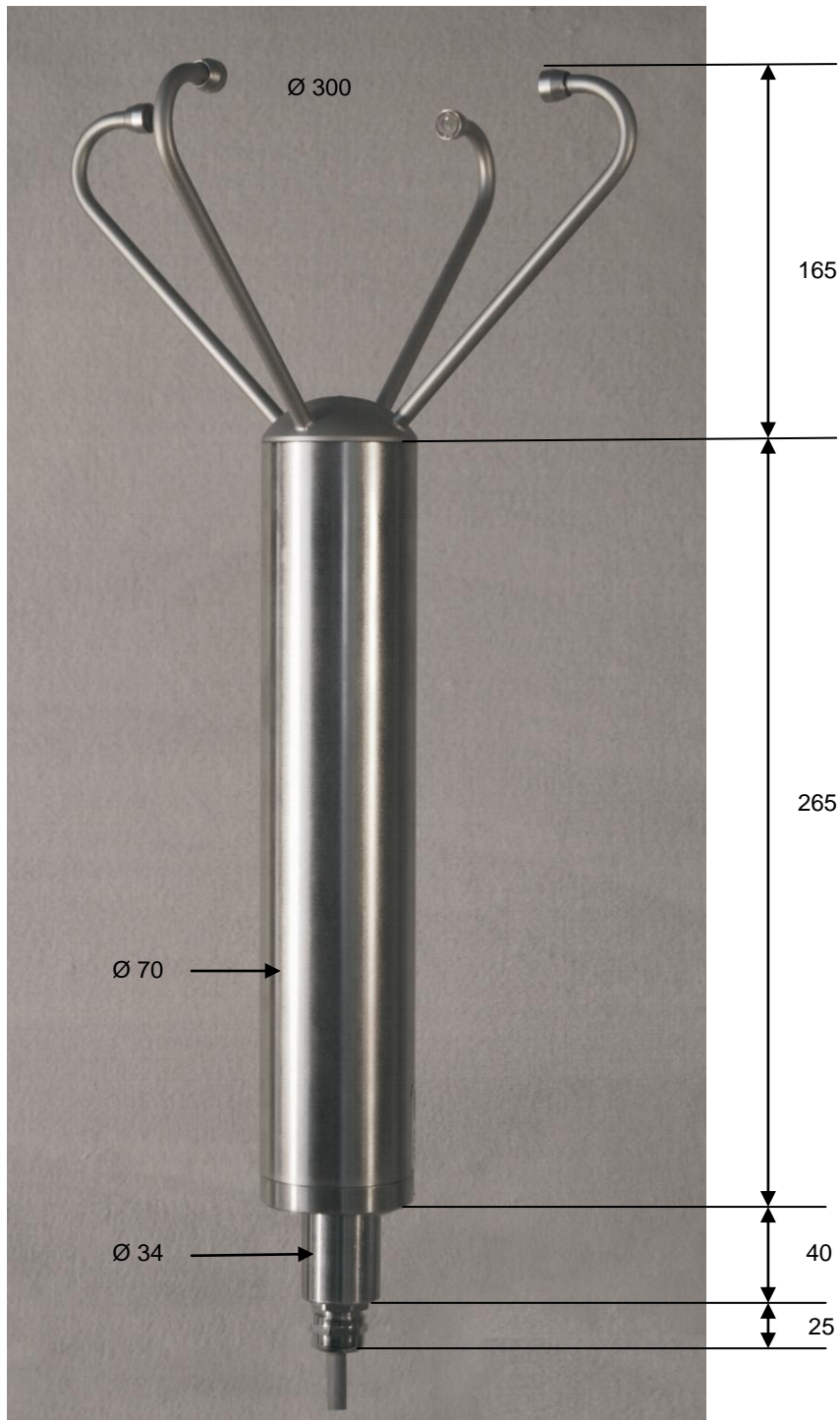

All dimensions are given in mm.

Appendix D Allocation wind components

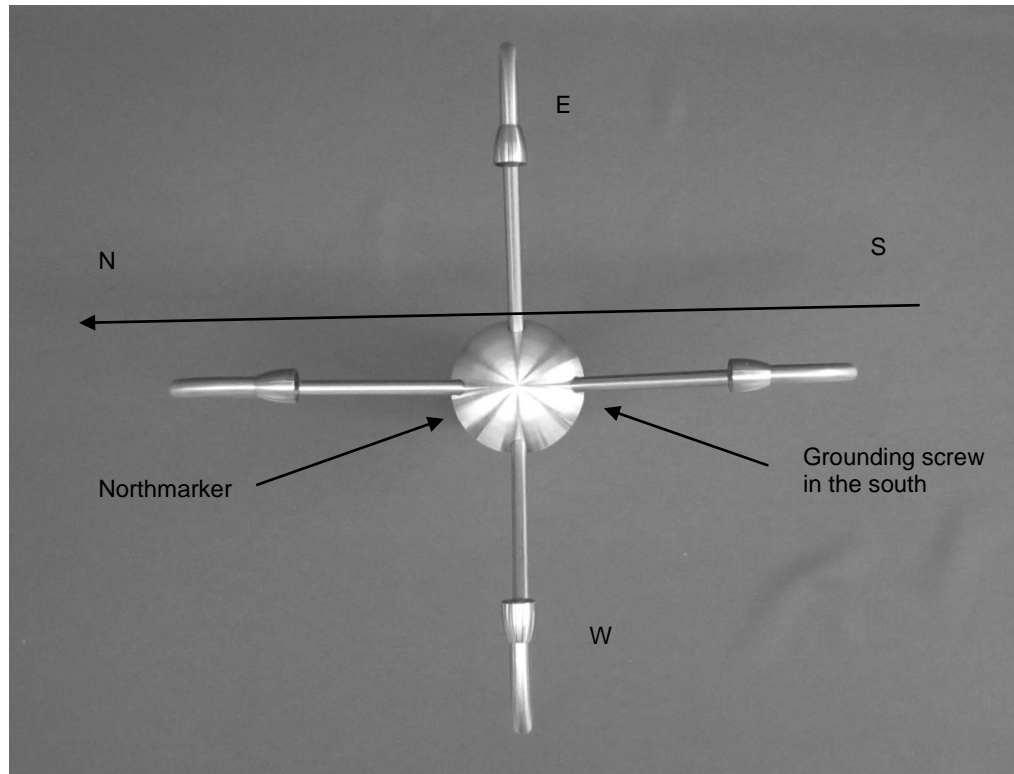

Wind from S to N: $y > 0$
Wind from W to E: $x > 0$

Appendix E assembling connector

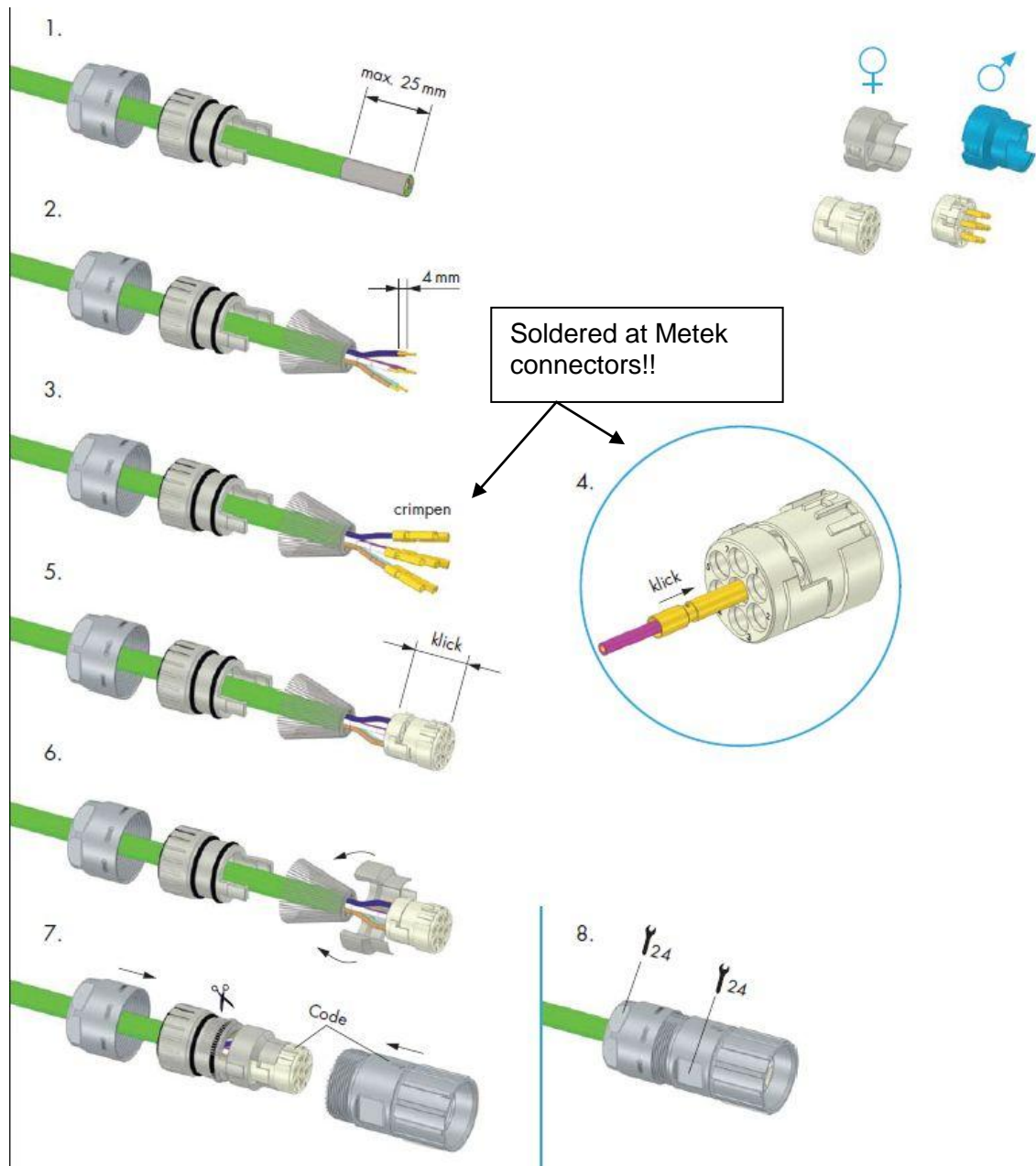

Appendix F Packing

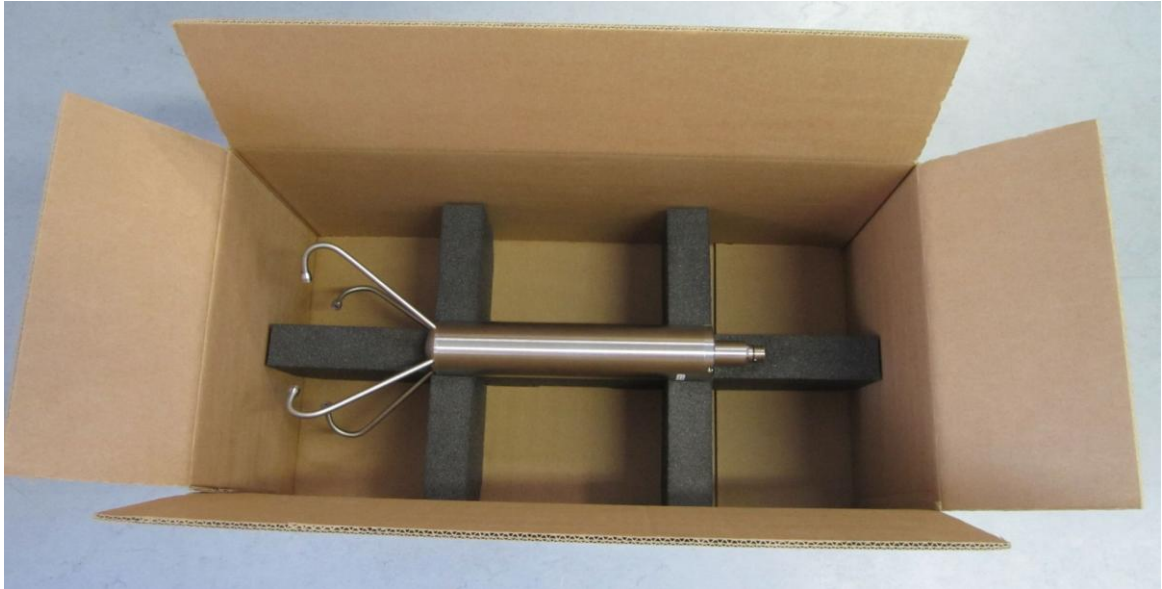

Please use only original box for transport!!