



SEA-BIRD
SCIENTIFIC

User Manual

Release Date: 02/12/2015

SBE Sea-Bird
Electronics

SBE 35 Deep Ocean Standards Thermometer



Manual version
Firmware version
Software versions

- 013
- 2.0a & later
- Seaterm V2 2.4.1 & later
- Seasave V7 7.23.2 & later
- SBE Data Processing 7.23.2 & later



Sea-Bird Electronics
13431 NE 20th Street
Bellevue, Washington
98005 USA

Tel: +1 425-643-9866
seabird@seabird.com
www.seabird.com

Limited Liability Statement

Extreme care should be exercised when using or servicing this equipment. It should be used or serviced only by personnel with knowledge of and training in the use and maintenance of oceanographic electronic equipment.

SEA-BIRD ELECTRONICS, INC. disclaims all product liability risks arising from the use or servicing of this system. SEA-BIRD ELECTRONICS, INC. has no way of controlling the use of this equipment or of choosing the personnel to operate it, and therefore cannot take steps to comply with laws pertaining to product liability, including laws which impose a duty to warn the user of any dangers involved in operating this equipment. Therefore, acceptance of this system by the customer shall be conclusively deemed to include a covenant by the customer to defend, indemnify, and hold SEA-BIRD ELECTRONICS, INC. harmless from all product liability claims arising from the use or servicing of this system.

Declaration of Conformity

Sea-Bird Electronics, Inc.
13431 NE 20th Street, Bellevue, WA 98005 USA

DECLARATION OF CONFORMITY

Manufacturer's Name: Sea-Bird Electronics
Manufacturer's Address: 13431 NE 20th Street
Bellevue, WA 98005, USA

The Authorized Representative located within the Community is:
OTT MESSTECHNIK GmbH & Co.KG
P.O.Box: 2140 / 87411 Kempten / Germany
Ludwigstrasse 16 / 87437 Kempten
Internet: <http://www.ott.com>
Phone: +49 831 5617 – 100
Fax: +49 831 5617 - 209

Device Description: Various Data Acquisition Devices and Sensors

Model Numbers:

3S	3F	3plus	4C	4M	5T	5P	5M	7
8	9plus	11plus	14	16plus V2	16plus-IM V2		17plus V2	18
19plus V2	21	25plus	26plus	27	29	32	32C	32SC
33	35	35RT	36	37-IMP	37-IM	37-SMP	37-SM	37-SIP
37-SI	38	39	39-IM	39plus	41	41CP	43	43F
44	45	49	50	52-MP	53BPR	54	55	56
63	SIM	ICC	IMM	PDIM	AFM	90488	90204	90402
90504	Glider Payload CTD		NiMH Battery Charger and Battery Pack					

Applicable EU Directives: Machinery Directive 98 / 37 /EC
EMC Directive 2004 / 108 /EC
Low Voltage Directive (73 / 23 /EEC) as amended by (93 / 68 /EEC)

Applicable Harmonized Standards:
EN 61326-1:2006 Class A Electrical Equipment for Measurement, Control, and Laboratory Use, EMC Requirement – Part 1: General Requirements
(EN 55011:2007 Group 1, Class A)

EN 61010-1:2001, Safety Requirements for Electrical Equipments for Measurement, Control, and Laboratory Use – Part 1: General Requirements

Declaration based upon compliance to the Essential Requirements and Letter of Opinion from CKC Certification Services, LLC., Notified Body 0976

I, the undersigned, hereby declare that the equipment specified above conforms to the above European Union Directives and Standards.

Authorized Signature: 
Name: Nordeen Larson
Title of Signatory: President
Date: 3 September 2013
Place: Bellevue, WA

Table of Contents

Limited Liability Statement	2
Declaration of Conformity	3
Table of Contents	4
Section 1: Introduction	6
About this Manual	6
Unpacking SBE 35.....	7
Section 2: Description of SBE 35	8
System Description	8
SBE 35 Specifications.....	9
Interface Box Specifications	9
Interface Box Connectors, Switches, and LEDs	9
Dimensions and End Cap Connector	10
Cables and Wiring	11
Section 3: Preparing for Deployment	13
Software Installation	13
Power and Communications Test	14
Test Setup	14
Test	15
Command Descriptions.....	19
Data Formats.....	23
Section 4: Deploying and Operating SBE 35	25
Operation with CTD, Deck Unit, and SBE 32 Carousel Water Sampler	25
Deployment with SBE <i>9plus</i> CTD, SBE <i>11plus</i> Deck Unit, and SBE 32 Carousel Water Sampler.....	26
Deployment with SBE 19, <i>19plus</i> , <i>19plus</i> V2, <i>25</i> , or <i>25plus</i> CTD; SBE 33 Deck Unit; and SBE 32 Carousel Water Sampler	27
Recovery.....	28
Uploading Data from SBE 35.....	29
Comparing SBE 35 Data to CTD Data	31
Operation in Fixed-Point Cells	32
Section 5: Routine Maintenance and Calibration	33
Corrosion Precautions.....	33
Connector Mating and Maintenance	33
Cleaning Interface Box	34
O-Ring Maintenance.....	34
Calibration	34
Calibration Introduction.....	34
Temperature Standards	35
SBE 35 Linearization Calibration	35
SBE 35 Fixed-Point Calibration (Slope and Offset).....	36
Glossary	40
Safety and Electrical Symbols	41

Appendix I: Functional Description42
Measurement Cycle42
Real-Time Clock.....43
Memory.....43

Appendix II: Electronics Disassembly/Reassembly44
Disassembly44
Reassembly44

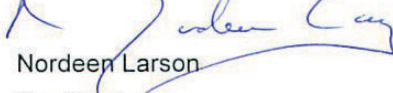
Appendix III: Command Summary45

Appendix IV: References46

Appendix V: Replacement Parts47

Appendix VI: Manual Revision History48

Index.....49

Section 1: Introduction

This section includes contact information and photos of a typical SBE 35 shipment.

About this Manual

This manual is to be used with the SBE 35 Deep Ocean Standards Thermometer. It is organized to guide the user from installation through operation and data collection. We've included detailed specifications, command descriptions, maintenance and calibration information, and helpful notes throughout the manual.

Sea-Bird welcomes suggestions for new features and enhancements of our products and/or documentation. Please contact us with any comments or suggestions (seabird@seabird.com or 425-643-9866). Our business hours are Monday through Friday, 0800 to 1700 Pacific Standard Time (1600 to 0100 Universal Time) in winter and 0800 to 1700 Pacific Daylight Time (1500 to 0000 Universal Time) the rest of the year.

Unpacking SBE 35

Shown below is a typical SBE 35 shipment.



SBE 35



SBE 35 to Interface Box cable



Interface Box



Interface Box to computer cable



AC power cord for Interface Box



Software, and Electronic Copies of Software Manuals on CD-ROM

Section 2: Description of SBE 35

This section describes the functions and features of the SBE 35, including specifications, dimensions, and connectors.

System Description



Note:

Each sample consists of **NCycles** measurements (1 – 127), with the average of the measurements stored and/or transmitted as applicable.

Real-Time Operation:

11*plus* — 9*plus* CTD — Carousel
35

33—Carousel—19/19*plus*/19*plus* V2/25/25*plus* CTD
35

Autonomous Operation:

9*plus* CTD — 17*plus* — Carousel
35

19/19*plus*/19*plus* V2/25/25*plus* CTD—AFM—Carousel
35

The SBE 35 is an accurate, ocean-range temperature sensor that can be standardized against Triple Point of Water and Gallium Melt Point cells as if it were a Standards-grade Platinum Resistance Thermometer (SPRT), but is also capable of measuring temperature in the ocean to depths of 6800 meters (22,300 ft). The SBE 35 communicates via a standard RS-232 interface at 300 baud, 8 data bits, no parity.

The SBE 35 is supplied with an Interface Box for setup and lab use. The Interface Box provides continuous, isolated power to the SBE 35 and buffers the serial communication lines to minimize noise input to the SBE 35 from external sources. When used with the Interface Box, user-selectable operating modes are:

- Sample continuously and output real-time data (data is not stored in EEPROM), or
- Take a single sample, store data in EEPROM, and output real-time data.

The SBE 35 can also be used with the SBE 32 Carousel Water Sampler and one of the following CTD systems:

- **Real-Time Operation**
 - SBE 9*plus* CTD with SBE 11*plus* Deck Unit, **or**
 - SBE 19, 19*plus*, 19*plus* V2, 25, or 25*plus* CTD with SBE 33 Deck Unit
- **Autonomous Operation** (details not documented in this manual)
 - SBE 9*plus* CTD with SBE 17*plus* V2 Searam, **or**
 - SBE 19, 19*plus*, 19*plus* V2, 25, or 25*plus* CTD with Auto Fire Module (AFM)

The SBE 35 makes a temperature measurement each time a bottle fire confirmation is received, and stores the value in EEPROM. Each stored value contains the time and bottle position in addition to the temperature data, allowing comparison of the SBE 35 record with CTD and water bottle data. Using one SBE 35 eliminates the need for reversing thermometers, and provides higher accuracy temperature readings at lower cost.

Calibration coefficients stored in EEPROM allow the SBE 35 to transmit data in engineering units. When configured in a real-time system, the SBE 35 can use the system modem channel for two-way communications; it is not necessary to change cable connections to communicate with and retrieve data from the SBE 35.

Commands can be sent to the SBE 35 to provide status display, data acquisition setup, data retrieval, and diagnostic tests.

The SBE 35 is supplied with a powerful Windows software package, **Seasoft V2**, which includes:

- **Seaterm** and **SeatermV2** – terminal programs for easy communication and data retrieval.
- **Seasave V7** – real-time data acquisition and display.
- **SBE Data Processing** – program for calculation and plotting of CTD parameters and derived variables.

Notes:

- Help files provide detailed information on the software.
- Separate software manuals on CD-ROM contain detailed information on the setup and use of Seasave V7 and SBE Data Processing.
- Sea-Bird supplies the current version of our software when you purchase an instrument. As software revisions occur, we post the revised software on our website. See our website for the latest software version number, a description of the software changes, and instructions for downloading the software.

SBE 35 Specifications

Measurement Range	-5 to +35 °C
Initial Accuracy	± 0.001 °C
Typical Stability (per year)	0.001 °C
Resolution	0.000025 °C
Sensor Calibration	-1.5 to + 32.5 °C
Data Storage	Up to 179 samples (each an average of NCycles = measurements [1 - 127])
Real-Time Clock	Watch-crystal type
External Power	9-16 VDC
Current	<i>On application of power (approximately 1 minute): 140 – 160 mA Operating: 60 – 70 mA</i>
Materials	Aluminum pressure case rated at 6,800 meters (22,300 feet)
Weight	In water: 0.5 kg (1.1 lbs) In air: 0.9 kg (2 lbs)

Interface Box Specifications

Power Requirement	100-240 VAC / 47-63Hz / 0.30A The Interface Box should always be used with a three-terminal outlet that includes a protective earth.
Fuse	3AG, 250VAC Slow-Blow, 0.5 Amp
Dimensions	178 x 127 x 57 mm (7 x 5 x 2.25 inch)
Weight	1.1 kg (2.5 lbs)
Installation Environment	Interface Box operates properly under following conditions: <ul style="list-style-type: none"> • Indoor use • Altitude up to 2000 meters • Temperature from 5 °C to 40 °C • Maximum relative humidity 80% • Mains supply voltage ±10%

Interface Box Connectors, Switches, and LEDs

- *Connections:*
 - *RS-232* - connects to computer
 - *SBE 35* - connects to SBE 35
 - *AC Input* - connects to 100-240 VAC power supply
- *Power switch and LED* - switch turns power to Interface Box on/off. Red *PWR* LED turns on to indicate power is on.
- *LEDs* - indicate if the Interface Box is communicating with other parts of the system:
 - Yellow *TX* LED - flashes when message is received from SBE 35
 - Green *RX* LED - flashes when message is transmitted to SBE 35

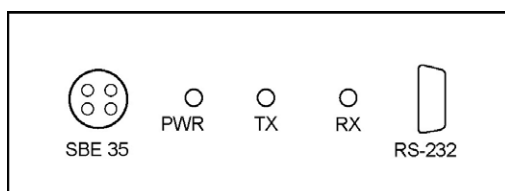

Interface Box (front)

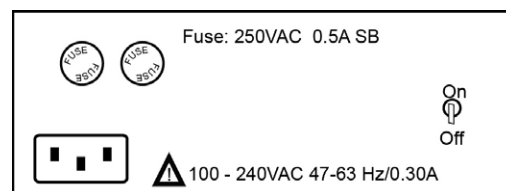

Interface Box (back)

Dimensions and End Cap Connector

Note: Sensor guard not shown. **Ensure guard is installed when deploying at sea.**

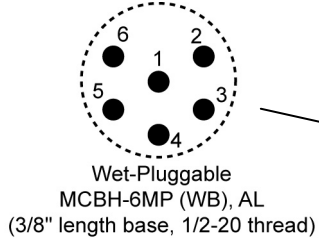
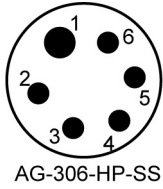

Pin	Signal
1	Ground
2	Receive from SBE 9plus, SBE 33, or Interface Box
3	Transmit
4	N/C
5	Bottle fire confirmation from Carousel
6	Power +9 to +16V

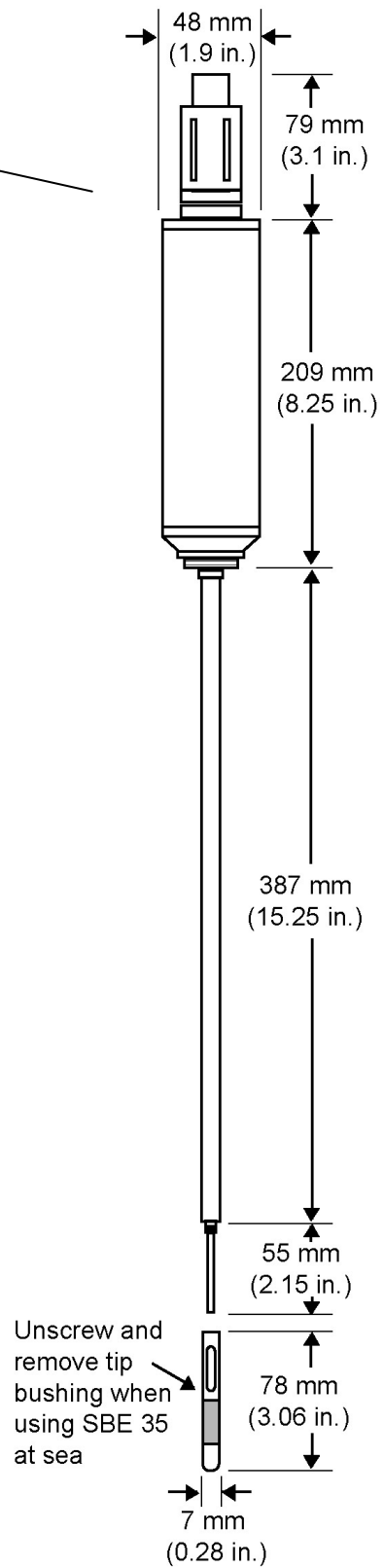

Cables and Wiring

**6-pin to MS cable –
SBE 35 to Power
Supply / Interface Box**

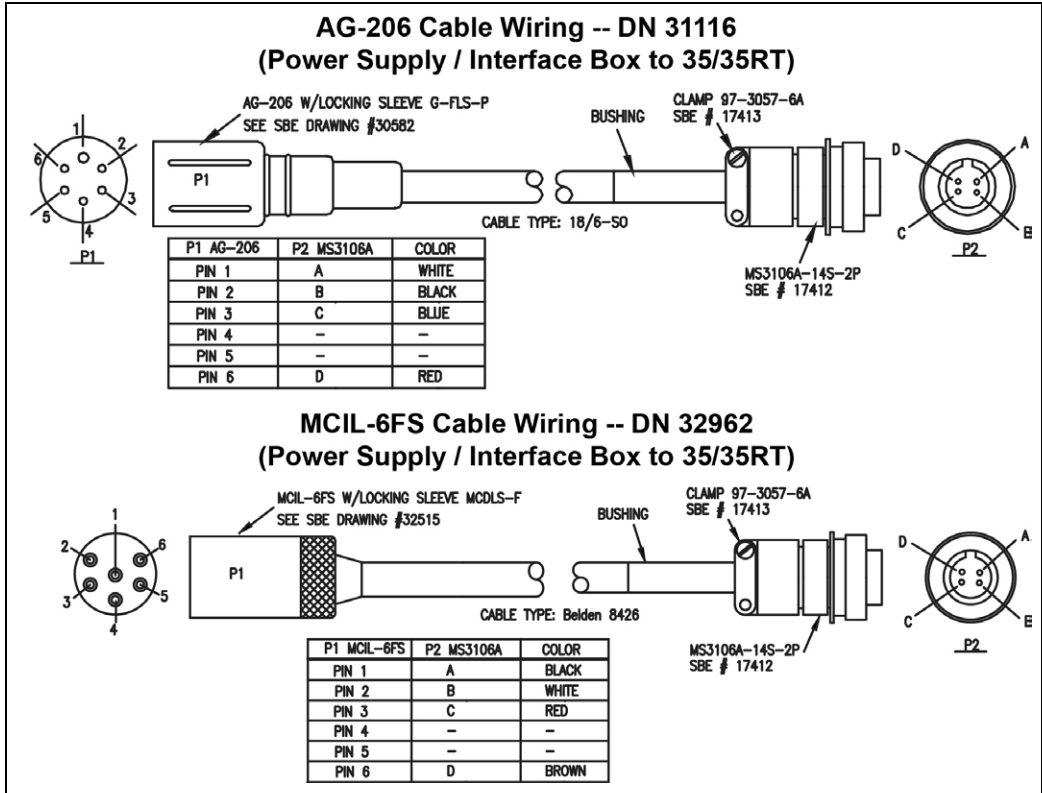

**DB9 to DB9 cable –
Power Supply /
Interface Box
connector to
computer**

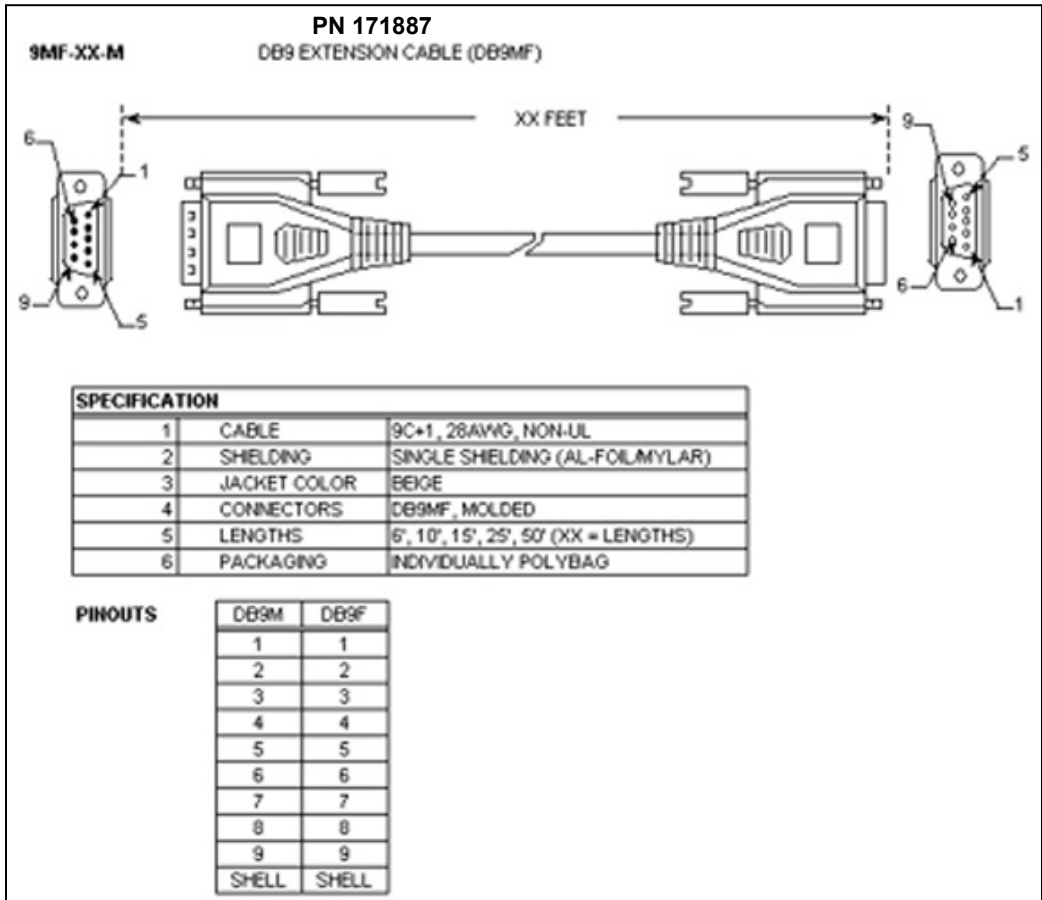

6-pin to 6-pin cable –
SBE 35 to SBE 32, when
used with SBE 33 Deck
Unit

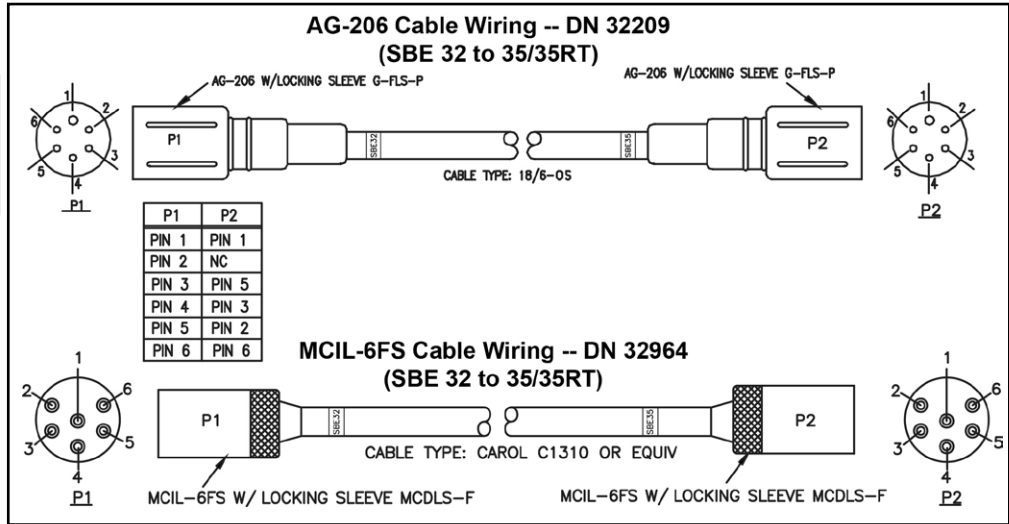

Y- cable – SBE 35 to
SBE 32 and 9plus, or
SBE 35 to SBE 32 and
17plus V2, or SBE 35 to
SBE 32 and AFM

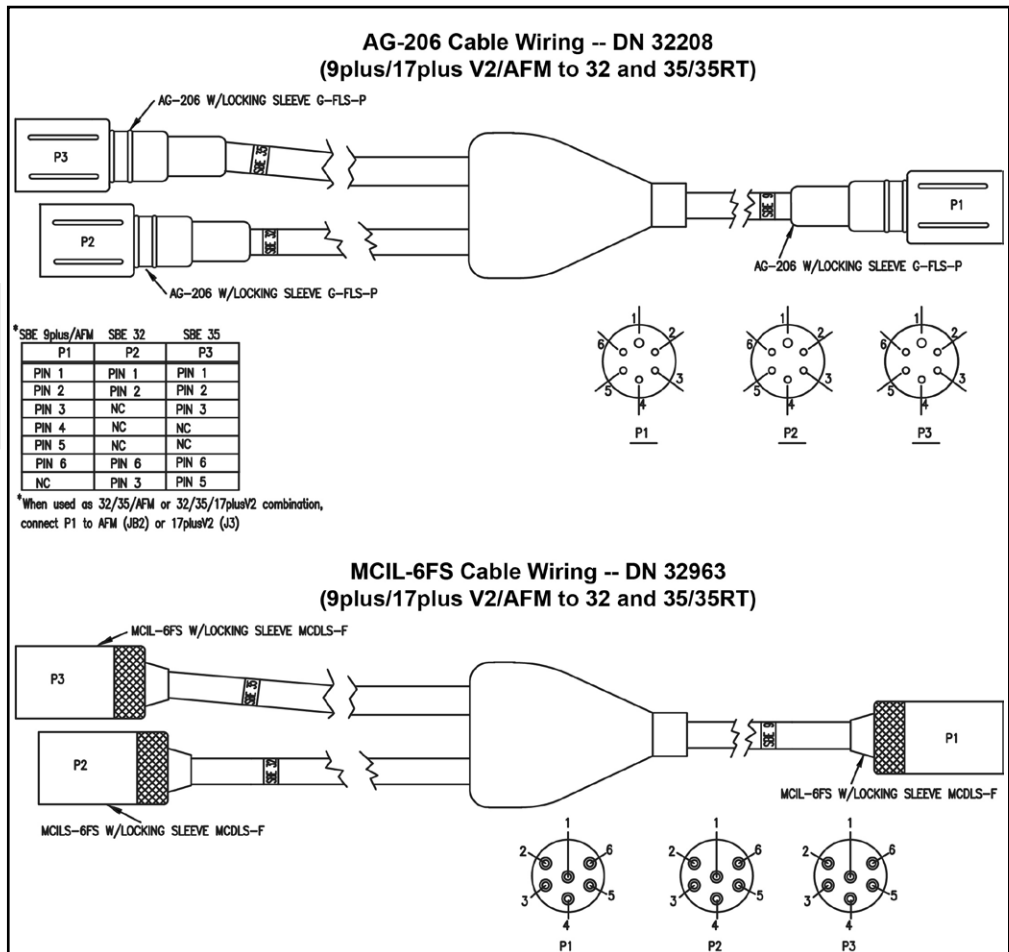

Section 3: Preparing for Deployment

This section describes software installation, testing and setting up the SBE 35, commands, and data formats.

Software Installation

Seasoft V2 was designed to work with a PC running Windows XP service pack 2 or later, Windows Vista, or Windows 7 (32-bit or 64-bit).

If not already installed, install Sea-Bird software programs on your computer using the supplied software CD:

1. Insert the CD in your CD drive.
2. Install software: Double click on **SeasoftV2.exe**. Follow the dialog box directions to install the software. The installation program allows you to install the desired components. Install all the components, or just install Seaterm (terminal program), SeatermV2 (terminal program for use when directly communicating with an SBE *19plus* V2 or *25plus*), Seasave V7 (real-time data acquisition), and SBE Data Processing (data processing).

The default location for the software is c:\Program Files\Sea-Bird. Within that folder is a sub-directory for each program.

Notes:

- It is possible to use the SBE 35 without Seaterm by sending direct commands from a dumb terminal or terminal emulator, such as Windows HyperTerminal.
- Help files provide detailed information on the software.
- Separate software manuals on CD-ROM contain detailed information on the setup and use of the software.
- Sea-Bird supplies the current version of our software when you purchase an instrument. As software revisions occur, we post the revised software on our website. See our website for the latest software version number, a description of the software changes, and instructions for downloading the software.

Power and Communications Test

Test Setup

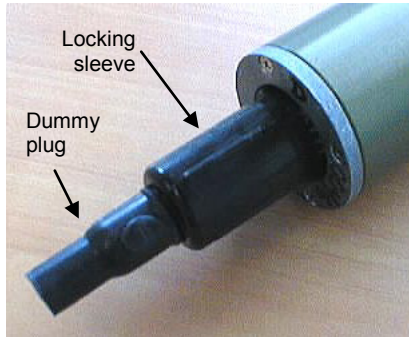

Test power and communications by communicating with the SBE 35 through the Interface Box:

1. By hand, unscrew the locking sleeve from the SBE 35's bulkhead connector. **If you must use a wrench or pliers, be careful not to loosen the bulkhead connector instead of the locking sleeve.**
2. Remove the dummy plug from the SBE 35's bulkhead connector by pulling the plug firmly away from the connector.
3. **AG Connector** - Install the supplied I/O cable on the SBE 35, aligning the raised bump on the side of the plug/cable connector with the large pin (pin 1 - ground) on the SBE 35. **OR**
MCBH Connector – Install the supplied I/O cable on the SBE 35, aligning the pins.
4. Connect the I/O cable to *SBE 35* on the Interface Box.
5. Connect *RS-232* on the Interface Box to your computer's serial port using the supplied DB 9P / DB 9S cable.
6. Connect the Interface Box to a standard, 3-prong, grounded AC outlet, using the supplied UL/IEC-approved power cord (AC voltage between 100-240 VAC). Turn on power to the Interface Box.

Test

Note:
See Seaterm's help files.

Proceed as follows:

1. Double click on SeaTerm.exe. If this is the first time the program is used, the setup dialog box may appear:



Select the instrument type (*SBE 35*) and the computer COM port for communication with the SBE 35. Click OK.

2. The main screen looks like this:

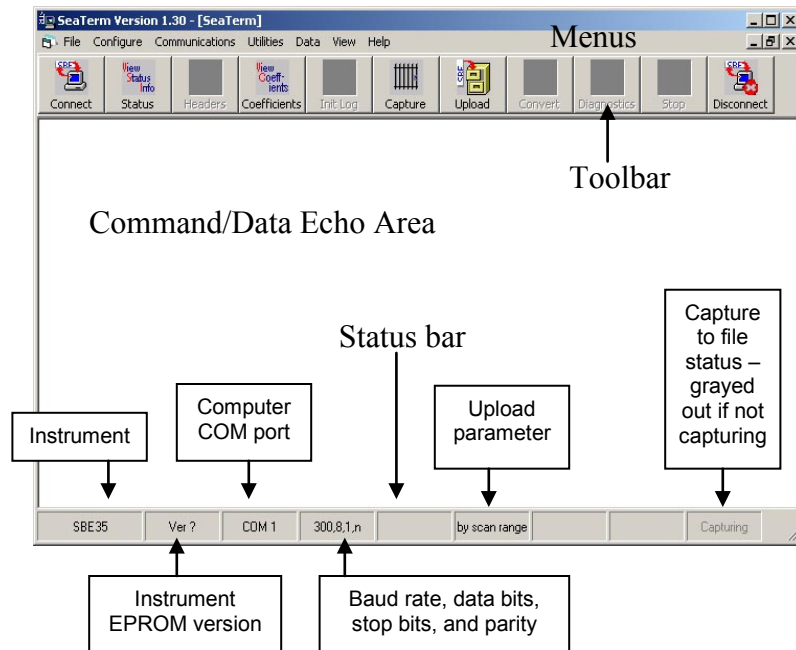

Note:

There is at least one way, and as many as three ways, to enter a command:

- Manually type a command in Command/Data Echo Area
- Use a menu to automatically generate a command
- Use a Toolbar button to automatically generate a command

Note:

Once the system is configured and connected (Steps 3 and 4 below), to update the Status bar:

- on the Toolbar, click Status; or
- from the Utilities menu, select Instrument Status.

Seaterm sends the status command, which displays in the Command/Data Echo Area, and updates the Status bar.

- **Menus** – Contains tasks and frequently executed instrument commands.
- **Toolbar** – Contains buttons for frequently executed tasks and instrument commands. All tasks and commands accessed through the Toolbar are also available in the Menus. To display or hide the Toolbar, select View Toolbar in the View menu. Grayed out Toolbar buttons are not applicable.
- **Command/Data Echo Area** – Echoes a command executed using a Menu or Toolbar button, as well as the instrument's response. Additionally, a command can be manually typed in this area, from the available commands for the instrument. Note that the instrument must be *awake* for it to respond to a command (use Connect on the Toolbar to wake up the instrument when using it with the Interface Box).
- **Status bar** – Provides status information. To display or hide the Status bar, select View Status bar in the View menu.

Following are the Toolbar buttons applicable to the SBE 35:

Toolbar Button	Description	Equivalent Command*
Connect	Re-establish communications with SBE 35. Computer responds with S> prompt.	(press Enter key)
Status	Display instrument setup and status (number of measurements to take and average per sample, number of samples in memory, etc.).	DS
Coefficients	Display calibration coefficients.	DC
Capture	Capture instrument responses on screen to file. File has .cap extension. Press Capture again to turn off capture. Capture status displays in Status bar.	—
Upload	Upload data stored in SBE 35's memory, along with status, calibration coefficient, and user-input header information. Uploaded file has .asc extension. Before using Upload: <ul style="list-style-type: none"> • Configure upload and header parameters in Configure menu. • Remove power to stop sampling. 	DDb,e (use Upload to include status, calibration coefficient and user-input header information in file)
Disconnect	Free computer COM port used to communicate with SBE 35. COM port can then be used by another program.	—

*See *Command Descriptions* in this section.

3. In the Configure menu, select *SBE 35*. The dialog box looks like this:

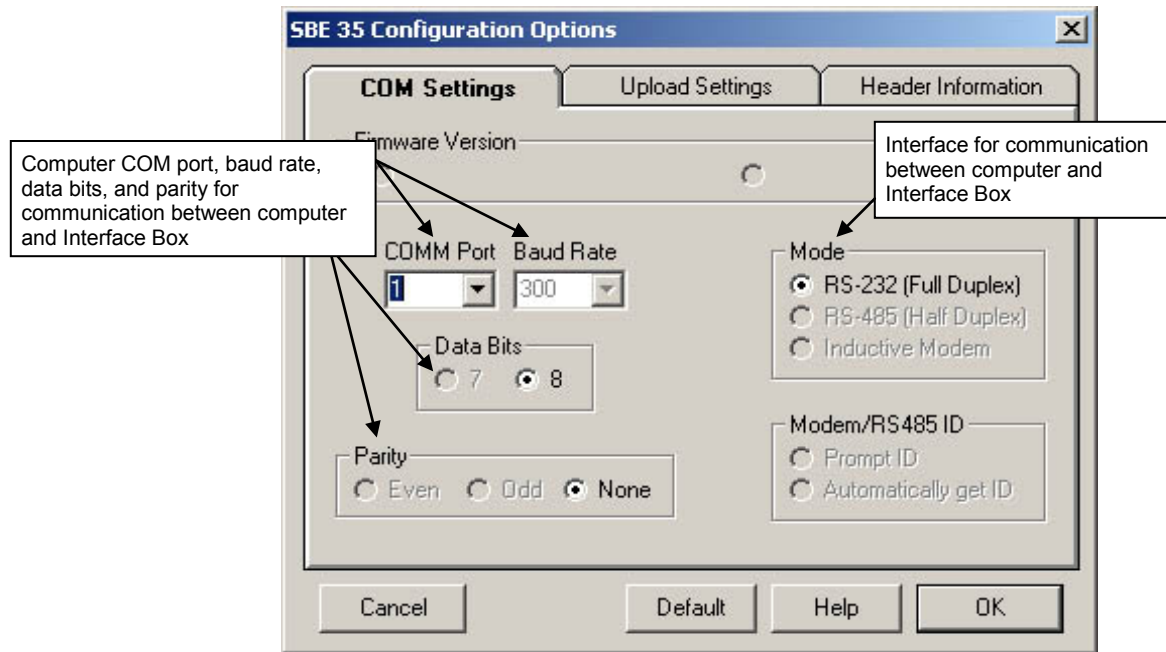
**Note:**

When you click OK, Seaterm saves the Configuration Options settings to the SeaTerm.ini file in your Windows directory. SeaTerm.ini contains the last saved settings for each instrument (SBE 35, 37, etc.). When you open Seaterm and select the desired instrument in the Configure menu, the Configuration Options dialog box shows the last saved settings for that instrument.

Make the selections in the Configuration Options dialog box:

- **COMM Port:** COM 1 through COM 10, as applicable
- **Baud Rate:** 300
- **Data Bits:** 8
- **Parity:** None
- **Mode:** RS-232 (Full Duplex)

Click OK to save the settings.

4. Click Connect on the Toolbar. The display looks like this:

```
S>
```

This shows that correct communications between the computer and the SBE 35 has been established.

If the system does not respond as shown above:

- Click Connect again.
- Verify the correct instrument was selected in the Configure menu and the COM setting was entered correctly in the Configuration Options dialog box. Note that the baud rate's factory setting is documented on the front cover of this manual.
- Check cabling between the computer, Interface Box, and SBE 35.

5. Display SBE 35 status information by clicking Status on the Toolbar. The display looks like this:

```
SBE 35 V 2.0a SERIAL NO. 0013 07 Dec 2012 08:49:08
number of measurement cycles to average = 8
number of data points stored in memory = 2
bottle confirm interface = SBE 911plus
```

6. Command the SBE 35 to take a sample by typing **TS** and pressing the Enter key. The display looks like this:

```
197.20 1047481 289795.4 15 35 29 289955.4 22.654745
```

where

- 197.20 = average of raw **reference zero** readings taken during a measurement
- 1047481 = average of raw **reference resistor full scale** readings taken during a measurement
- 289795.4 = average of raw thermistor readings taken during a measurement
- 15 = (maximum – minimum) raw **reference zero** reading during a measurement (provides a measure of the amount of variation during the measurement)
- 35 = (maximum – minimum) raw **reference resistor full scale** reading during a measurement (provides a measure of the amount of variation during the measurement)
- 29 = (maximum – minimum) raw thermistor reading during a measurement (provides a measure of the amount of variation during the measurement)
- 289955.4 = average raw thermistor reading, corrected for *zero* and *full scale* reference readings
- 22.654745 = average corrected raw thermistor reading, converted to engineering units (°C [ITS-90])

These numbers should be reasonable; i.e., the thermistor should be reading room temperature.

The SBE 35 is ready for programming and deployment.

Note:

See *Data Formats* for detailed descriptions of each output parameter.

Command Descriptions

This section describes commands and provides sample outputs.
See *Appendix III: Command Summary* for a summarized command list.

When entering commands:

Note:

***rtctest** and ***eetest** are case sensitive, and must be entered as shown. All other commands can be entered in upper or lower case.

- Input commands to the SBE 35 in upper or lower case letters and register commands by pressing the Enter key.
- The SBE 35 sends ? CMD if an invalid command is entered.
- If the system does not return an S> prompt after executing a command, press the Enter key to get the S> prompt.
- Establish communications by clicking Connect on the Toolbar or pressing the Enter key to get an S> prompt.

Status Command

DS

Display setup parameters.
Equivalent to Status on Toolbar.

List below includes, where applicable, command used to modify parameter.

- firmware version, serial number, date and time [**MMDDYY=** and **HHMMSS=**]
- number of measurements to take and average per sample [**NCycles=**]
- number of samples in memory [**SampleNum=**]
- interface for use with SBE 32 Carousel Water Sampler [**Interface=**] – *SBE 911plus* (for use with SBE *9plus* CTD, SBE *11plus* Deck Unit, and SBE 32 Carousel Water Sampler)
or
SBE 32 with serial interface (for use with SBE 19, *19plus*, *19plus* V2, 25, or *25plus* CTD; SBE 33 Deck Unit; and SBE 32 Carousel Water Sampler)

Example: Display status for SBE 35 (user input in bold).

S>**DS**

SBE 35 V 2.0a SERIAL NO. 0013 07 Dec 2012 08:49:08
number of measurement cycles to average = 8
number of data points stored in memory = 2
bottle confirm interface = SBE 911plus

[**MMDDYY=** and **HHMMSS=**]
[**NCycles=**]
[**SampleNum=**]
[**Interface=**]

Setup Commands

Notes:

- **DDMMYY=** and **MMDDYY=** are equivalent. Either can be used to set the date.
- **Always set date and then time.** If a new date is entered but not a new time, the new date will not be saved. If a new time is entered without first entering a new date, the date will reset to the last date it was set for with **MMDDYY=** or **DDMMYY=**.

MMDDYY=mmddySet real-time clock month, day, year. Must be followed by **HHMMSS=** to set time.**DDMMYY=ddmmyy**Set real-time clock day, month, year. Must be followed by **HHMMSS=** to set time.**HHMMSS=hhmmss**

Set real-time clock hour, minute, second.

Example: Set current date and time to 10 January 2014 12:00:00 (user input in bold).

S>**MMDDYY=011014**S>**HHMMSS=120000**

or

S>**DDMMYY=100114**S>**HHMMSS=120000****Note:**

See *Data Formats* for more details on how **NCycles** affects the measurement.

NCycles=x

x= number of measurements to take and average per sample (1 – 127). Time required for each measurement is 1.1 seconds; therefore, total time for each sample is (1.1 seconds * **NCycles**). Averaged data is stored in EEPROM and/or transmitted real-time, depending on sampling mode.

In a thermally quiet environment, temperature noise standard deviation is: $0.000029 * \sqrt{8 / \text{NCycles}}$ (°C)

Interface=x

x=911plus: SBE 35 used with SBE 9*plus* CTD, SBE 11*plus* Deck Unit, and SBE 32 Carousel Water Sampler.

x=32serial: SBE 35 used with SBE 19, 19*plus*, 19*plus* V2, 25, or 25*plus* CTD; SBE 33 Carousel Deck Unit; and SBE 32 Carousel Water Sampler.

Note:

SampleNum=0 does not delete data; it just resets the data pointer. **If you accidentally send this command before uploading, recover data as follows:**

1. Set **SampleNum=a**, where **a** is your estimate of number of samples in memory.
2. Upload data. If **a** is more than actual number of samples, data for non-existent samples will be bad, random data. Review uploaded data file carefully and delete any bad data.
3. If desired, increase **a** and upload data again, to see if there is additional valid data in memory.

SampleNum=x

x= sample number for first sample when sampling begins. After all previous data has been uploaded from SBE 35, set sample number to 0 before starting to sample again to make entire memory available for recording. If **SampleNum** is not reset to 0, data will be stored after last recorded sample.
SBE 35 can store up to 179 samples.

Sampling Commands

The SBE 35 samples when commanded by the user (**Cal**, **Run**, or **TS**), or *automatically* upon receipt of a valid bottle fire confirmation sequence (when used with an SBE 32 Carousel Water Sampler).

- When the SBE 35 receives a valid bottle fire confirmation sequence (a character with decimal value 6 followed by a character with decimal value greater than 48 and less than 84), it takes a measurement **NCycles** in duration and stores the data in EEPROM.

Notes:

- Data format varies, depending on the sampling command. See *Data Formats* after these *Command Descriptions*.
- To capture real-time data from **Cal**, **Run**, or **TS** to a file, do this *before* starting sampling:
 - A. Click Capture on Toolbar.
 - B. Enter desired file name in dialog box. *Capture* status displays in status bar at bottom of screen.

Cal

Start data sampling continuously now, outputting real-time raw data. Data is not stored in EEPROM. To stop sampling, press Esc key or type Ctrl C, and then press Enter key.

Time from start of one sample to start of next is:

$[(1.1 * \mathbf{NCycles}) + 2.7]$ seconds

The 2.7 seconds is required for transmitting real-time data.

Run

Start data sampling continuously now, outputting real-time raw data as well as computed temperature (°C). Data is not stored in EEPROM. To stop sampling, press Esc key or type Ctrl C, and then press Enter key.

Time from start of one sample to start of next is:

$[(1.1 * \mathbf{NCycles}) + 2.7]$ seconds

The 2.7 seconds is required for converting measured values to computed temperature and transmitting real-time data.

TS

Take one sample (consisting of **NCycles** measurements), store average in EEPROM, and transmit average real-time.

Notes:

- To save data to a file, click Capture on the Toolbar before entering **DDb,e**.
- See *Data Formats* after these *Command Descriptions*.
- **Use Upload on the Toolbar or Upload Data in the Data menu to write SBE 35 setup, calibration coefficients, and a user-input header along with uploaded data to a .asc file.**

Data Upload Command

DDb,e

Upload data from memory, from sample **b** to sample **e**. First sample is number 1. If **DD** is sent, all samples are uploaded.

Examples: Upload data from EEPROM (user input in bold):
(Click Capture on Toolbar and enter desired filename in dialog box before beginning upload.)

S>**DD1, 16** (Upload scans 1 through 16)

S>**DD1, 1** (Upload scan 1)

S>**DD** (Upload all scans in memory)

Testing Commands

Note:

***rtctest** and ***eetest** are case sensitive, and must be entered as shown.

***rtctest**

Test battery-backed static RAM in real-time clock module. **Test resets date and time to default (01 Jan 1980 00:00:00)**, but does not reset other setup parameters or destroy sampling data in memory. SBE 35 requires you to enter command twice, to provide verification before it proceeds.

***eetest**

Test EEPROM memory. Allow 30 seconds for test. **Test destroys all sampling data and setup parameters** (calibration coefficients, **NCycles**, etc.) stored in EEPROM. SBE 35 requires you to enter command twice, to provide verification before it proceeds.

Calibration Coefficients Commands

Notes:

- Date shown is when calibration was performed. Calibration coefficients are initially factory-set and should agree with Calibration Certificate shipped with SBE 35.
- See individual Coefficient Commands below for definitions of the data in the example.

DC

Display calibration coefficients.
Equivalent to Coefficients on Toolbar.

Example: Display coefficients for SBE 35 (user input in bold).

```
S>DC
SBE35  V 2.0a  SERIAL NO. 0011
08-Dec-10
A0 = 5.156252707e-03
A1 = -1.430180396e-03
A2 = 2.092145355e-04
A3 = -1.156278215e-05
A4 = 2.446454055e-07
SLOPE = 1.000000
OFFSET = 0.000000
```

Note:

F = floating point number.
S = string with no spaces.

The individual Coefficient Commands listed below modify a particular coefficient or date:

CalDate=S

S=Temperature calibration date.

TA0=F

F=Temperature A0.

TA1=F

F=Temperature A1.

TA2=F

F=Temperature A2.

TA3=F

F=Temperature A3.

TA4=F

F=Temperature A4.

Slope=F

F=Temperature calibration slope.

Offset=F

F=Temperature calibration offset.

Data Formats

Each sample consists of the following measurement scheme repeated **NCycles** times:

- Raw **reference zero** - Raw A/D reading of 16 samples with circuit ground switched in place of the thermistor.
- Raw **reference full scale** - Raw A/D reading of 16 samples with a hermetically sealed precision resistor switched in place of the thermistor.
- Raw **thermistor** - Raw A/D reading of 16 samples with the thermistor in the circuit.

For example, if **NCycles** is 8, the total number of readings is 128 (= 8 * 16) reference zero readings, 128 reference full scale readings, and 128 thermistor readings. The reported values are the simple average of the 128 readings. The (maximum – minimum) values are the maximum value read during the 128 readings minus the minimum value read during the 128 readings.

The average raw thermistor value, corrected for *zero* and *full scale* reference readings, is:

$$\frac{1048576 * (\text{raw thermistor average} - \text{raw reference resistor } \textit{zero} \text{ average})}{(\text{raw reference resistor } \textit{full scale} \text{ average} - \text{raw reference resistor } \textit{zero} \text{ average})}$$

Plugging this value into the calibration equation yields the computed temperature in engineering units (°C [ITS-90]).

Data Uploaded from EEPROM

Note:

For all data formats, each line of output is followed by a carriage return and line feed.

Data is placed in the SBE 35's EEPROM:

- Each time the SBE 35 receives a valid bottle fire confirmation sequence when used with the SBE 32 Carousel Water Sampler
- When the user sends **TS** (typically for lab use)

Data is uploaded (using Seaterm's Upload button or **DDb,e**) in the following format:

Column	Description
1	sample number
2	date (DD MMM YYYY – day, month, year). The month is a 3-character alphabetic abbreviation; e.g., jan, feb, mar, etc.)
3	time (HH:MM:SS – hour, minute, second)
4	bn = bottle position number (bottle position number is 0 if sample was taken in response to TS)
5	diff = (maximum – minimum) raw thermistor reading during a measurement (provides a measure of the amount of variation during the measurement)
6	val = average raw thermistor reading, corrected for <i>zero</i> and <i>full scale</i> reference readings
7	t90 = average corrected raw thermistor reading, converted to engineering units (°C [ITS-90])

Example: SBE 35 at room temperature (user input in bold)

S>**DD1,2**

```
1 06 Dec 2012 16:15:13 bn=8 diff=19 val=284583.3 t90=23.133510
2 06 Dec 2012 16:15:41 bn=6 diff=21 val=284568.0 t90=23.134886
```

Real-Time Data from Cal Command

When the user sends **Cal**, real-time data is output in the following format:

Column	Description
1	average of raw reference zero readings taken during a measurement
2	average of raw reference resistor full scale readings taken during a measurement
3	average of raw thermistor readings taken during a measurement
4	(maximum – minimum) raw reference zero reading during a measurement (provides a measure of the amount of variation during the measurement)
5	(maximum – minimum) raw reference resistor full scale reading during a measurement (provides a measure of the amount of variation during the measurement)
6	(maximum – minimum) raw thermistor reading during a measurement (provides a measure of the amount of variation during the measurement)
7	average raw thermistor reading, corrected for <i>zero</i> and <i>full scale</i> reference readings

Example: SBE 35 in a Triple Point of Water Cell (user input in bold)

S>**CAL**

197.21 1047557 752453.3 15 31 27 753130.0

197.87 1047563 752457.4 15 31 21 753129.0

197.64 1047565 752459.1 15 32 18 753129.5

Real-Time Data from Run or TS Command

When the user sends **Run** or **TS**, real-time data is output in the same format as for **Cal**, with the addition of an eighth column for average corrected raw thermistor reading, converted to engineering units (°C [ITS-90]).

Example: SBE 35 at room temperature (user input in bold)

S>**RUN**

197.64 1047488 269139.8 13 37 52 269275.4 24.556287

191.77 1047493 268895.0 12 35 57 269030.4 24.579808

197.12 1047501 268859.8 14 27 48 268988.9 24.583787

Section 4: Deploying and Operating SBE 35

Note:

Operation of an autonomous water sampler system (i.e., without conducting cable) with the SBE 35 is not detailed in this manual.

This section provides instructions for operating the SBE 35:

- With a CTD, Deck Unit, and SBE 32 Carousel Water Sampler – deployment, recovery, uploading data from the SBE 35, and comparing SBE 35 data to CTD data are discussed
- With a fixed-point cell in the lab

Operation with CTD, Deck Unit, and SBE 32 Carousel Water Sampler

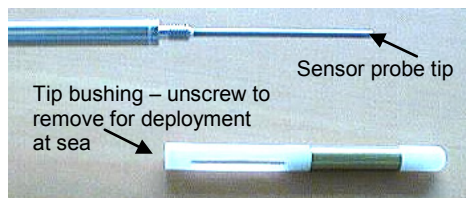

When used at sea, remove the tip bushing from the SBE 35 before deployment. Deployment with the tip bushing slows the SBE 35's response to changing temperature.

The SBE 35 can act as a stand-alone substitute for a reversing thermometer, recording temperature with each bottle closing. The SBE 35 is mounted in a secure area on the water sampler frame, where the water flushes freely and there is minimal contamination from the passive thermal mass of the metal frame or active thermal dissipation from electronic instruments. Data from the SBE 35 can be compared to the CTD's temperature sensor data; the best comparison measurements are expected in deep isothermal water. With good calibration locks of the SBE 35 in fixed-point cells before and after a cruise, the offset drift of an SBE 3 (temperature sensor on SBE *9plus*, *25*, and *25plus* CTDs) can be measured *in-situ* to a precision better than 0.0005 °C.

Note:

For details on creation of a .ros file, see *Comparing SBE 35 Data to CTD Data* below.

The SBE 35 has a time constant of 0.5 seconds, so it lags the SBE 3 if temperature is changing during the measurement interval. For a first order correction, determine the temporal gradient during the measurement interval from the SBE 3 temperature data in the .ros file:

gradient-corrected SBE 35 temperature = measured SBE 35 temperature + 0.5g

where

g = temperature gradient [°C/second]

Deployment with SBE 9*plus* CTD, SBE 11*plus* Deck Unit, and SBE 32 Carousel Water Sampler

Note:

For details on wiring, setup, and operation of the entire system, see the SBE 11*plus* manual. Only details relating to the use of the SBE 35 are covered here.

1. Mount the SBE 35 (**without** tip bushing, **with** sensor guard) in a secure area on the water sampler frame, where the water flushes freely and there is minimal contamination from the passive thermal mass of the metal frame or active thermal dissipation from electronic instruments.
2. Connect the SBE 35 to the SBE 9*plus* JT7 and SBE 32 Carousel Water Sampler JB2 using the Sea-Bird Y-cable (drawing 32208 for XSG / AG connectors on all three instruments; drawing 32963 for MCBH connector on all three instruments). The three arms of the cable are labeled *SBE 9*, *SBE 32*, and *SBE 35*. Connect each arm to the proper device. See *Connector Mating and Maintenance* in *Section 5: Routine Maintenance and Calibration* for information on lubricating and burping the connectors.
3. Turn on power to the SBE 11*plus* Deck Unit.
4. Double click on Seaterm.exe to verify communications and setup:
 - A. In the Configure menu, select *SBE 35*. Select the Com port that is connected to *Modem Channel* on the back of the SBE 11*plus* Deck Unit (the SBE 35 uses the modem channel for communications). Click OK.
 - B. Click Status on the Toolbar (**DS** command) to verify communication with the SBE 35 and check setup parameters. Change any parameters if desired (see *Command Descriptions* in *Section 3: Preparing for Deployment*), and resend the status command to verify the changes.
 - C. Ensure all data has been uploaded, and then type **SampleNum=0** and press the Enter key to make the entire memory available for recording. If **SampleNum** is not reset to zero, data will be stored after the last recorded sample.
 - D. Click Disconnect on the Toolbar to free the computer Com port.
 - E. Close Seaterm.
5. Double click on Seasave.exe to acquire the CTD cast:
 - A. Set up the system and display windows.
 - B. In the Real-Time Data menu, select *Start*. Make the desired selections in the Start Real-Time Data Acquisition dialog box, and then click the *Start* button.
 - C. Fire bottles as desired. Each time it receives a bottle confirmation, the SBE 35 takes a sample and stores the data in EEPROM. If the next bottle is fired before the SBE 35 finishes sampling (time required / sample = $1.1 * \mathbf{NCycles} + 2.7$ seconds), the SBE 35 ignores the next bottle confirmation.
 - D. When the cast is complete, in the Real-Time Data menu select *Stop*. Turn off power to the SBE 11*plus* Deck Unit.

Deployment with SBE 19, 19plus, 19plus V2, 25, or 25plus CTD; SBE 33 Deck Unit; and SBE 32 Carousel Water Sampler

1. Mount the SBE 35 (**without** tip bushing, **with** sensor guard) in a secure area on the water sampler frame, where the water flushes freely and there is minimal contamination from the passive thermal mass of the metal frame or active thermal dissipation from electronic instruments.
2. Connect the SBE 35 to the SBE 32 Carousel Water Sampler JB2 using the Sea-Bird cable (drawing 32209 for XSG / AG connectors on both instruments; drawing 32964 for MCBH connectors on both instruments). Connect the end labeled *SBE 35* to the SBE 35 and the end labeled *SBE 32* to the Carousel. See *Connector Mating and Maintenance* in *Section 5: Routine Maintenance and Calibration* for information on lubricating and burping the connectors.
3. Turn on power to the SBE 33 Deck Unit.
4. Double click on Seaterm.exe to verify communications and setup:
 - A. In the Configure menu, select *SBE 35*. Select the Com port that is connected to *Carousel Data* on the back of the SBE 33 Deck Unit (the SBE 35 uses the carousel data channel for communications). Click OK.
 - B. Click Status on the Toolbar (**DS** command) to verify communication with the SBE 35 and check setup parameters. Change any parameters if desired (see *Command Descriptions* in *Section 3: Preparing for Deployment*), and resend the status command to verify the changes.
 - C. Ensure all data has been uploaded, and then type **SampleNum=0** and press the Enter key to make the entire memory available for recording. If **SampleNum** is not reset to zero, data will be stored after the last recorded sample.
 - D. Click Disconnect on the Toolbar to free the computer Com port.
 - E. Close Seaterm.
5. Double click on Seasave.exe to acquire the CTD cast:
 - A. Set up the system and display windows.
 - B. In the Real-Time Data menu, select *Start*. Make the desired selections in the Start Real-Time Data Acquisition dialog box, and then click the *Start* button.
 - C. Fire bottles as desired. Each time it receives a bottle confirmation, the SBE 35 takes a sample and stores the data in EEPROM. If the next bottle is fired before the SBE 35 finishes sampling (time required / sample = $1.1 * \mathbf{NCycles} + 2.7$ seconds), the SBE 35 ignores the next bottle confirmation.
 - D. When the cast is complete, in the Real-Time Data menu select *Stop*. Turn off power to the SBE 33 Deck Unit.

Note:

For details on wiring, setup, and operation of the entire system, see the SBE 33 and the CTD manuals. Only details relating to the use of the SBE 35 are covered here.

Recovery

WARNING!

If the SBE 35 stops working while underwater, is unresponsive to commands, or shows other signs of flooding or damage, carefully secure it away from people until you have determined that abnormal internal pressure does not exist or has been relieved. Pressure housings

may flood under pressure due to dirty or damaged o-rings, or other failed seals. When a sealed pressure housing floods at great depths and is subsequently raised to the surface, water may be trapped at the pressure at which it entered the housing, presenting a danger if the housing is opened before relieving the internal pressure. Instances of such flooding are rare. However, a housing that floods at 5000 meters depth holds an internal pressure of more than 7000 psia, and has the potential to eject the end cap with lethal force. A housing that floods at 50 meters holds an internal pressure of more than 85 psia; this force could still cause injury.

If you suspect the SBE 35 is flooded, point the SBE 35 in a safe direction away from people, and loosen the bulkhead connector very slowly, at least 1 turn. This opens an o-ring seal under the connector. Look for signs of internal pressure (hissing or water leak). If internal pressure is detected, let it bleed off slowly past the connector o-ring. Then, you can safely remove the end cap.

Rinse the SBE 35 and the other underwater instruments with fresh water, and dry thoroughly.

Uploading Data from SBE 35

1. With the SBE 35 still connected to the system, turn on power to the Deck Unit.
2. Double click on SeaTerm.exe. The display shows the main screen.
3. In the Configure menu, select *SBE 35*. On the COM Settings tab, select the COM port that is connected to *Modem Channel* (SBE 11*plus* Deck Unit) or *Carousel Data* (SBE 33 Deck Unit), as applicable.
4. Click on the Upload Settings tab. The dialog box looks like this:

Note:

Set up **Upload Settings, Header Information, and/or Header Form** (Steps 4 through 6):

- The first time you upload data, and
- If you want to change upload or header parameters.

Baud for uploading data from SBE 35 to computer. For SBE 35, this is same as baud rate for general communication, 300 baud.

Defines data upload type when using Upload on Toolbar or Upload Data in Data menu:

- All as single file – All data uploaded into one file.
- By scan number range – Seaterm prompts for beginning and ending scan (sample) numbers, and uploads all data within range into one file.

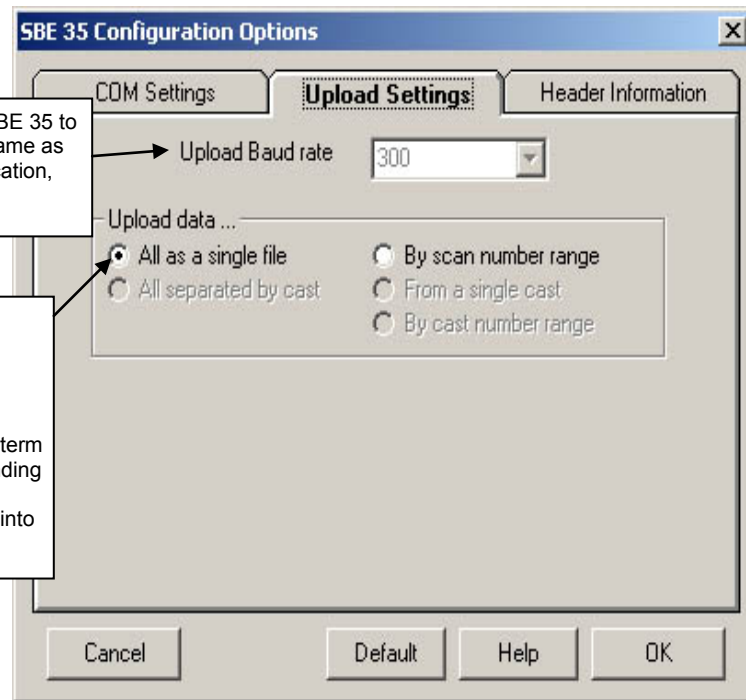

Make the selection for Upload Settings.

5. Click on the Header Information tab. The dialog box looks like this:

Defines header information included with uploaded data:

- Prompt for header information – Each time data is uploaded, user is prompted to fill out user-defined header form.
- Include default header form in upload file – User-defined default header form included in upload file. User is not prompted to add any information when data is uploaded.
- Don't include default header form in upload file – Header information not included in upload file.

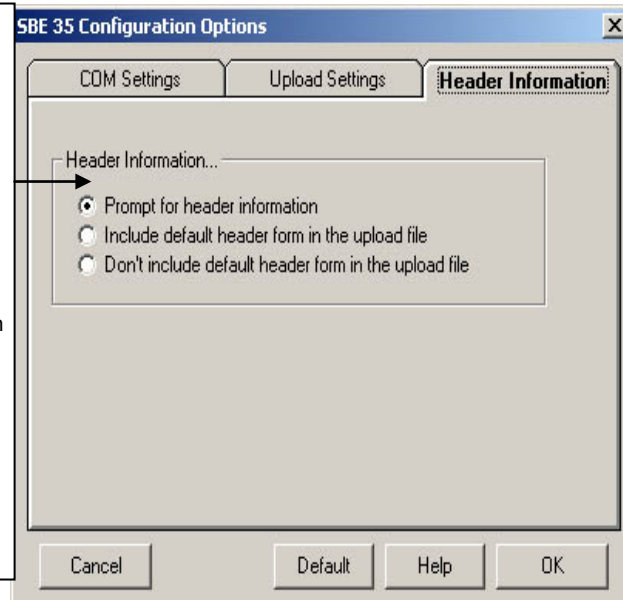

Select the desired option. Click OK to save the settings.

6. In the Configure menu, select Header Form to customize the header. The dialog box looks like this (default prompts are shown):

The entries are free form, 0 to 12 lines long. This dialog box establishes:

- the header prompts that appear for the user to fill in when uploading data, if *Prompt for header information* was selected in the Configuration Options dialog box (Step 5)
- the header included with the uploaded data, if *Include default header form in upload file* was selected in the Configuration Options dialog box (Step 5)

Enter the desired header/header prompts. Click OK.

7. Click Upload on the Toolbar to upload stored data from the SBE 35. Seaterm responds as follows:
- Seaterm sends the status (**DS**) command, displays the response, and writes the command and response to the upload file. This provides you with information regarding setup and number of samples in memory.
 - If you selected *By scan number range in the Configuration Options dialog box (Configure menu)*** – a dialog box requests the range. Enter the desired value(s), and click OK.
 - Seaterm sends the calibration coefficients (**DC**) command, displays the response, and writes the command and response to the upload file. This provides the calibration coefficients.
 - If you selected *Prompt for header information in the Configuration Options dialog box (Configure menu)*** – a dialog box with the header form appears. Enter the desired header information, and click OK.
 - In the Open dialog box, enter the desired upload file name and click OK. The upload file has a .asc extension.
 - Seaterm sends the data upload command (**DDb,e**).
 - When the data has been uploaded, Seaterm shows the *S>* prompt.
8. Ensure all data has been uploaded by reviewing the data.

Note:

To prepare for re-deployment: After all data has been uploaded, send **SampleNum=0**. If this command is not sent, new data will be stored after the last recorded sample, preventing use of the entire memory capacity.

Comparing SBE 35 Data to CTD Data

To compare the uploaded SBE 35 .asc data file to the CTD data file (.hex or .dat), process **the CTD data** in SBE Data Processing:

Notes:

- For complete details on use of SBE Data Processing, see the SBE Data Processing manual or Help files. Only details relating to the use of the SBE 35 are covered here.
- Seasave and SBE Data Processing versions 7.20a introduced .xmlcon files (in XML format). Versions 7.20a and later allow you to open a .con or .xmlcon file, and to save it to a .con or .xmlcon file. Seasave and SBE Data Processing use the same file.

1. Double click on SBEDataProc.exe.
2. Create a .ros bottle file, which contains CTD data for a user-selected range of scans before and after each bottle firing:
 - A. In SBE Data Processing's Run menu, select Data Conversion.
 - B. On the File Setup tab, select the configuration (.xmlcon or .con) file and data (.dat or .hex) file for your CTD.
 - C. On the Data Setup tab, set the following:
 - Create file types* = create both data and bottle file **or** bottle file only
 - Source of scan range data* = scans marked with bottle confirm bit
 - Scan range offset* = 0
 - Scan range duration* = 1.1 * **NCycles**
 - D. See the SBE Data Processing manual or Help files for selection of other parameters on the File Setup and Data Setup tabs.
 - E. Click Start Process. SBE Data Processing creates a .cnv file with all the CTD data (if *create both data and bottle file* was selected in Step 2C), and a .ros file with CTD data for the scans associated with each bottle.
3. Create a .btl bottle summary file, which contains averaged values as well as optional minimum, maximum, and standard deviation for each bottle:
 - A. In SBE Data Processing's Run menu, select Bottle Summary.
 - B. On the File Setup tab, select the configuration (.xmlcon or .con) and .ros file for your CTD.
 - C. On the Data Setup tab, set the following:
 - Output min/max values for averaged variables* – select to obtain minimum, maximum, and standard deviation for each parameter
 - Select Averaged Variables* – click to select parameters to process
 - Select Derived Variables* – click to select parameters to calculate from input parameters
 - D. Click Start Process. SBE Data Processing creates a .btl file with summary CTD data for the scans associated with each bottle firing.

Operation in Fixed-Point Cells

For calibration measurements in thermodynamic fixed-point cells, a brass and white plastic tip bushing is used to give the SBE 35 a length, diameter, and thermal averaging characteristic that mimics the standards-grade platinum resistance thermometer (SPRT).

1. Connect the SBE 35 to the Interface Box and the Interface Box to the computer using the supplied Sea-Bird cables. Turn on power to the Interface Box.
2. Double click on Seaterm.exe to verify communications and setup.
 - A. In the Configure menu, select SBE 35. In the Configuration Options dialog box, select the COM port that is connected to the Interface Box. Click OK.
 - B. Click Connect on the Toolbar; the *S>* prompt should display.
 - C. Click the Status button on the Toolbar (**DS** command) to verify communication with the SBE 35 and check setup parameters. Change any parameters if desired (see *Command Descriptions* in *Section 3: Preparing for Deployment*), and resend the status command to verify the changes.
3. Prepare the SBE 35:
 - A. Unscrew the sensor guard from the housing. Carefully remove the guard.
 - B. Unscrew the brass and white plastic tip bushing from the temperature sensor probe tip.
 - C. Using a syringe, fill the brass and white plastic tip bushing with the same thermal transfer fluid used in the fixed-point cell (for example, de-ionized water with 2% isopropyl alcohol). Fill the tip bushing from the bottom so that air bubbles are not trapped inside.
 - D. Screw the bushing onto the SBE 35 probe tip.
 - E. Adjust the SBE 35 probe temperature to $\leq 1^{\circ}\text{C}$ warmer than the fixed-point temperature to ensure the inner melt of the fixed-point cell is maintained.
 - F. Place the SBE 35 in the fixed-point cell.
4. In Seaterm:
 - A. Click Capture on the Toolbar to save data that appears on screen to a file with a .cap extension. The Open dialog box appears; enter the desired file name and location, and click Open.
 - B. Type **Run** and press the Enter key to start continuous sampling. The data appears on screen and is saved to the .cap file.
5. When done, remove power from the Interface Box.
6. Reinstall the sensor guard on the SBE 35.
7. Use a text editor (WordPad, NotePad, etc.) to extract the stable, converted data of interest from the .cap file.

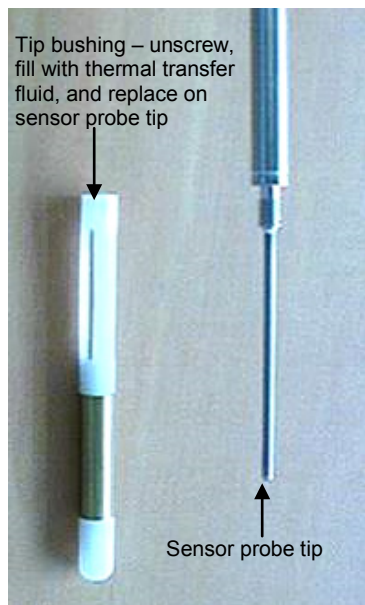

Section 5: Routine Maintenance and Calibration

This section reviews corrosion precautions, connector mating and maintenance, O-ring maintenance, and sensor calibration. The SBE 35's accuracy is sustained by the care and calibration of the sensors and by establishing proper handling practices.

Corrosion Precautions

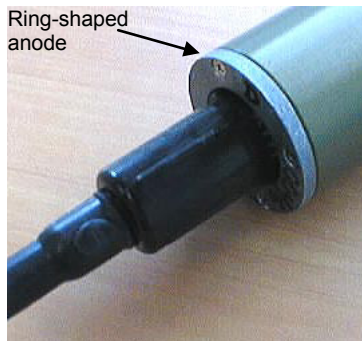

Rinse the SBE 35 with fresh water after use and prior to storage.

All stainless steel screws that are exposed to salt water have been generously lubricated with Blue Moly™. After each cruise, remove these screws and re-lubricate. **This compound is electrically conductive; use care to ensure it does not get on PCBs.**

A ring-shaped zinc anode is attached to the connector end of the SBE 35 housing. Check the anode periodically to verify that it is securely fastened and has not been eaten away.

Avoid direct attachment of metal objects to the housing.

Connector Mating and Maintenance

Note:

See *Application Note 57: Connector Care and Cable Installation*.

CAUTIONS:

- **Do not use WD-40** or other petroleum-based lubricants, as they will damage the connectors.
- For wet-pluggable MCBH connectors: **Silicone lubricants in a spray can** may contain ketones, esters, ethers, alcohols, or glycols in their propellant. **Do not use these sprays, as they will damage the connector.**

Clean and inspect connectors, cables, and dummy plugs before every deployment and as part of your yearly equipment maintenance. Inspect connectors that are unmated for signs of corrosion product around the pins, and for cuts, nicks or other flaws that may compromise the seal.

When remating:

1. Lightly lubricate the inside of the dummy plug/cable connector with silicone grease (DC-4 or equivalent).
2. **AG Connector** - Install the plug/cable connector, aligning the raised bump on the side of the plug/cable connector with the large pin (pin 1 - ground) on the SBE 35. Remove any trapped air by *burping* or gently squeezing the plug/connector near the top and moving your fingers toward the end cap. **OR**
MCBH Connector – Install the plug/cable connector, aligning the pins.
3. Place the locking sleeve over the plug/cable connector. Tighten the locking sleeve finger tight only. **Do not overtighten the locking sleeve and do not use a wrench or pliers.**

Verify that a cable or dummy plug is installed for each connector on the system before deployment.

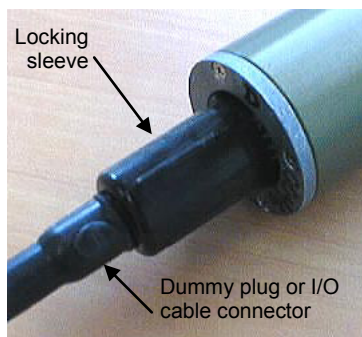

Cleaning Interface Box

To clean the Interface Box:

1. Disconnect the power and any other cables from the Interface Box.
2. Using a soft cotton cloth dampened with warm water, clean the exterior of the Interface Box with gentle pressure. Use special care cleaning around any connectors, to avoid getting water into them.
3. Wait until the Interface Box is completely dry before reconnecting power cables and other electrical connections.

O-Ring Maintenance

Note:

For details on recommended practices for cleaning, handling, lubricating, and installing O-rings, see the *Basic Maintenance of Sea-Bird Equipment* module in the Sea-Bird training materials on our website.

Recommended inspection and replacement schedule:

- SBE 35's O-rings are not normally disturbed. We recommend inspection and replacement approximately every 3 to 5 years.

Remove any water from the O-rings and mating surfaces in the housing with a lint-free cloth or tissue. Inspect O-rings and mating surfaces for dirt, nicks, and cuts. Clean or replace as necessary. Apply a light coat of O-ring lubricant (Parker Super O Lube) to O-rings and mating surfaces.

CAUTION:

Do not use Parker O-Lube, which is petroleum based; use only Super O-Lube.

Calibration

Calibration Introduction

The first calibration step is to characterize and capture the non-linear resistance vs temperature response of the sensor. Because it is important that *fit* equations reflect underlying physical mechanisms, the Steinhart-Hart equation is a good choice. By including terms through fourth order, this equation characterizes the SBE 35 output to an error less than ± 0.0001 °C (Figure 1). For SPRTs, the basic non-linear calibration equation has fixed coefficients that apply to all thermometers. However, thermistors require individualized coefficients to the Steinhart-Hart equation because, unlike pure SPRT platinum, the thermistor material is an individualized mix of dopants. The individualized SBE 35 calibrations are performed at Sea-Bird in a low-gradient temperature bath and against ITS-90 certified SPRTs maintained at Sea-Bird's primary temperature metrology laboratory. The calibration process is described below.

The second calibration step is frequent certification of the SBE 35 sensor by measurements in thermodynamic fixed-point cells. Triple Point of Water (TPW) and Gallium Melt Point (GaMP) cells are appropriate for the SBE 35, which is designed for ocean range temperatures (-5 to 35 °C). Like SPRTs, the slow time drift of the SBE 35 is adjusted by a slope and offset correction to the basic non-linear calibration equation.

Temperature Standards

The Sea-Bird primary temperature standard consists of two Yellow Springs Instruments standards-grade platinum resistance thermometers (YSI-8163Q S/N 4747, 4749) maintained and used exclusively in the temperature range -5 to 40 °C. SPRT resistance ratios are measured with an Automated Systems Laboratory ASL-F18 resistance bridge using methodology of the US National Institute of Standards and Technology (NIST) Primary Temperature Standards Laboratory. The SPRTs are calibrated and certified against a group of four Triple Point of Water cells (Jarrett S/N 461, 716, 1682, 1683) and one Gallium Melt Point cell (Isotech S/N 114). A second Gallium Melt Point cell is also periodically used for intercomparison.

Following NIST methodology, the TPW cell mantles are prepared and stress-annealed for two weeks before use. The cells are maintained in a temperature bath held at +0.008 °C, where they are used for several months before the mantles must be melted and rebuilt. The thermal transfer fluid used in the cell thermometer wells and maintenance bath is de-ionized water with 2% isopropyl alcohol, and a brass bushing (5 cm length) is used to couple the SPRT to the TPW thermometer well wall.

The Gallium Melt Point cells are cycled through a 100% melt in a commercial Isotech gallium furnace. De-ionized water and a brass bushing are used as the thermal transfer media in the thermometer well. The inner melt of the gallium ingot is initiated by injecting 58 °C de-ionized water into the thermometer well; thermometers are pre-heated to above 30 °C before insertion to insure the inner melt is preserved.

Our June 1995 calibration checks of SPRT S/N 4747 (used to calibrate the SBE 35) show it to be within ± 0.000050 °C of ITS-90. We expect SPRT readings at 15 °C to be within ± 0.000100 °C of ITS-90.

SBE 35 Linearization Calibration

The SBE 35 obtains its linearization calibration in a bath used to calibrate the Sea-Bird temperature transfer standards to our SPRTs. The computer-controlled, highly insulated, 50-liter volume bath is stirred and mixed to obtain temperature uniformity of better than ± 0.000250 °C. Calibrations are made at 11 points equally spaced from -1.5 to 32.5 °C. At each point, the bath is allowed to equilibrate for one hour. When the computer determines that bath stability and variance are acceptable, a 600-second synchronous integration of data from all sensors is obtained and tested for conformance to high stability and variance criterion. The 600-second integrations are repeated until all data pass the test; the computer then moves the bath to the next temperature point. Experiments indicate that the calibration transfer error from the SPRT to other sensors is within ± 0.000250 °C. The total accuracy of calibration is expected to be within ± 0.000500 °C.

The results of the SBE 35 calibration are shown in Figure 1. *Bath temperature* is obtained from the SPRT (S/N 4747). The Steinhart-Hart equation taken to fourth order fits the calibration data to within ± 0.000100 °C. While temperatures are reported to micro-degree level, we believe the reliable resolution of temperature with this system is approximately ± 0.000025 °C.

The time-drift rate of the SBE 35 is expected to be less than ± 0.001 °C/year, based on bench tests of the circuit and our experience with the super-stable SP-60 thermistors in other Sea-Bird instruments (for example, SBE 16). It is possible that the initial drift of the sensor will exceed the anticipated limit for a few months due to manufacturing stresses placed on circuit components.

SBE 35 Fixed-Point Calibration (Slope and Offset)

As with SPRT methodology, the basic certification of the SBE 35 sensor is performed by calibration measurements in thermodynamic fixed-point cells.

The slope and offset terms are determined by placing the SBE 35 in TPW and GaMP cells after the SBE 35 has been linearized.

Note:

Set the slope to 1.0 (**Slope=**) and the offset to 0.0 (**Offset=**) before performing a fixed-point calibration.

Figure 2 shows data taken in a TPW cell. Figure 3 shows the GaMP curve. The reported temperatures are calculated using the 29-Jun-95 linearization, with slope set to 1.0 and offset set to 0.0, and the number of cycles to average (**NCycles=**) set to 16.

Described below is the calculation of the slope and offset from the fixed-point calibration data in Figures 2 and 3:

Triple Point of Water

Defined temperature ITS-90	0.010000 °C
Hydrostatic head effect	-0.0073 mdeg/cm

In our TPW cell, the hydrostatic head is -0.000198 °C, thus:

true measured temperature in TPW cell:
 $t_t = 0.010000 - 0.000198 = 0.009802 \text{ °C}$

and

actual measured temperature from SBE 35 in TPW cell:
 $m_t = 0.009626 \text{ °C}$

Gallium Melt Point

Defined temperature ITS-90	29.764600 °C
Hydrostatic head effect	-0.01165 mdeg / cm
Atmospheric pressure effect	-2.0µK / millibar

In our GaMP cell, the hydrostatic head is -0.000272 °C and the barometric pressure was approximately 1010 millibars, thus:

true measured temperature in GaMP cell:
 $t_g = 29.764600 - 0.000272 + 0.000007 = 29.764335 \text{ °C}$

and

actual measured temperature from SBE 35 in GaMP cell (using a 60-minute average beginning 8.5 hours into the melt cycle):
 $m_g = 29.764336 \text{ °C}$

Calculation of Slope and Offset

$$\text{slope} = (t_g - t_t) / (m_g - m_t) = (29.764335 - 0.009802) / (29.764336 - 0.009626) = 0.999994$$

$$\text{offset} = t_t - (\text{slope} * m_t) = 0.009802 - (0.999994 * 0.009626) = 0.000176$$

Program the new slope and offset into the SBE 35 using the **Slope=** and **Offset=** commands.

SEA-BIRD ELECTRONICS, INC.

1808 136th Place N.E., Bellevue, Washington 98005 USA
 Phone: (206) 643 - 9866 Fax: (206) 643 - 9954 Internet: seabird@seabird.com

SENSOR SERIAL NUMBER = 1
 CALIBRATION DATE: 29-jun-95

TEMPERATURE CALIBRATION DATA
 ITS-90 TEMPERATURE SCALE

SBE 35 COEFFICIENTS

a0 = 5.353396734e-03
 a1 = -1.486906682e-03
 a2 = 2.157446016e-04
 a3 = -1.191723910e-05
 a4 = 2.520670077e-07

BATH TEMP (ITS-90 °C)	INSTRUMENT OUTPUT: n	INST TEMP (ITS-90 °C)	RESIDUAL (ITS-90 °C)
-1.432584	802788.41	-1.432534	0.000050
1.072655	718708.32	1.072573	-0.000082
4.568224	617253.29	4.568205	-0.000019
8.166711	529182.82	8.166776	0.000065
11.596517	458145.25	11.596549	0.000032
15.156793	395526.94	15.156779	-0.000014
18.660757	343166.34	18.660709	-0.000048
22.156465	298608.23	22.156463	-0.000002
25.719453	259824.40	25.719441	-0.000012
29.132353	227964.82	29.132408	0.000055
32.668212	199568.37	32.668188	-0.000024

Temperature ITS-90 = $1 / \{ a_0 + a_1[\ln(n)] + a_2[\ln^2(n)] + a_3[\ln^3(n)] + a_4[\ln^4(n)] \} - 273.15$ (°C)

Residual = instrument temperature - bath temperature

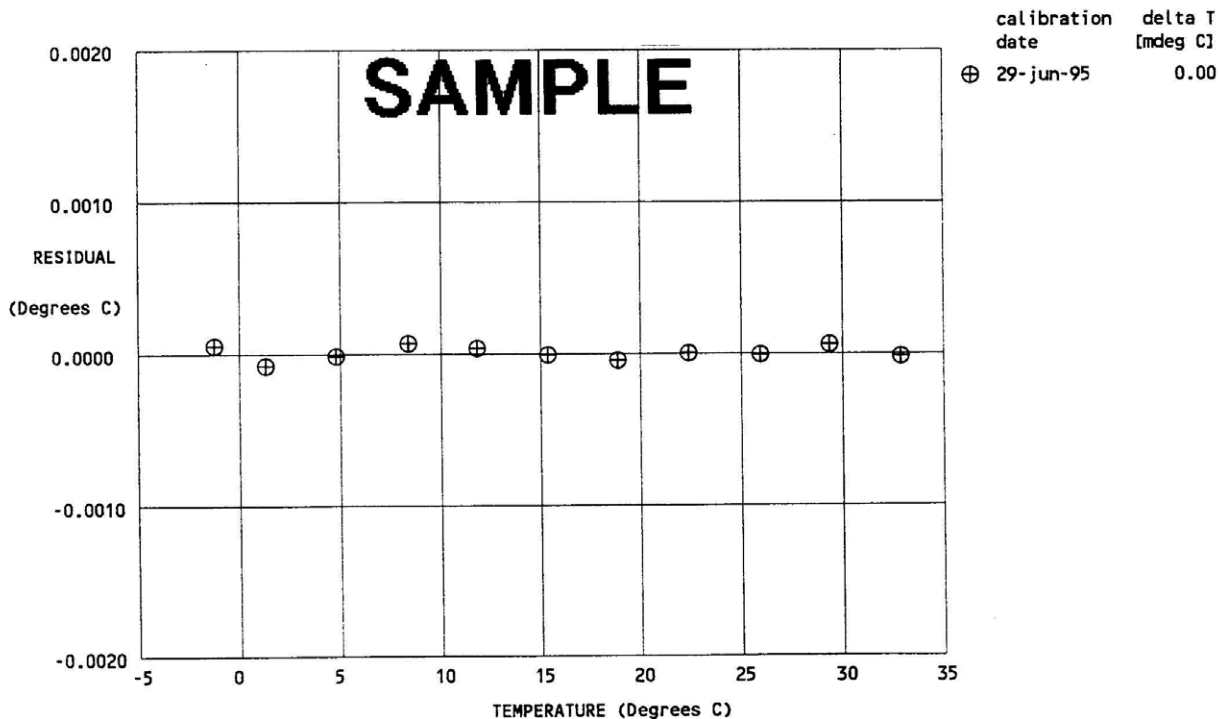
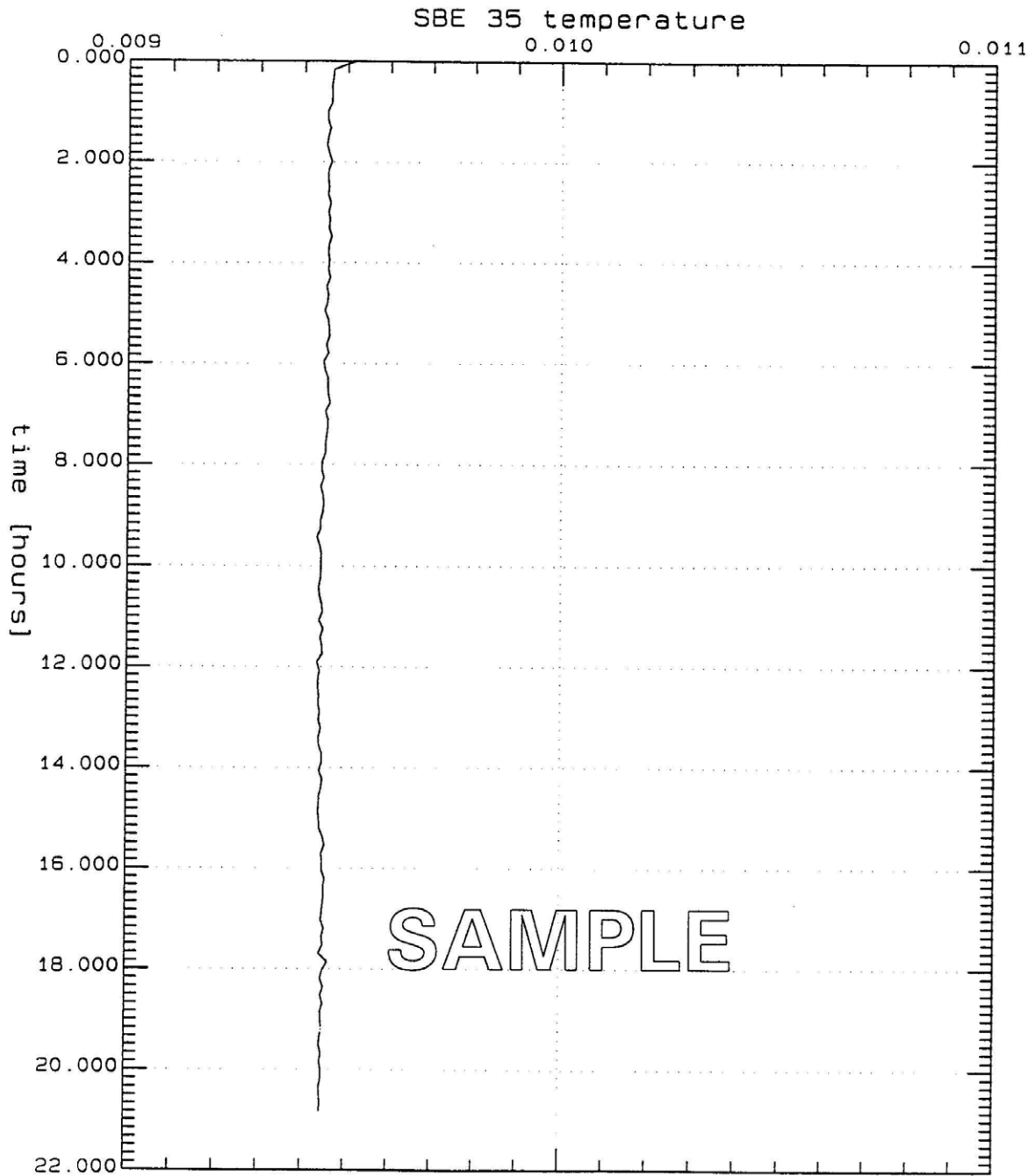

FIGURE 1

Sea-Bird calibration certificate for SBE 35 S/N 1. Coefficients are for the 29-Jun-95 calibration data. Bath temperatures were measured with Sea-Bird's SPRT (S/N 4747) calibrated 03 January 1995 and showing recent Triple Point of Water and Gallium Melt Point checks within ± 0.000050 of correct. We expect transfer errors in the bath to be within ± 0.000250 °C. Overall calibration accuracy is expected to be within ± 0.000500 °C.



TPW78A16.CNV: SBE 35 S/N 1 in TPW cell #1682, avg 16

48-hour time series measurements of SBE 35 S/N 1 in a TPW cell (TPW S/N Jarrett 1682). The TPW cell is maintained in a strain-annealed state in a stirred water bath at 0.008 °C. In the TPW thermometer well, the thermal transfer fluid is de-ionized water with 2% isopropyl alcohol, and a brass bushing of 5 cm length is used for good thermal contact between the measurement section of the SBE 35 (including its tip bushing) and the thermometer well wall. SBE 35 data were acquired with the 29-Jun-95 calibration coefficients and **NCycles=16**; the data set was further averaged with the Seasoft program Bin Average using bin=16 scans. Average measured temperature was 0.009626 °C.

FIGURE 2

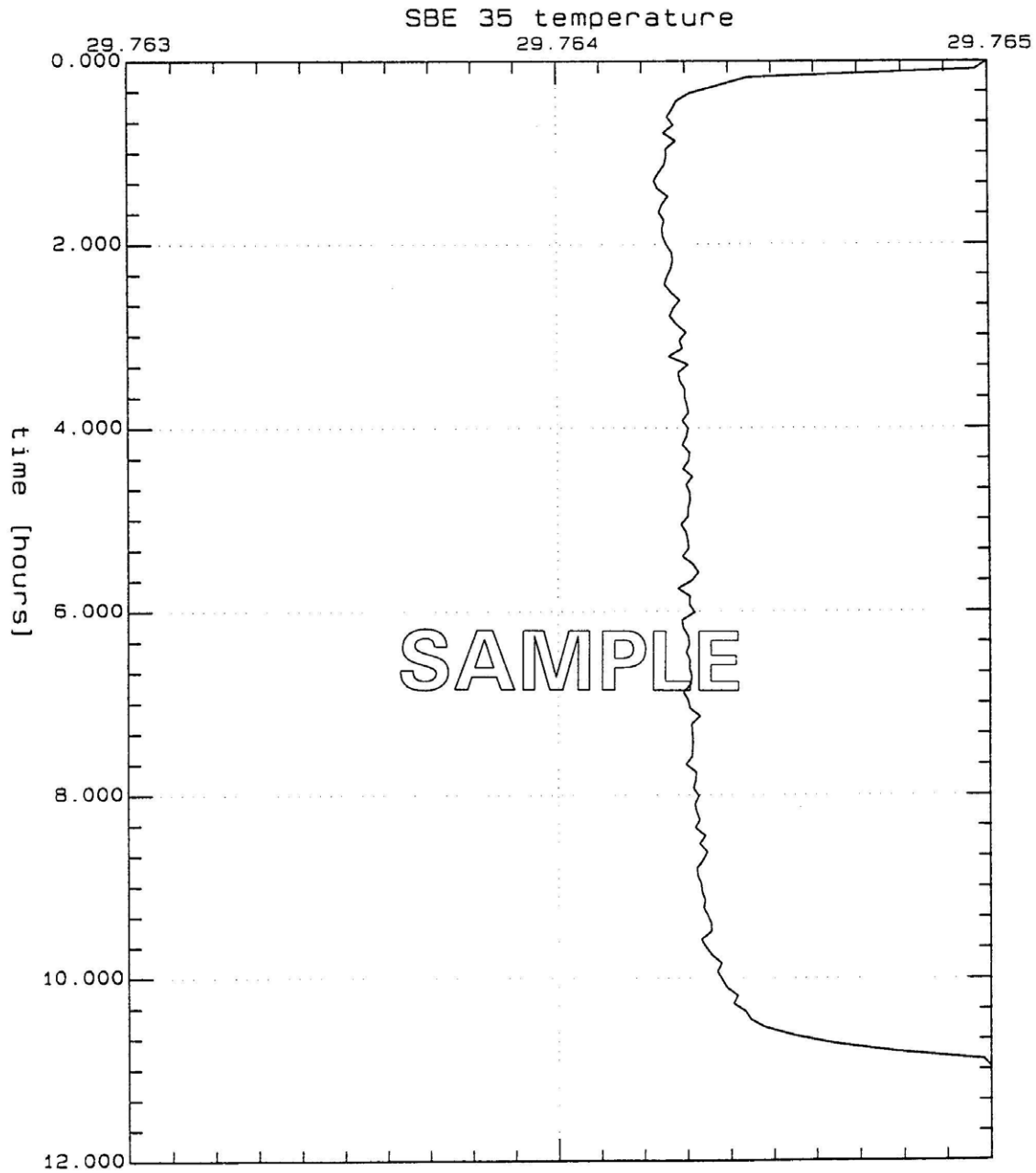

GAMP2A16.CNV: SBE 35 S/N 1 gallium melt

11-hour time series measurements of SBE 35 S/N 1 in a GaMP cell (GaMP s/n Isotech 114). The GaMP cell is melted in a Isotech gallium oven. The thermal transfer fluid is de-ionized water injected at a temperature of 58 °C to insure an inner melt. A thermometer well brass bushing is also used in the GaMP cell. The SBE 35 was inserted into the well at about 35 °C to preserve the inner gallium melt, and data were acquired with the 29-Jun-95 calibration coefficients and **NCycles=16**. Before plotting, the data were further averaged with the Seasoft module Bin Average using bin=16 scans. The melt plateau temperature is taken to be the average of temperatures on the upper plateau between hours 8.5 to 9.5 and is 29.764336 °C.

FIGURE 3

Glossary

Note:

All Sea-Bird software listed was designed to work with a computer running Windows XP service pack 2 or later, Windows Vista, or Windows 7 (32-bit or 64-bit).

PCB – Printed Circuit Board.

SBE 35 – High-accuracy deep ocean standards thermometer.

SBE Data Processing – Sea-Bird’s Windows data processing software, which calculates and plots conductivity, temperature, pressure, data from auxiliary sensors, and derived variables.

Scan – One data sample.

Seasave V7 – Sea-Bird’s Windows real-time data acquisition software, used to acquire, convert, and display real-time or archived raw data.

Seasoft V2 – Sea-Bird’s complete Windows software package, which includes software for communication, real-time data acquisition, and data analysis and display. Seasoft V2 includes **Seaterm**, **SeatermV2**, **Seasave V7**, **SBE Data Processing**.

Seaterm – Sea-Bird’s Windows terminal program used to communicate with:

- SBE 35
- SBE 19, *19plus*, or 25 CTD
- SBE *11plus* or 33 Deck Unit







SeatermV2 – Windows terminal program *launcher*. Depending on the instrument selected, it launches **Seaterm232** (RS-232 instruments), **Seaterm485** (RS-485 instruments), or **SeatermIM** (inductive modem instruments). **SeatermV2** is used to communicate with SBE *19plus V2* or *25plus* CTD.

Seaterm232 – Windows terminal program used with Sea-Bird instruments that communicate via an RS-232 interface, and that were developed or redesigned in 2006 and later. The common feature of these instruments is the ability to output data in XML.

SeatermAF V2 – Windows software used to communicate with Sea-Bird instruments with auto-fire capability, such as SBE *17plus V2* or AFM.

Safety and Electrical Symbols

Some or all of the following symbols may be used on the Interface Box:

Symbol	Description
	Potentially hazardous voltage.
	Hazardous! Voltage > 30 VDC may be present.
	Attention! There is a potential hazard; consult the manual before continuing.
	DC (Direct Current).
	Double insulated. The metal enclosure of the Interface Box is isolated such that protection from electrical shock is provided through reinforced electrical insulation.
	Static awareness. Static discharge can damage part(s).
	Protective earthing terminal.

Appendix I: Functional Description

Measurement Cycle

The SBE 35 determines temperature by applying a 1.2 kHz AC excitation to a reference resistor, zero ohms, and an ultrastable thermistor and digitizing the output from each with a 20-bit delta-sigma A/D converter. The reference resistor is a hermetically sealed VISHAY VHP202K inside a temperature-controlled oven. The switches are *All-Position* mercury wetted reed relays with a stable contact resistance. AC excitation and ratiometric comparison using a common processing channel removes measurement errors due to parasitic thermocouples, offset voltages, leakage currents, and gain errors. Maximum power dissipated in the thermistor is 5×10^{-7} watts.

$$\text{Sensor output} = 1048576 * (NT - NZ) / (NR - NZ)$$

where

NR = output from the reference resistor

NZ = output from zero ohms

NT = output from the thermistor

The process for each acquisition cycle is:

1. Select zero ohms, wait 0.1 seconds for the output to stabilize.
2. Average for 0.267 seconds; this is NZ.
3. Select reference resistor, wait 0.1 seconds for the output to stabilize.
4. Average for 0.267 seconds; this is NR.
5. Select thermistor, wait 0.1 seconds for the output to stabilize.
6. Average for 0.267 seconds; this is NT.

The total time per cycle is 1.1 seconds.

The number of acquisition cycles per sample is user-programmable (**NCycles**). Increasing the number of cycles per sample increases the time to acquire the sample, while reducing the RMS temperature noise from the sensor. The following RMS noise values are typical for an SBE 35 in a Triple Point of Water cell:

NCycles	Acquisition Time	Standard Deviation (°C)
8	8.8 seconds	0.000029
32	35.2 seconds	0.000014

Temperature is computed using the Steinhart-Hart polynomial for thermistors (Steinhart and Hart, 1968; Bennett, 1972) as follows (n = output from SBE 35):

$$t_{90L} = \frac{1.0}{a0 + a1 \ln(n) + a2 \ln^2(n) + a3 \ln^3(n) + a4 \ln^4(n)} - 273.15$$

$$t_{90} = \text{slope} * t_{90L} + \text{offset} \quad [^{\circ}\text{C}, \text{ITS-90}]$$

Carrying the polynomial to the fourth order captures the non-linearity of the SBE 35 thermistor output to better than ± 0.0001 °C. (See Figure 1 in *Section 5: Routine Maintenance and Calibration*).

Real-Time Clock

A low power *watch* crystal is used as the real-time-clock frequency source.

Memory

Data

The SBE 35 stores up to 179 samples in EEPROM. EEPROM memory is non-volatile, and data in the memory is not lost as a result of removal of external power.

Timekeeping

Time is stored in the real-time clock with a back-up lithium battery. Time is kept when external power is removed.

Settings

Calibration coefficients and setup and operating parameters (**SampleNum**, **NCycles**, etc.) are written to EEPROM and are non-volatile. These settings do not change if external power is removed.

Appendix II: Electronics Disassembly/Reassembly

Disassembly

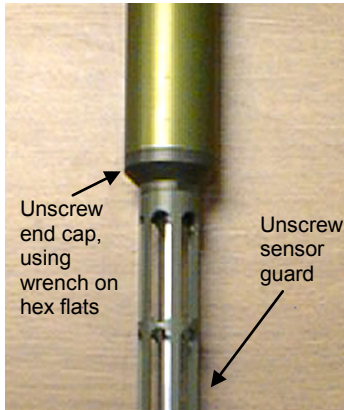

1. **As a precaution, before beginning:**
 - Upload any data in memory, and
 - Record the setup parameters from the **DS** command response.
2. Remove the sensor end cap and electronics:
 - A. Wipe the outside of the sensor end cap and housing dry, being careful to remove any water at the seam between them.
 - B. To access the hex flats for unscrewing the end cap, first unthread the sensor guard by rotating counter-clockwise. Carefully, remove the sensor guard.
 - C. Unthread the end cap by rotating counter-clockwise, using a wrench on the hex flats if necessary.
 - D. Slide the end cap and attached electronics out of the housing. Note that the electronics are electrically connected to the bulkhead connector.
 - E. Remove any water from the O-ring and mating surface inside the housing with a lint-free cloth or tissue.
 - F. Be careful to protect the sensor and O-ring from damage or contamination.

Reassembly

Note:

Before delivery, a desiccant package is placed in the housing, and the housing is filled with dry Argon gas. These measures help prevent condensation. To ensure proper functioning:

1. Install a new desiccant bag each time you open the housing. If a new bag is not available, see *Application Note 71: Desiccant Use and Regeneration (drying)*.
2. If possible, dry gas backfill each time you open the housing. If you cannot, wait at least 24 hours before redeploying, to allow the desiccant to remove any moisture from the housing.

1. Reinstall the sensor end cap and electronics:
 - A. Remove any water from the O-ring and mating surface in the housing with a lint-free cloth or tissue. Inspect the O-ring and mating surface for dirt, nicks, and cuts. Clean or replace as necessary. Apply a light coat of O-ring lubricant (Parker Super O Lube) to the O-ring and mating surface.
 - B. Carefully fit the end cap and electronics into the housing and rethread the end cap into place. Use a wrench on the hex flats to ensure the end cap is tightly secured.
 - C. Carefully fit the sensor guard over the sensor. Tighten the sensor guard. **Do not overtighten the sensor guard and do not use a wrench or pliers.**
2. Check the instrument setup using **DS** (see *Section 3: Preparing for Deployment*), and if necessary re-enter the desired parameters.

CAUTION:

Do not use Parker O-Lube, which is petroleum based; use only Super O-Lube.

Appendix III: Command Summary

Note:

See *Command Descriptions* in *Section 3: Preparing for Deployment* for detailed information and examples.

CATEGORY	COMMAND	DESCRIPTION
Status	DS	Display setup parameters.
Setup	MMDDYY= mmddy	Set real-time clock month, day, year. Must follow with HHMMSS=.
	DDMMYY= ddmmyy	Set real-time clock day, month, year. Must follow with HHMMSS=.
	HHMMSS= hhmmss	Set real-time clock hour, minute, second.
	NCycles=x	x= number of measurements to take and average per sample (1 – 127).
	Interface=x	x=911plus: SBE 35 used with SBE 9plus CTD, SBE 11plus Deck Unit, and SBE 32 Carousel Water Sampler. x=32serial: SBE 35 used with SBE 19, 19plus, 19plus V2, 25, or 25plus CTD; SBE 33 Carousel Deck Unit; and SBE 32 Carousel Water Sampler.
SampleNum=x	x= sample number for first sample when sampling begins. After all data has been uploaded, set to 0 before starting to sample to make entire memory available for recording. If not reset to 0, data stored after last sample.	
Sampling	Cal	Start sampling continuously now, outputting real-time raw data. Data not stored in EEPROM.
	Run	Start sampling continuously now, outputting real-time raw data as well as computed temperature (°C). Data not stored in EEPROM.
	TS	Take one sample; store in EEPROM and output real-time.
Data Upload	DDb,e	Upload data from sample b to e .
Testing (these commands are case sensitive, and must be entered as shown)	*rtctest	Test battery-backed static RAM in real-time clock module. Test resets date and time to default.
	*eetest	Test EEPROM memory. Allow 30 seconds for test. Test destroys all sampling data and setup parameters (calibration coefficients, etc.) stored in EEPROM.
Coefficients (F=floating point number; S=string with no spaces) Date shown is when calibration was performed. Calibration coefficients are initially factory-set and should agree with Calibration Certificate shipped with SBE 35.	DC	Display calibration coefficients; all coefficients and date listed below are included. Use individual commands below to modify a particular coefficient or date.
	CalDate=S	S=Temperature calibration date.
	TA0=F	F=Temperature A0.
	TA1=F	F=Temperature A1.
	TA2=F	F=Temperature A2.
	TA3=F	F=Temperature A3.
	TA4=F	F=Temperature A4.
	Slope=F	F=Temperature slope.
Offset=F	F=Temperature offset.	

Note:

Use Upload on the Toolbar or Upload Data in the Data menu to write SBE 35 setup, calibration coefficients, and a user-input header along with uploaded data to a .asc file.

Appendix IV: References

Steinhart, J.S. and Hart, S.R. (1968) "Calibration Curves for Thermistors", Deep-Sea Research, 15, p.497.

Bennett, A.S. (1972) "The Calibration of Thermistors over the Temperature range 0-30 °C", Deep-Sea Research, 19, p.157.

Appendix V: Replacement Parts

Part Number	Part	Application Description	Quantity in SBE 35
23929C	Aluminum temperature sensor guard	Screws to end cap to protect temperature sensor	1
90248	Interface Box	For lab use with SBE 35	1
171887	DB-9P to DB-9S I/O cable, 3.0 m (10 ft) long	Connect Interface Box to computer	1
17015	AC power cable	For Interface Box	1
80555	6-pin AG-206 to 4-pin MS3106A-14S-2P cable, 2.4 m (8 ft) long *	Connect SBE 35 to Interface Box	1
17047.1	6-pin AG-206 dummy plug with locking sleeve *	For SBE 35 connector	1
17043	Plastic locking sleeve *	For cable/dummy plug	1
171220	6-pin AG-206 to 6-pin AG-206 to 6-pin AG-206 Y-cable *	From SBE 35 to SBE 32 Carousel Water Sampler and: • SBE <i>9plus</i> CTD, • AFM, or • SBE <i>17plus</i> V2 Searam	-
171221	6-pin AG-206 to 6-pin AG-206 cable, 2.4 m (8 ft) long *	From SBE 35 to SBE 32 Carousel Water Sampler (for use with SBE 19, <i>19plus</i> , <i>19plus</i> V2, 25, or <i>25plus</i> CTD and SBE 33 Carousel Deck Unit)	-
801534	6-pin MCIL-6FS wet-pluggable connector to 4-pin MS3106A-14S-2P cable, 2.4 m (8 ft) long	Connect SBE 35 to Interface Box	1
171498.1	6-pin MCDC-6-F wet-pluggable dummy plug with locking sleeve	For SBE 35 connector	1
171192	Plastic locking sleeve for wet-pluggable connector	For cable/dummy plug	1
171995	6-pin MCIL-6FS to 6-pin MCIL-6FS to 6-pin MCIL-6FS (wet-pluggable) Y-cable	From SBE 35 to SBE 32 Carousel Water Sampler and: • SBE <i>9plus</i> CTD, • AFM, or • SBE <i>17plus</i> V2 Searam	-
171996	6-pin MCIL-6FS to 6-pin MCIL-6FS (wet-pluggable) cable, 2.4 m (8 ft) long	From SBE 35 to SBE 32 Carousel Water Sampler (for use with SBE 19, <i>19plus</i> , <i>19plus</i> V2, 25, or <i>25plus</i> CTD and SBE 33 Carousel Deck Unit)	-
23041	Anode ring	For corrosion resistance; connector end of housing	1
30126	4-40 x 3/8 flat head, stainless steel screws	Secure anode ring to housing	4
30806	LS021 L-seal	O-ring placed in end cap groove	1
50175	Fixed point cell bushing	Gives SBE 35 length, diameter, and averaging characteristic that mimics standards-grade platinum resistance thermometer (SPRT)	1
50225	Mount kit	For mounting SBE 35 on <i>9plus</i>	-

* For XSG / AG connectors

Appendix VI: Manual Revision History

Manual Version	Date	Description
006	12/02	<ul style="list-style-type: none"> • Rewrite
007	12/03	<ul style="list-style-type: none"> • Add wet-pluggable connector drawing. • Update Rosette Summary to Bottle Summary (change in SBE Data Processing). • Update Seaterm screens.
008	10/04	<ul style="list-style-type: none"> • Add wet-pluggable cable/plug equivalents. • Update part numbers.
009	03/07	<ul style="list-style-type: none"> • Incorporate Seasave V7. • Update wet-pluggable callout – switched to WB. • Update Recovery Warning. • Add information on maximum allowable value of Ncycles (127). • Update description of 171220 & 171995 Y-cables -- can also use for 35 to AFM/Carousel, & 35 to 17plus/Carousel. • Add more explanation of raw reference readings in Data Output Formats section.
010	02/09	<ul style="list-style-type: none"> • Correct maximum number of samples -- 179, not 170. • Update to include 19plus V2. • Add information about compatibility with Vista. • Add reference to SeatermV2. • Update connector maintenance information for consistency with application note 57.
011	11/10	<ul style="list-style-type: none"> • Redesign interface box and update manual to meet CE requirements. • Add information about .xmlcon configuration file. • Update address.
012	04/13	<ul style="list-style-type: none"> • Update to include SBE 25<i>plus</i>. • Add Declaration of Conformity. • Add cable wiring drawings. • Update software compatibility information. • Fix typos.
013	02/15	<ul style="list-style-type: none"> • Clarify that accuracy specifications are \pm. • Correct case for <i>*rtctest</i> and <i>*eetest</i> commands; they are case sensitive. • Update Declaration of Conformity. • Add information on O-ring maintenance. • Add caution regarding using spray can lubricants on MCBH connectors. • Add caution regarding using Parker Super O Lube, not Parker O Lube (which is petroleum based). • Remove <i>standard</i> and <i>optional</i> language related to SBE 35 features. • Update language on where to find software on website. • Switch to Sea-Bird Scientific cover.

Index

C

Cables · 11
 Calibration · 32, 34
 Calibration coefficient commands · 22
 CE certification · 3
 Cleaning · 34
 Clock · 9, 43
 Command summary · 45
 Commands
 calibration coefficients · 22
 data upload · 21
 date · 20
 descriptions · 19
 memory · 20
 sampling · 21
 setup · 20
 status · 19
 testing · 22
 Communication defaults · 17
 Connector · 10, 33
 Corrosion precautions · 33

D

Data formats · 23
 Data processing · 31
 Data upload command · 21
 Date commands · 20
 Declaration of Conformity · 3
 Deployment
 preparing for · 13
 Description · 8
 Dimensions · 10
 Disassembly · 44

E

Electrical symbols · 41
 Electronics disassembly/reassembly · 44
 End cap connector · 10

F

Fixed-point cells · 32
 Flooded instrument · 28
 Format
 data · 23
 Functional description · 42

G

Glossary · 40

I

Installation
 software · 13
 Interface box
 connectors · 9
 LEDs · 9
 Interface Box
 specifications · 9

L

Limited liability statement · 2

M

Maintenance · 33
 Manual revision history · 48
 Measurement cycle · 42
 Memory · 9, 43
 Memory command · 20

O

Operation
 CTD, Deck Unit, and Carousel · 25
 fixed-point cells · 32
 O-ring
 maintenance · 34

P

Parts
 replacement · 47

R

Recovery
 physical handling · 28
 uploading data · 29
 References · 46
 Replacement parts · 47
 Revision history · 48

S

Safety symbols · 41
 Sampling commands · 21
 SBE Data Processing · 8, 13, 31
 Seasave · 8, 13, 26, 27
 Seasoft · 8, 13
 Seaterm · 8, 13, 14, 15, 26, 27, 29
 main screen · 15
 toolbar buttons · 16
 SeatermV2 · 8, 13
 Setup commands · 20
 Software · 8
 Software installation · 13
 Specifications
 Interface Box · 9
 SBE 35 · 9
 SPRT · 32
 Status commands · 19
 System description · 8

T

Testing · 14
 Testing commands · 22

U

Unpacking SBE 35 · 7
 Uploading data · 29

V

Versions · 48

W

Wiring · 11