

D. Rudnick SN 2273  
20 APRIL 2000

# Seapoint Chlorophyll Fluorometer

## User Manual

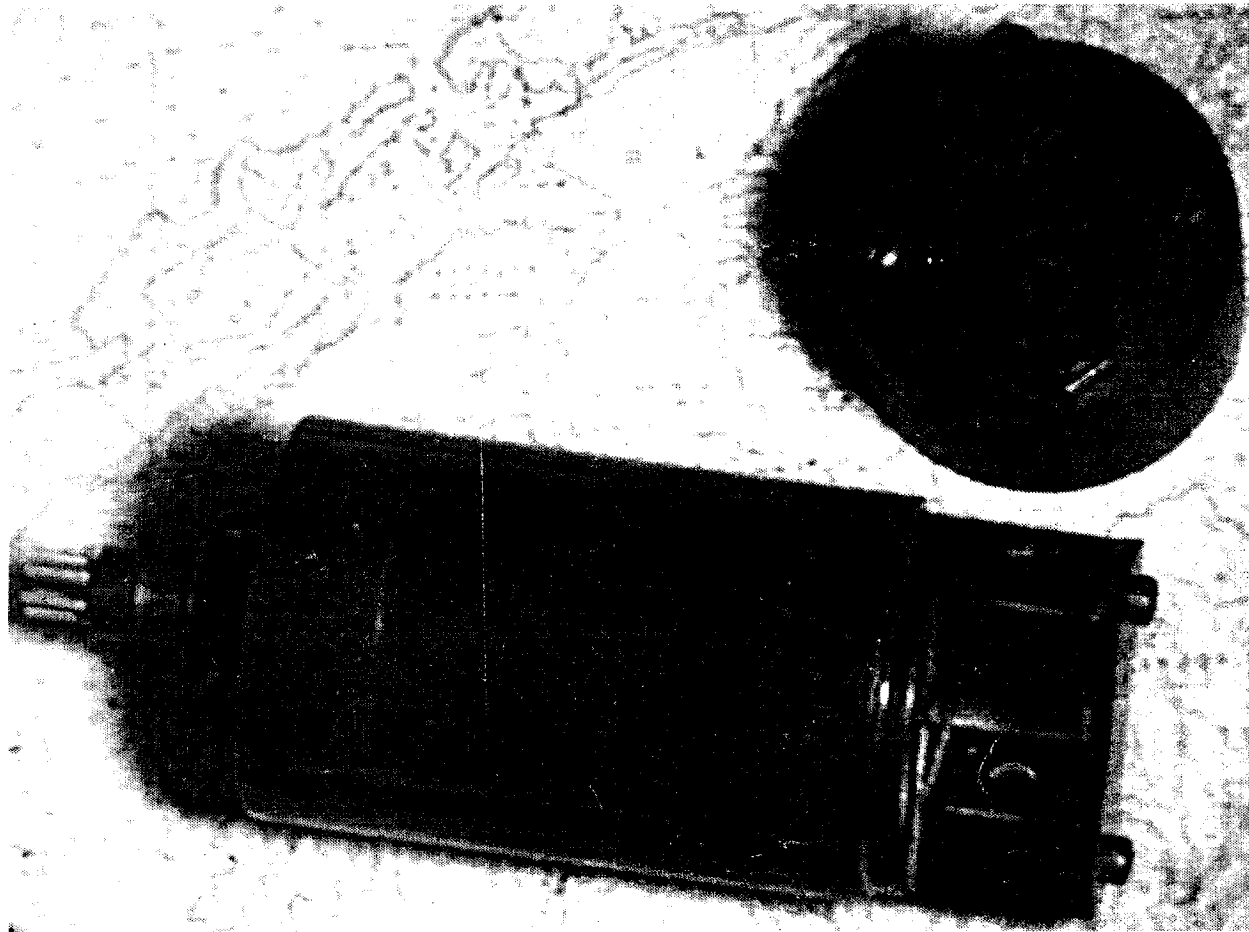

## *Seapoint Sensors, Inc.*

87 North Road  
Kingston, NH 03848-3056  
USA

Tel: 603-642-4921  
Fax: 603-642-4922  
[seapoint@seapoint.com](mailto:seapoint@seapoint.com)

# Dimensions

Open Configuration (no pump)

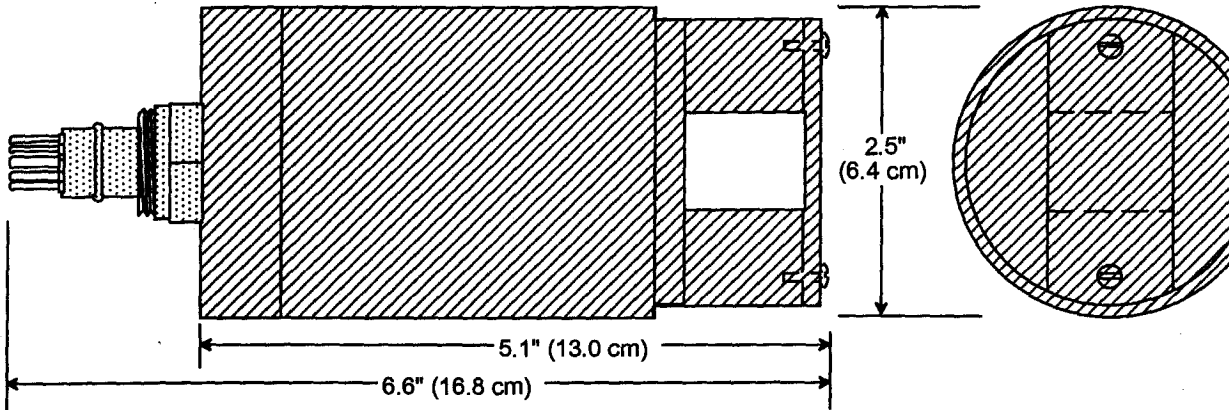

Pumped Configuration

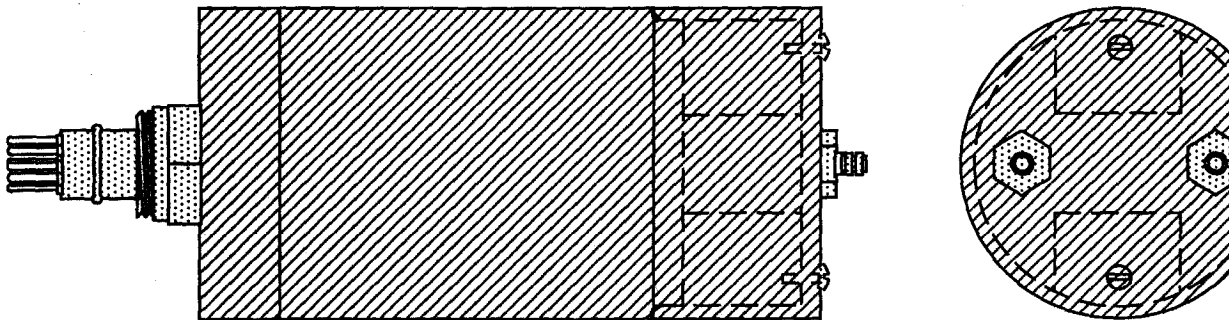

Figure 1. 1/2 Scale Drawing.

# Specifications

Power Requirements:	8-20 VDC, 15mA avg, 27mA pk	
Output:	0-5.0 VDC	
Output Time Constant:	0.1 sec	
Power-up Transient:	0.6 sec	
RMS Noise (typ.):	30x gain: 3 mV 10x gain: 1 mV 3x gain: <1 mV 1x gain: <1 mV	
Excitation Wavelength:	470 nm peak, 30 nm FBHM	
Emission Wavelength:	685 nm peak, 30 nm FBHM	
Sensing Volume:	340 mm <sup>3</sup>	
Sensitivity/Range <sup>†</sup> :	30x gain: 1.0 V/(μg/l)    5 μg/l 10x gain: 0.33 V/(μg/l)    15 μg/l 3x gain: 0.1 V/(μg/l)    50 μg/l 1x gain: 0.033V/(μg/l)    150μg/l	
Min. Detectable Level:	0.02 μg/l	
Temperature Coefficient:	<0.2 %/°C	
Operating Temperature:	0°C to 65°C	
Depth Capability:	6000 m	
Length:	16.8 cm	
Body Diameter:	6.4 cm	
Sensor Weight (dry):	850 g	

<sup>†</sup> Specified sensitivities and ranges are nominal values. Instrument should be calibrated for quantitative measurements.

# Introduction

The Seapoint Chlorophyll Fluorometer is a high-performance, low power instrument for *in situ* measurements of chlorophyll *a*. Its small size, very low power consumption, high sensitivity, wide dynamic range, 6000 meter depth capability, and open or pump-through sample volume options provide the power and flexibility to measure chlorophyll *a* in a wide variety of conditions. The instrument has good ambient light rejection and a low temperature coefficient.

The Seapoint Chlorophyll Fluorometer can be operated with or without a pump. The small sensing volume of approximately 340 mm<sup>3</sup> can be left open to the surrounding water, or, with the use of the supplied cap, can have water drawn through it using a pump.

Two control lines allow the user to externally set the sensitivity of the Seapoint Chlorophyll Fluorometer by choosing one of four gains. This provides an easy means to set the sensitivity to provide the range and resolution required for a particular application. Sensitivities of 0.033, 0.1, 0.33, and 1 V/(μg/l) are possible.

The Seapoint Chlorophyll Fluorometer is constructed of rugged, corrosion-free materials, surface mount electronics, and solid-state lamps and detector for excellent durability and high reliability.

The Seapoint Chlorophyll Fluorometer uses the same Impulse AG-206/306 connector as the Seapoint Turbidity Meter, and the two instruments are pin-compatible.

# Optical Design

Figure 2 shows the Seapoint Chlorophyll Fluorometer optics.

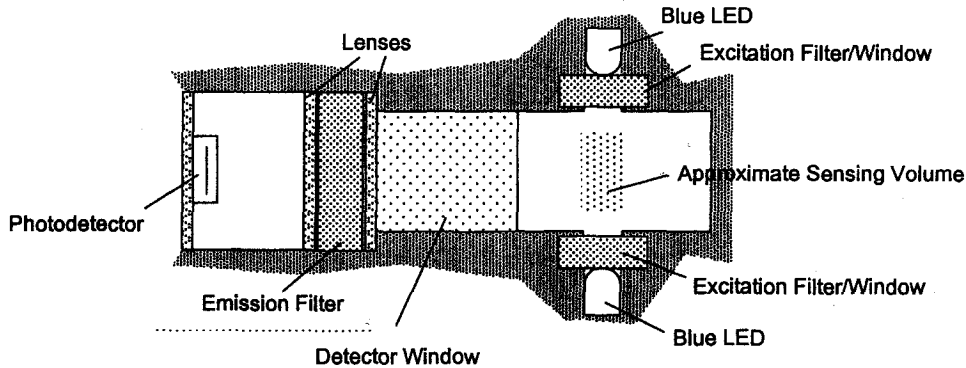

**Figure 2. Seapoint Chlorophyll Fluorometer Optics**

The blue LED lamps direct light through the blue excitation filter/windows illuminating the sensing volume. Chlorophyll *a* present in the sensing volume is excited with the blue light and fluoresces red light, a portion of which passes through the detector window. This fluorescent light is then collimated with a lens so that it passes through the emission filter nearly normal to the filter. A second lens then focuses the fluorescent light onto the detector.

The end plate of the instrument (or the cap in pumped operation) prevents ambient light from reaching the detector directly. The narrow bandwidth of the emission filter further reduces the amount of ambient light reaching the detector.

The sensing volume of the instrument is defined by the intersection of the lamp beams and the detector's cone of reception. This volume is nearly a cylinder of approximately 340 mm<sup>3</sup>.

## Electronic Design

The Seapoint Chlorophyll Fluorometer has an electronic design that achieves high sensitivity while consuming very little power. Surface mount components are used for high reliability and compact design. Low quiescent current components are used, allowing all but about 3 milliamps of the total current drawn by the instrument to drive the lamps. Overall power requirements are 8-20 VDC, 15 mA average, 27 mA peak.

The instrument is very stable with temperature and time. The LED lamps and the detector have low temperature coefficients at their respective operating wavelengths. The overall temperature coefficient of the instrument is less than 0.2%/°C. Degradation of the lamps with operating time will result in about 10% reduction in sensitivity after 5000 hours of operation. Stable output of the instrument occurs at approximately 0.6 seconds after power up.

The light source is modulated at 700 Hz and synchronous detection is used to extract the fluorescent signal from the unwanted portion of the signal resulting from ambient light and electronic noise. Achieving high sensitivity using low power was accomplished by paying careful attention to proper circuit board layout to prevent any stray coupling of signals synchronous with the modulation of the light source into the detection circuitry. The offset voltage is proportional to the selected gain.

# Operation

## Electrical Connections

The Seapoint Chlorophyll Fluorometer requires 8 to 20 VDC input and will draw an average of 15 mA current with a peak current draw of 27 mA. Output is 0 to 5.0 VDC with a 0.1 second time constant.

**Warning:** *Applying voltages to the output pin or powering the instrument with a voltage greater than 20 V will result in damage to the instrument.*

The Impulse AG-306 bulkhead (connector end of sensor) and the mating AG-206 connector (included with pigtail) should be cleaned and lubricated with 3M Silicone Spray, Dow Corning #111 Valve Lubricant or equivalent prior to connecting.

The pin numbering on the AG-306 is shown in Figure 3. Note that Pin 1 is larger than the other pins. The AG-206 connector has two raised bumps which align with Pin 1 to make connection with the AG-306 easy. The AG-206 pigtail is supplied with a locking sleeve which screws onto the AG-306 connector after the pigtail is plugged in.

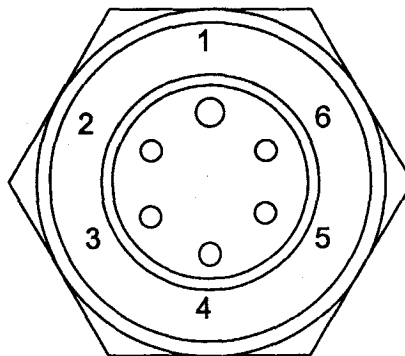

**Figure 3. AG-306 Pin numbering.**

Connections for the Impulse AG-206/306 are as follows:

50µg/l	}	→ Pin 1 ✓ white:	Power Ground
		Pin 2 ✓ black:	Signal Output
		Pin 3 ✓ blue:	Signal Ground
		Pin 4 ✓ orange:	Power In 8-20VDC @ 15ma
		→ Pin 5 ✓ green:	Gain Control A
		Pin 6 ✓ red:	Gain Control B

The two independent gain control lines A and B are used to select one of four possible gain settings (see Table 1). These wires can be hardwired for the desired gain or interfaced with a microprocessor, using 5 volt logic, to allow gain to be controlled through software. Hardwiring the gain does not require an external voltage source. To hardwire a line to +5V, simply leave it open, which allows an internal pull-up to hold it at +5 VDC. To set a line to 0V, tie it to the power ground.

<u>A</u>	<u>B</u>	<u>Gain</u>	<u>Sensitivity</u>	<u>Range</u>
+5 V	+5 V	30X	1 V/(µg/l)	5 µg/l
+5 V	0 V	10X	0.33 V/(µg/l)	15 µg/l
0 V	+5 V	3X	0.1 V/(µg/l)	50 µg/l
0 V	0 V	1X	0.033 V/(µg/l)	150 µg/l

**Table 1. Truth Table for Switching Gains**

The sensitivities and ranges given in Table 1 are nominal values for a typical instrument, and therefore the user should calibrate the instrument as described in the calibration section of this manual before making quantitative measurements.



## Considerations for Choosing Gain

Choosing an appropriate gain for a particular application will depend on a number of factors including expected chlorophyll concentrations, resolution of the data recorder's A/D converter, and whether smoothing will be applied to the data. The noise level of the instrument at 30X gain will be above the resolution of the A/D converters in most data loggers. The 150  $\mu\text{g/l}$  range at 1X gain is much greater than what is necessary to cover chlorophyll *a* concentrations in most natural waters. Therefore, for most applications 3X or 10X gain will be most appropriate.

## Filtering the Output for Improved Resolution

The Seapoint Chlorophyll Fluorometer has a low-pass filter with a 0.1 second time constant on its output (1.6 Hz cutoff frequency). In some applications, such as ocean profiling, this is useful in providing information which would be missed with a slower response. In other applications, such as with some moored applications, smoothing the data with a low-pass filter with a time constant greater than 0.1 second will be helpful in reducing the instrument noise thereby allowing lower chlorophyll *a* concentrations to be detected.

Analog filters can be constructed and placed between the instrument output and the A/D converter to smooth the output. Digital filtering can accomplish this as well, either before storing the data or during analysis of the data. Some data loggers have built-in averaging or smoothing functions which make this especially easy.

Figure 4(a) shows several time series of the instrument output at 30x gain. The top series shows the instrument output without any external filtering. The underlying series show the

effects of applying low-pass analog filtering to the instrument output. Frequency responses of the filters used are shown in Figure 4(b).

Figure 5(a) shows more time series of the instrument output at 30x gain. The top series shows the instrument output sampled at 0.11 second intervals. The underlying series were generated by digitally filtering the series with moving averages, as described by:

$$y_n = \frac{1}{N} \sum_{k=0}^N x_{i-k}$$

Figure 5(b) shows the frequency responses of the moving mean filters.

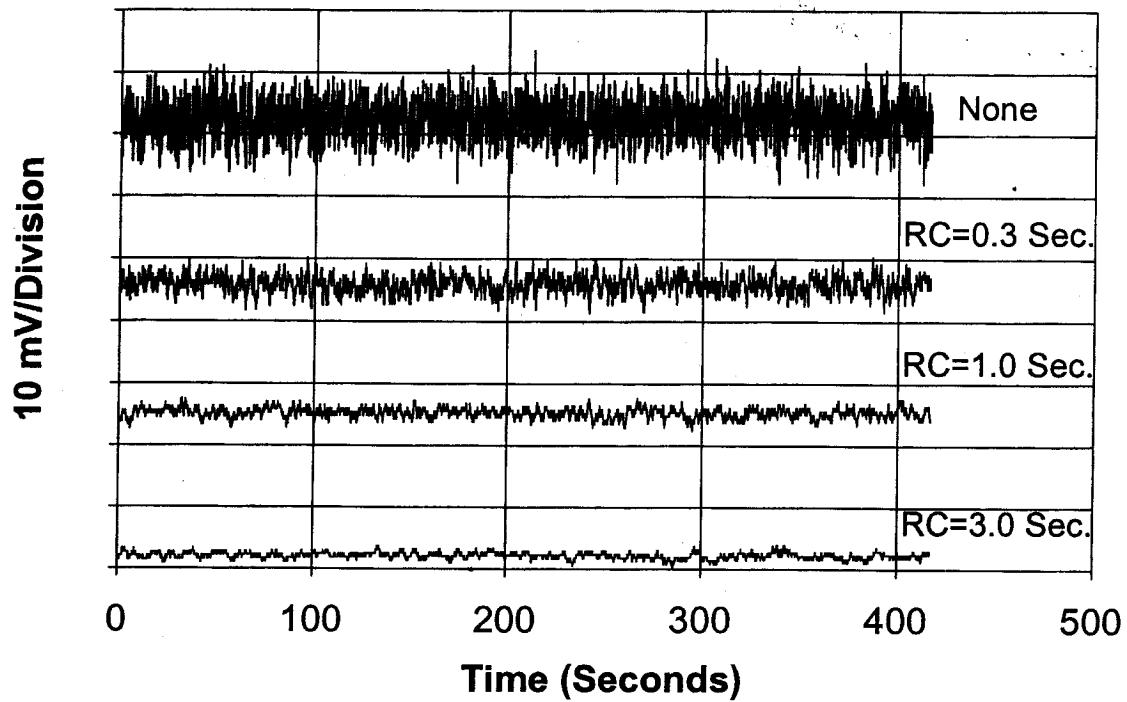

(a)

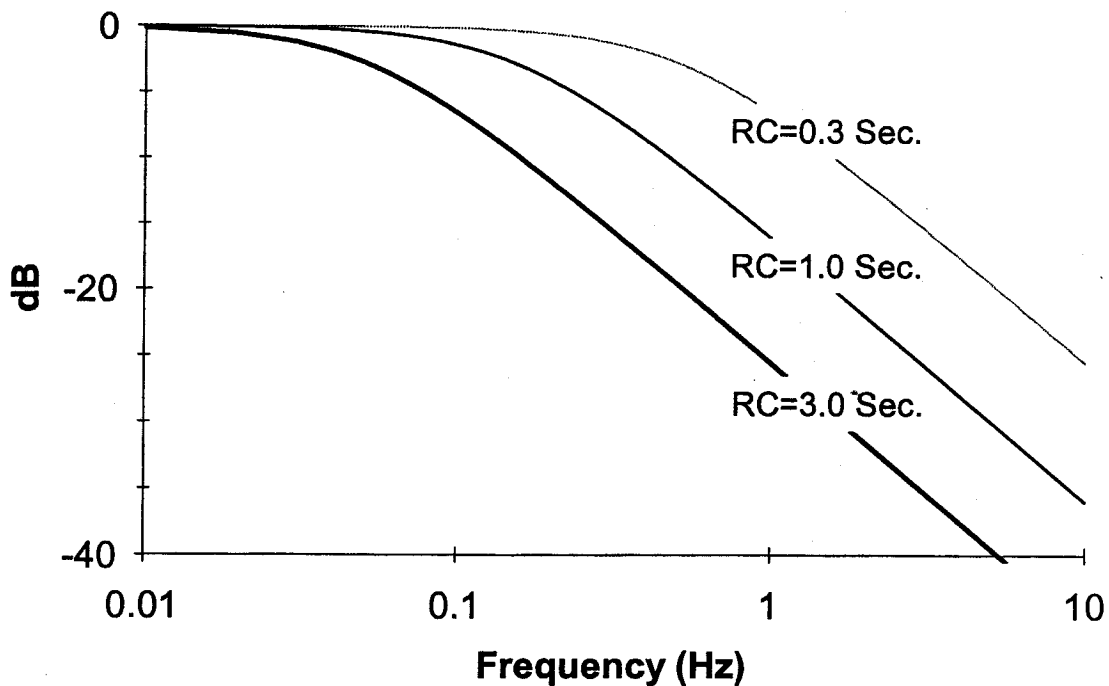

(b)

**Figure 4. (a) Time series of fluorometer output at 30x gain with and without low-pass analog filtering. (b) Frequency response of single pole RC filter.**

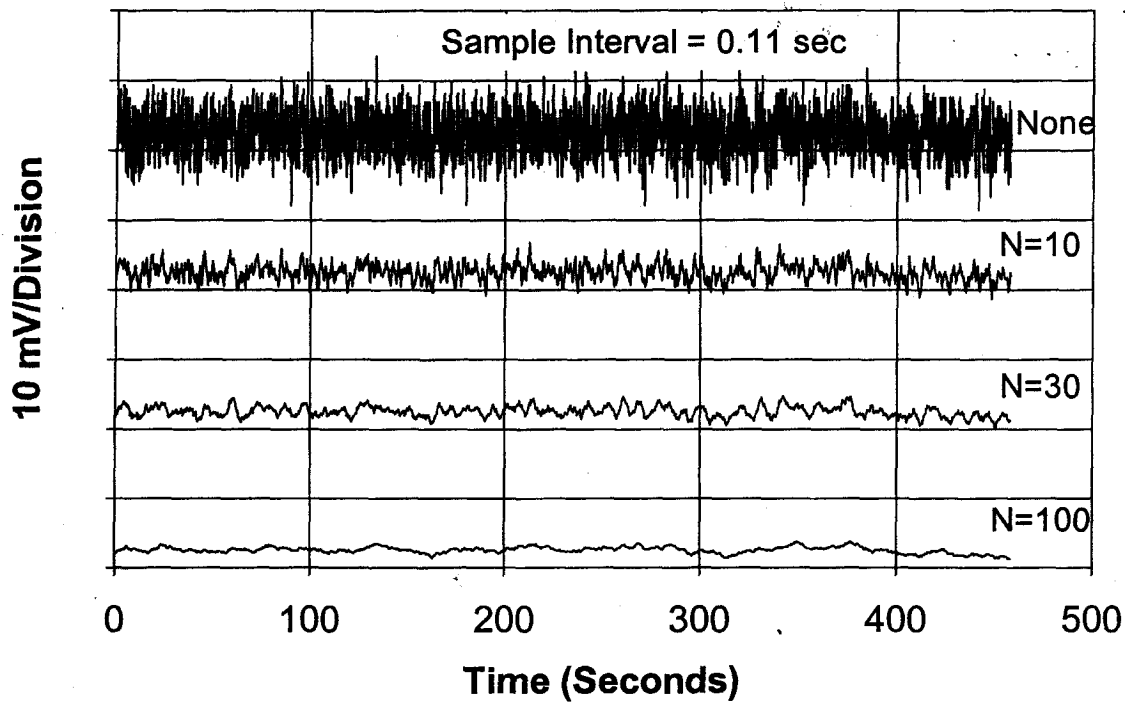

(a)

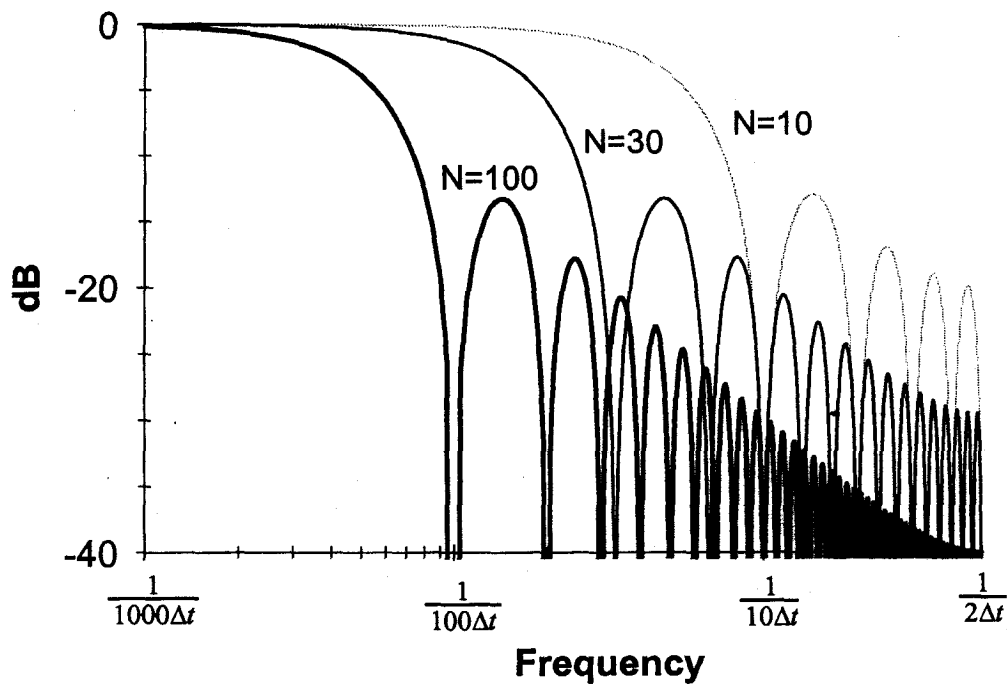

(b)

**Figure 5. (a) Time series of fluorometer output at 30x gain with and without digital filtering. (b) Frequency response of moving average digital filter.**

## **Ambient Light Concerns**

The combined optical filtering and synchronous detection give the Seapoint Chlorophyll Fluorometer good ambient light rejection, and ambient light will not be a concern when the instrument is capped and operated with a pump. When operating with an open sample volume, ambient light will not contribute an offset to the output voltage of the instrument, but strong fluctuating light may cause a noisy signal. This can happen under fluorescent or incandescent lighting or in surface waters in bright sunlight.

Laboratory lighting usually will not increase instrument noise as long as the detector window faces down, away from the lights. If the noisy output persists, shade the instrument or perform tests or calibrations in a vessel with opaque walls.

If field measurements are to be made near the water surface with an open sample volume, it is a good idea to experiment with the instrument beforehand, and try to determine if the noise caused by the ambient light will be significant. Again, ambient light rejection will be best with the detector window facing down. If the noise is indeed a concern, consider constructing a baffle to shade the instrument.

## **Measurement Configurations**

The Seapoint Chlorophyll Fluorometer may be configured for open or pumped measurements of chlorophyll *a* in water. Please note that the instrument is designed only for measurements in water. Never immerse the instrument in acetone solutions or pump acetone into the sensing volume, which will result in damage to the instrument body and windows.

The Seapoint Chlorophyll Fluorometer is supplied in the open sensing volume configuration. In this configuration, as the surrounding water flows past the instrument, it will also flow through the instrument's sensing volume

The Seapoint Chlorophyll Fluorometer also comes with a cap which can be placed over the end of the instrument so that water may be drawn through the instrument with a pump.

To install the cap, take off the end plate by removing the two screws that hold it in place. Slip the large O-ring over the lamp towers so that it rests on the reduced diameter of the instrument body. Then slip the cap over the lamp towers so that it presses the O-ring in place. Secure the cap with the two screws which have small O-rings to prevent leaking. The cap has nipples for 3/8" tubing. These nipples can be replaced to accommodate other tubing sizes.

When using the instrument in pumped operation in the laboratory, care should be taken to assure that air bubbles are eliminated before making measurements. In this regard, drawing water through the sample volume generally is more effective than pushing it through with the pump.

# Calibration

The Seapoint Chlorophyll Fluorometer is adjusted at the factory for the nominal range and sensitivity at a given gain setting as specified in this manual. However, for accurate quantitative measurements, user calibrations are required.

The Seapoint Chlorophyll Fluorometer is very stable, with very little change in sensitivity over time. Nonetheless, frequent calibration of the instrument is recommended. Some decrease in sensitivity can be expected after extended use due to decreased output of the lamps (about a 10% decrease in output after 5000 hours of operation) and scratched window surfaces.

Measurement of chlorophyll *a* and calibration of chlorophyll fluorometers is somewhat inexact, and users not familiar with calibration techniques and the considerations associated with this subject are urged to consult with experts in this field or refer to texts and papers for detailed discussion of these matters<sup>1-4</sup>.

1. Parsons, T.R., Maita, Y. & Lalli, C.M. 1984. A Manual of Chemical and Biological Methods for Sea Water Analysis, Pergamon, Oxford, 173 pp.
2. Smith, R.C., Baker, K.S., and Dustan, P. 1981. Fluorometric Techniques for the Measurement of Oceanic Chlorophyll in the Support of Remote Sensing, Scripps Institution of Oceanography Ref. 81-17, 14 pp.
3. Mills, D.K. & Tett, P.B. 1990. "Use of a recording Fluorometer for continuous measurement of phytoplankton concentration." *Environment and Pollution Measurement Sensors and Systems*, SPIE Proc., 1269, 106-115.
4. Yentsch, C.M. & Yentsch, C.S. 1984. "Emergence of optical Instrumentation for measuring biological properties." *Oceanography and Marine Biology*, an Annual Review, 22, 55-98.

## Care

The Seapoint Chlorophyll Fluorometer is a rugged instrument that should provide years of reliable performance with minimal care.

After using, rinse the instrument and clean the windows with water and mild detergent if necessary (avoid using organic solvents). If the detector window becomes scratched, it may be polished using a cloth buffing wheel with polishing compound, or returned to Seapoint Sensors, Inc. for refinishing or replacing.

The connectors should be lubricated before each use with 3M silicone Spray, Dow Corning #111 Valve Lubricant or equivalent.

The Seapoint Chlorophyll Fluorometer contains no user serviceable electronics and must be returned to the factory if it does not operate properly.

## Limited Warranty

Seapoint Sensors, Inc. warrants this Chlorophyll Fluorometer to be free of defects of materials and workmanship under normal use and service for a period of 1 year from the date of shipment. This warranty extends only to the original purchaser.

In the event the product fails to operate according to our published specifications during the warranty period, Seapoint Sensors, Inc. will repair or replace the instrument at our discretion. If it is determined that the failure was due to other than normal use or service, repairs will be billed and estimate will be submitted prior to repair work.

Shipping costs must be prepaid. Seapoint Sensors, Inc. accepts no responsibility for damage during return shipment.