

ADAM-4022T
Serial Base Dual Loops
PID Controller
User's Manual

Warning Message:

The ADAM-4022T is recommended to be used in general purposed air conditioning application. When using this product in applications that required particular safety or when using this product in important facility, pay attention to the safety of the overall system and equipment. For example, install fail-safe mechanism, carry out redundancy checks and periodic inspections, and adopt other appropriate safety measures as required.

ADAM-4022T dual loop PID Controller

Introduction

- Function** The ADAM-4022T dual loop PID controller is a Serial-based controller. It was designed as the product of Advantech's ADAM-4000 series with Serial based PID controller with an excellent accuracy $\pm 0.15\%$, the ADAM-4022T is an ideal controller for temperature and other process variable in heating and cooling application, test and environmental work.
- Easy to operate** ADAM-4022T utility software can help you to select input and range configuration, set the operating parameter (SP, Sv, Pv etc) for your process control needed. ADAM-4022T utility software also integrates the trend chart to help you to monitor and debug your control setting.
- Industrial Design** ADAM-4022T was designed to use in industrial environment. It can be installed in standard DIN rail inside the cabinet. And it can be powered by unregulated 10~30Vdc to meet the various power supplied source in field. It also withstands ambient temperature up to 60 ° C and resists the effects of vibration and mechanical shock.

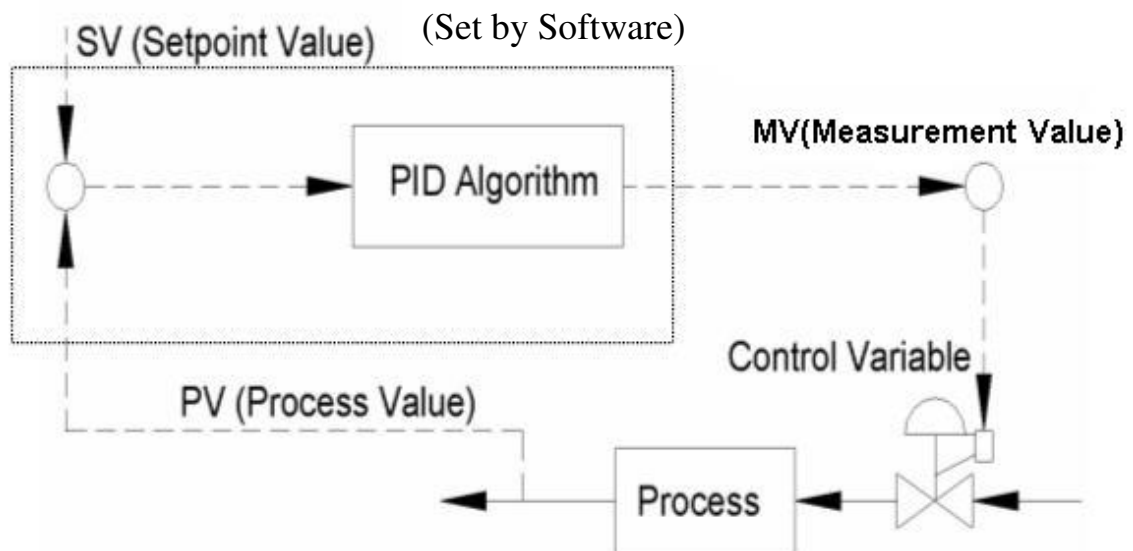

Specification of IO channels

Analog Input: 4 Channel Differential Input

- Effective resolution: 16-bit
- Individual wire burn-out detect
- Input type: 0~10V, 0~20mA, 4~20mA, Thermistor, RTD
- Isolation Voltage: 2000 V_{DC}
- Sampling rate: 10 samples/second
- Thermistor Type and Temperature Ranges
 - Thermistor 3K 0°C to 100°C
 - Thermistor 10K 0°C to 100°C
- RTD Type and Temperature Ranges
 - Pt 100 RTD
 - Pt -100°C to 100 °C
 - Pt 0 °C to 100 °C
 - Pt 0 °C to 200 °C
 - Pt 0 °C to 600 °C
 - IEC RTD 100 ohms ($\alpha = 0.00385$)
 - JIS RTD 100 ohms ($\alpha = 0.00392$)
 - Pt 1000 RTD
 - Pt -40°C to 160 °C

Accuracy: $\pm 0.15\%$ or better

Zero drift: $\pm 6 \mu\text{V}/^\circ\text{C}$

Span drift: $\pm 25 \text{ ppm}/^\circ\text{C}$

CMR @ 50/60 Hz: 92 dB

Analog Output: 2 Channels

Effective resolution: 12-bit

Output range: 0~10V, 0~20mA, 4~20mA

Accuracy: $\pm 0.05\%$ of FSR

Isolation Voltage: 2000 V_{DC}

Digital Input: 2 Channels

Logic level of Dry Contact: 0 close to GND
1 open

Digital Output: 2 Channels

Open Collector to 30V_{DC}, 100mA/max. load

Surge Protection (Power): 3000 V_{DC}

Built-in Watchdog Timer

Power requirements: Unregulated +10 ~ +30 V_{DC}

Power consumption: 4W @24 V_{DC}

Environment:

Operating temperature: -10° ~ 70° C

EMI: Meets CE and FCC Class A

Storage temperature: -25° ~ 85° C

Humidity: 5% ~ 95% non-condensing

Wiring & Installation

The ADAM-4022T is a Dual loop PID controller. There are one analog input, one analog output, one digital input and one digital out put for each loop usage. The analog input channels is 16-bit, universal signal accepted design. It provides programmable input ranges on all channels. It accepts various analog inputs +/-10V, 0~20mA and 4~20mA Thermistor, RTD. The analog output channel is 12 bit with 0~10V, 0~20mA and 4~20mA acceptable output type. Each analog channel is allowed to configure an individual range for several applications. The digital input can be configured as the emergency shutdown trigger input and the digital output is designed as the common alarm output. The PID loop function can be disabled by ADAM-4022T utility software tool, that is, ADAM-4022T can be a pure universal I/O module after disabling the PID loop function.

ADAM-4022T

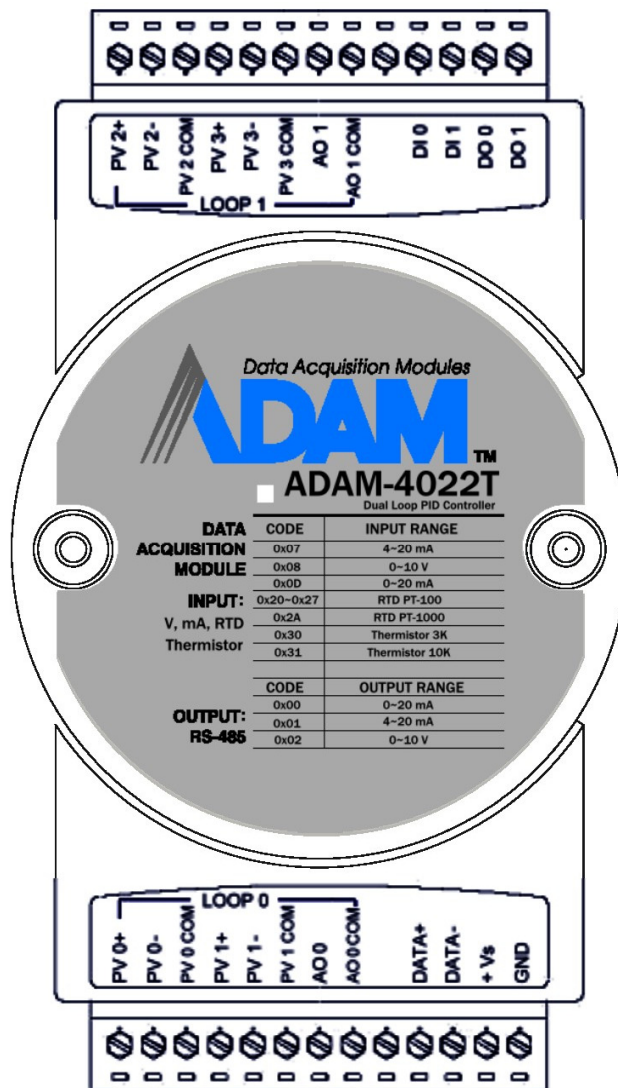

Fig. 1 ADAM-4022T Drawing

Application Wiring

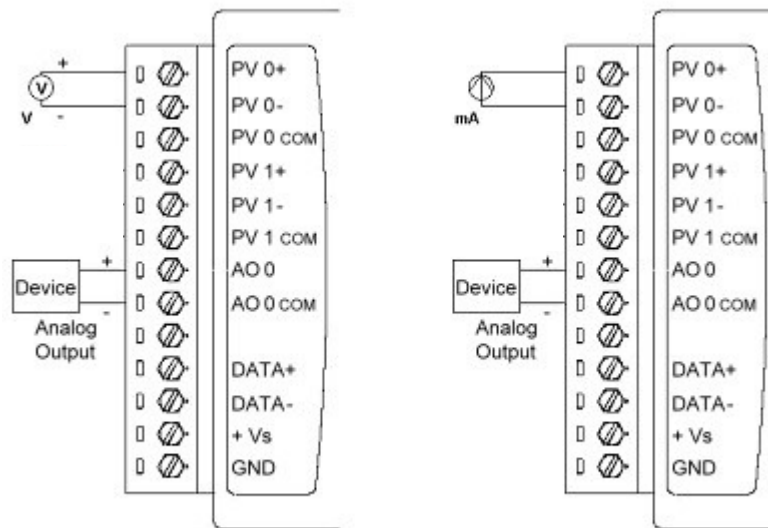

Fig. 2 Analog Input/Output Wiring Diagram

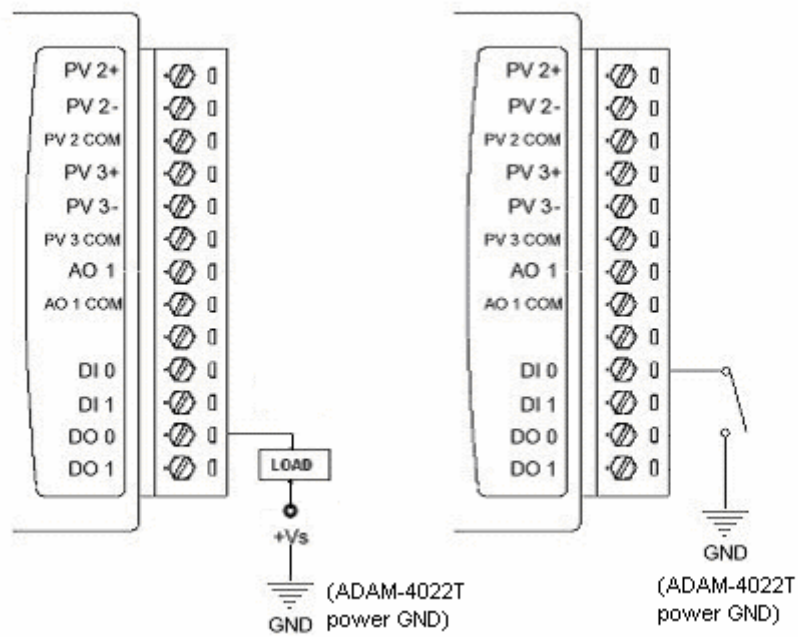
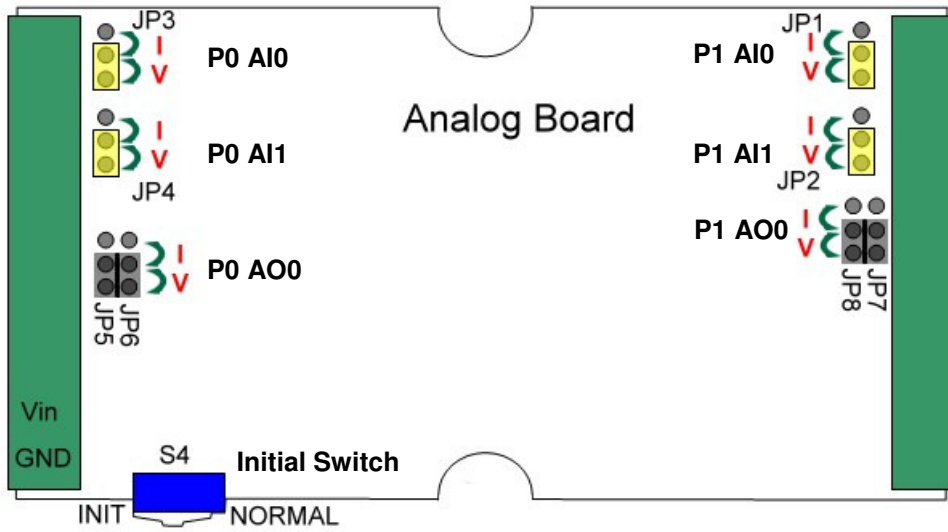

Fig. 3 Digital Input/Output Wiring Diagram

Jumper Setting



JP1	Loop 1 AI Channel 0
JP2	Loop 1 AI Channel 1
JP3	Loop 0 AI Channel 0
JP4	Loop 0 AI Channel 1
JP5,JP6	Loop 0 AO Channel 0
JP7,JP8	Loop 1 AO Channel 0

I: Current Signal

V: Voltage Signal

Input Default: V

Output default: I

Note: When using RTD or Thermistor, please set the jumper to voltage signal setting.

Initial Switch Setting

You can set the initial mode by switching the switch to INIT, after setting your ADAM-4022T, you can switch to NORMAL mode.

Operation Interface

Open the ADAM 4000 Utility Software, the software tool will auto-scan the ADAM 4000 module through the network. Clicking the “4022T” in the system tree of left dialog block,

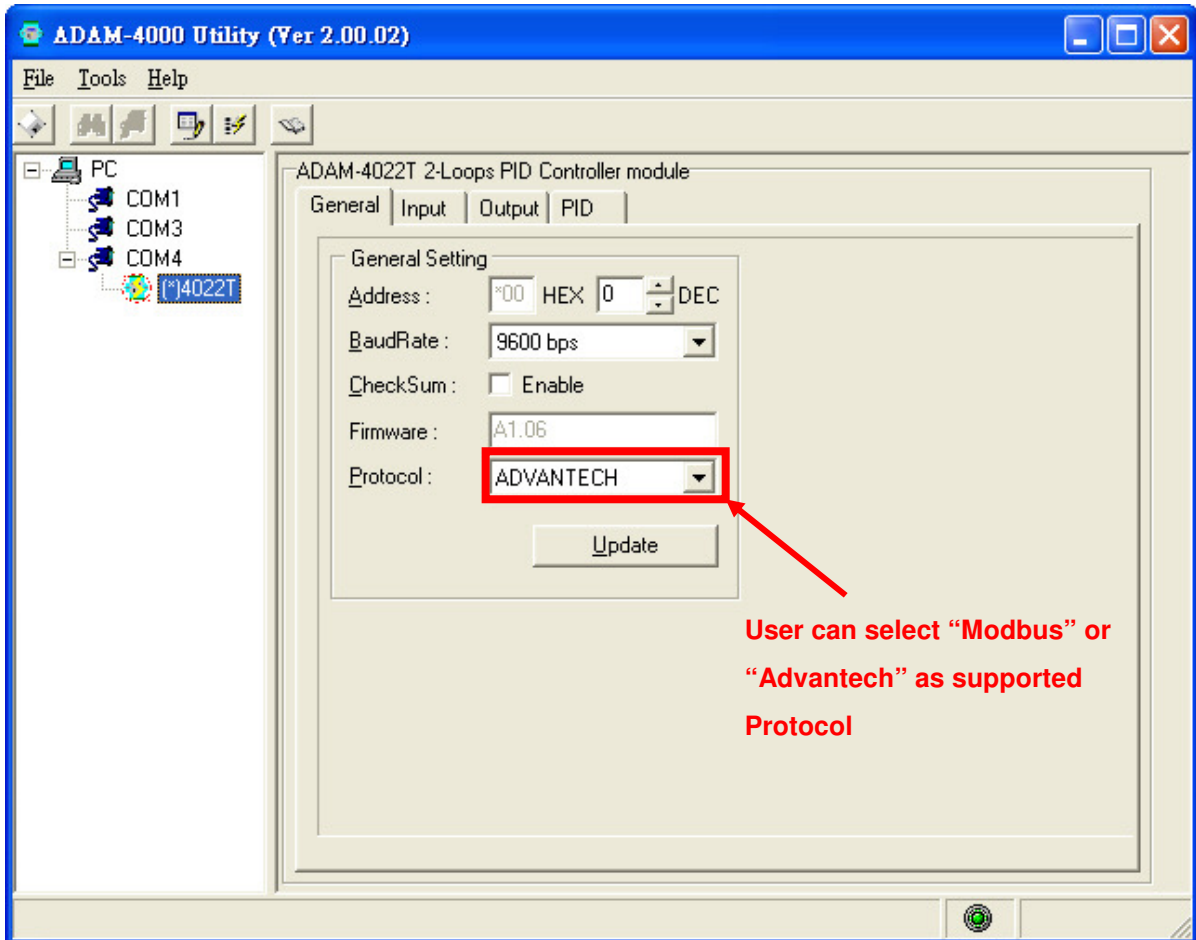

Clicking the “4022T” in the system tree of left dialog block to go to ADAM-4022T configuration page. In this page, user can configure the input channel, output channel and PID loop function.

And ADAM-4022T support two communication protocols – Modbus/RTU and Advantech. User can select the supported protocol in this page.

Input Channel Configuration Page:

In ADAM-4022T input channel configuration page, user can enable the input channel, select the input signal type and select the DI status. PV0 is the analog input as the control parameter for PID loop 0 and PV2 is for PID loop 1 when the PID loop function is enabled. ADAM-4022T also support MODBUS/RTU protocol, user can see the detail MODBUS address register number for each channel in this page. It can be a very important reference for communication work.

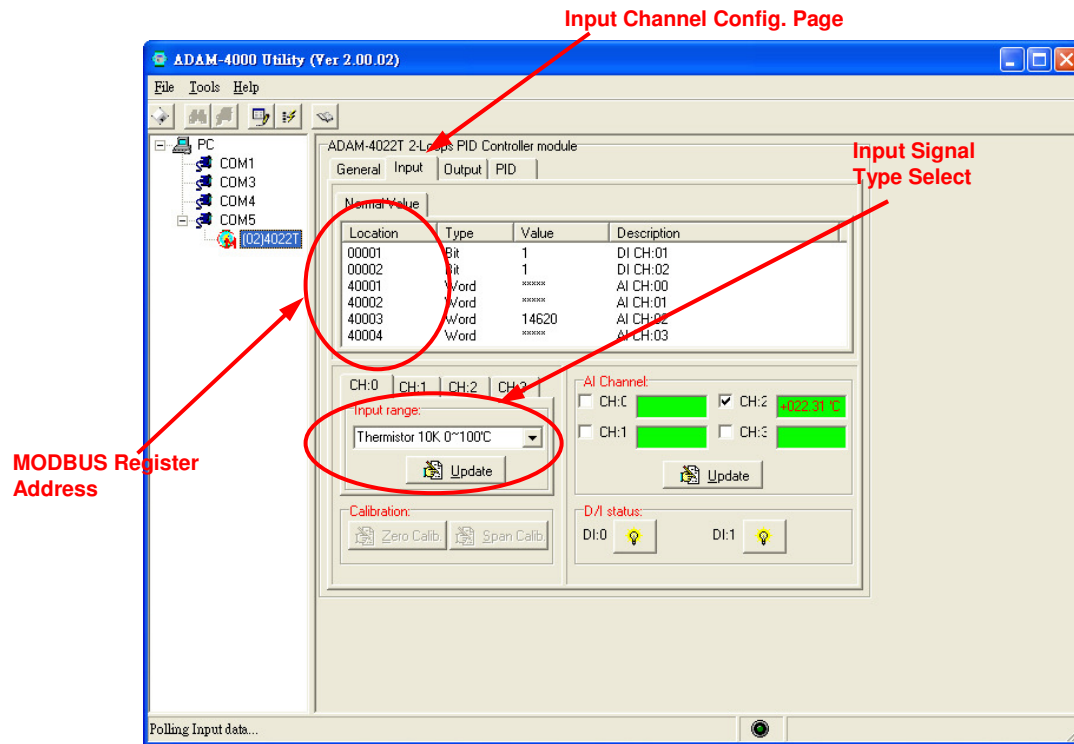

Calibration

Please configure ADAM-4022T into ***initial** mode before beginning calibration procedure. ADAM-4022T input channel configuration also support Zero and Span calibration function. Clicking the **“Zero Calib”** and **“Span Calib”** bottom to go to the calibration dialog block, user can set the initial zero value and span range then click the **“Execute”** bottom to precede the channel calibration work. Please refer the following pictures for operation guideline.

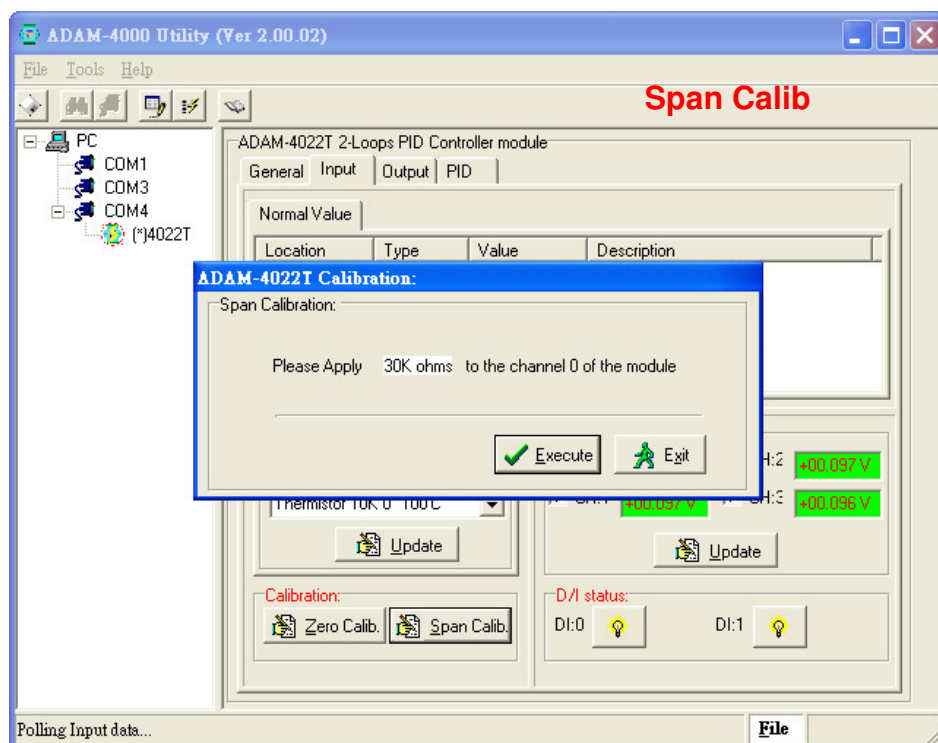
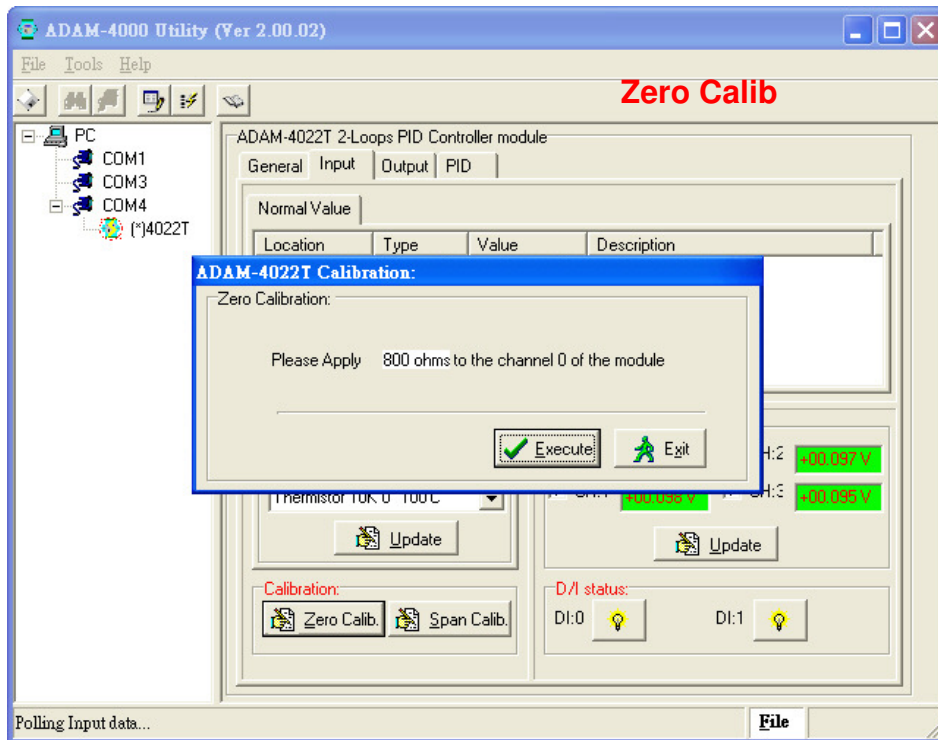

Output Channel Configuration Page:

For output channel configuration, there are two analog output channels in ADAM-4022T. The output channel 0 is used as the control output for PID loop 0 and channel 1 is for PID loop 1 when PID loop function is enabled. The configuration for output channel is quite similar as input configuration. User can easily to finish the configuration with the friendly operating interface of ADAM-4022T utility software.

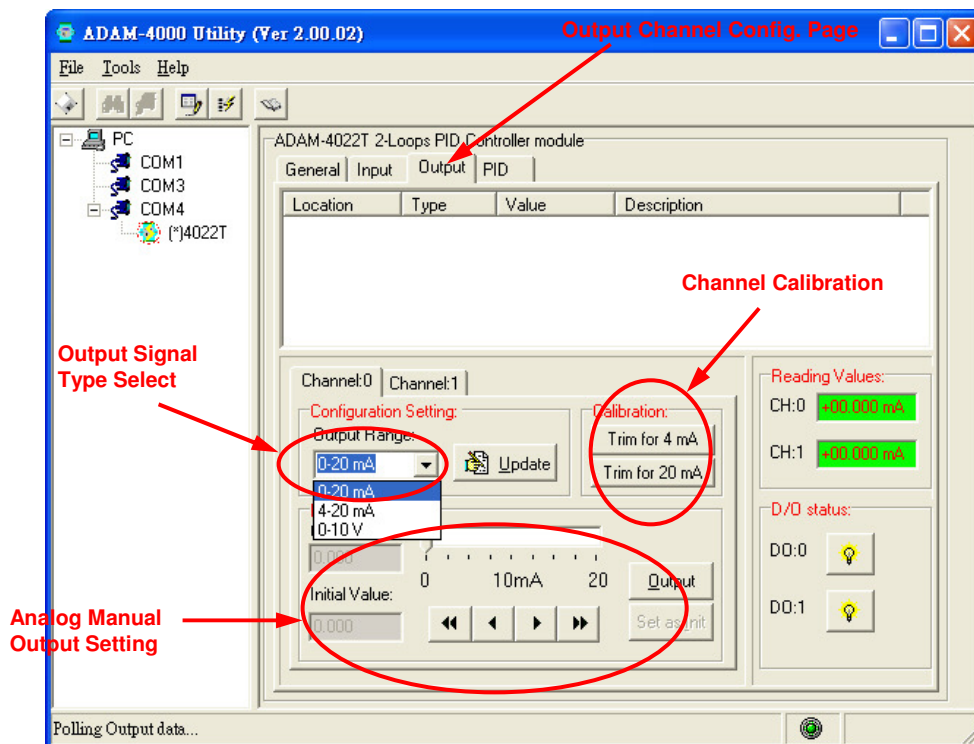

ADAM-4022T can be a pure universal I/O module when PID is set in free mode. User can use "Data Area" to setup the analog output to send a specific value for such kind application. This function can also be controlled with MODBUS/TCP protocol through Ethernet network for HMI/SCADA application.

For calibrating the analog output channel, user can use external certificated signal measured device as calibrator then use the "Trim for 4mA" and "Trim for 20mA" calibrating function to fine tuning the channel output signal for calibration requirement.

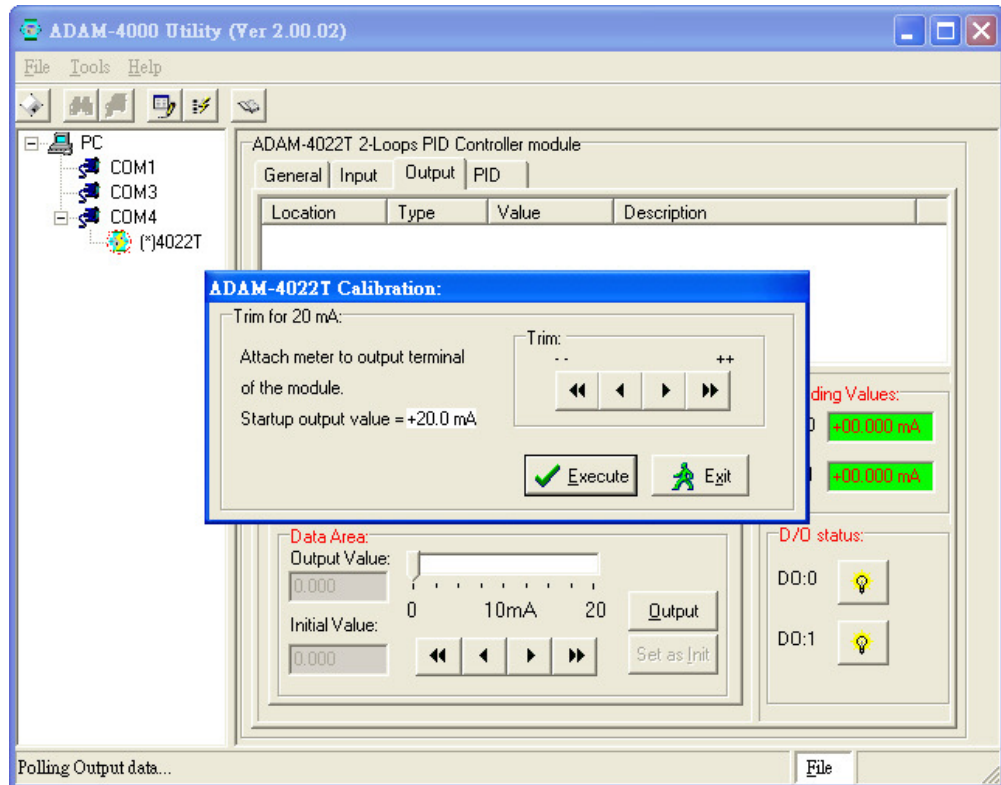
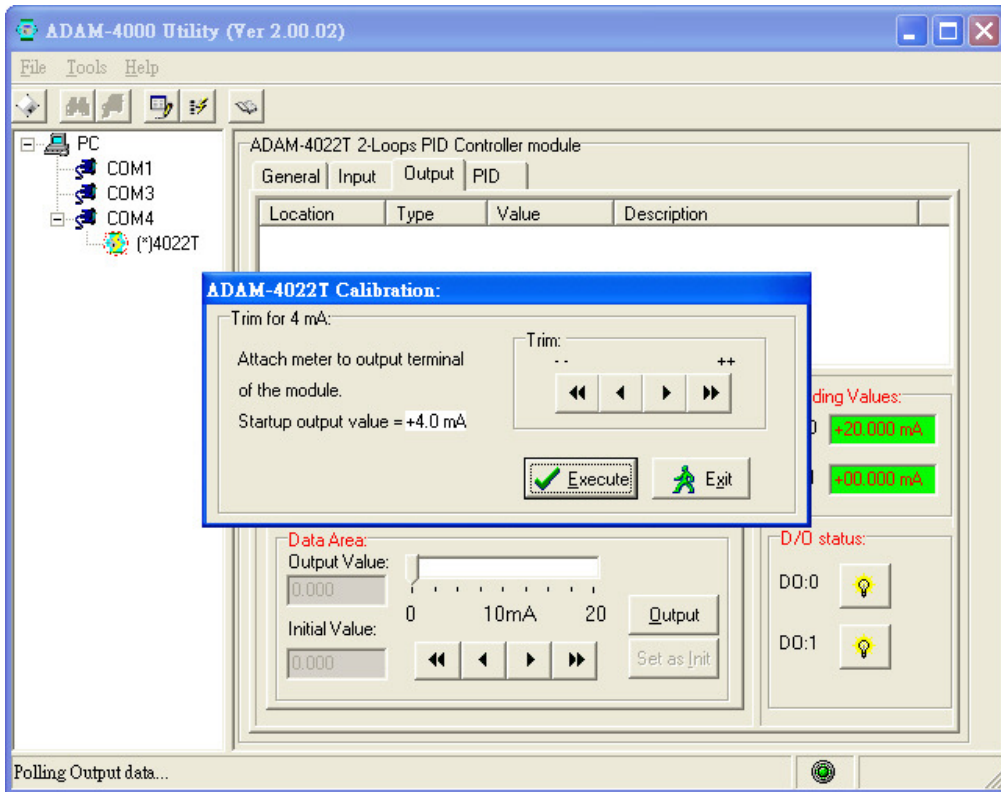

PID Loop Configuration

ADAM-4022T is designed as a stand alone PID controller. We offer a very convenient software tool for user to configure the PID controlled parameter. In this configuration page, there is a real time trend chart to show the values changing of SV, PV and MV. It is very helpful for user to monitor and diagnose the PID control situation.

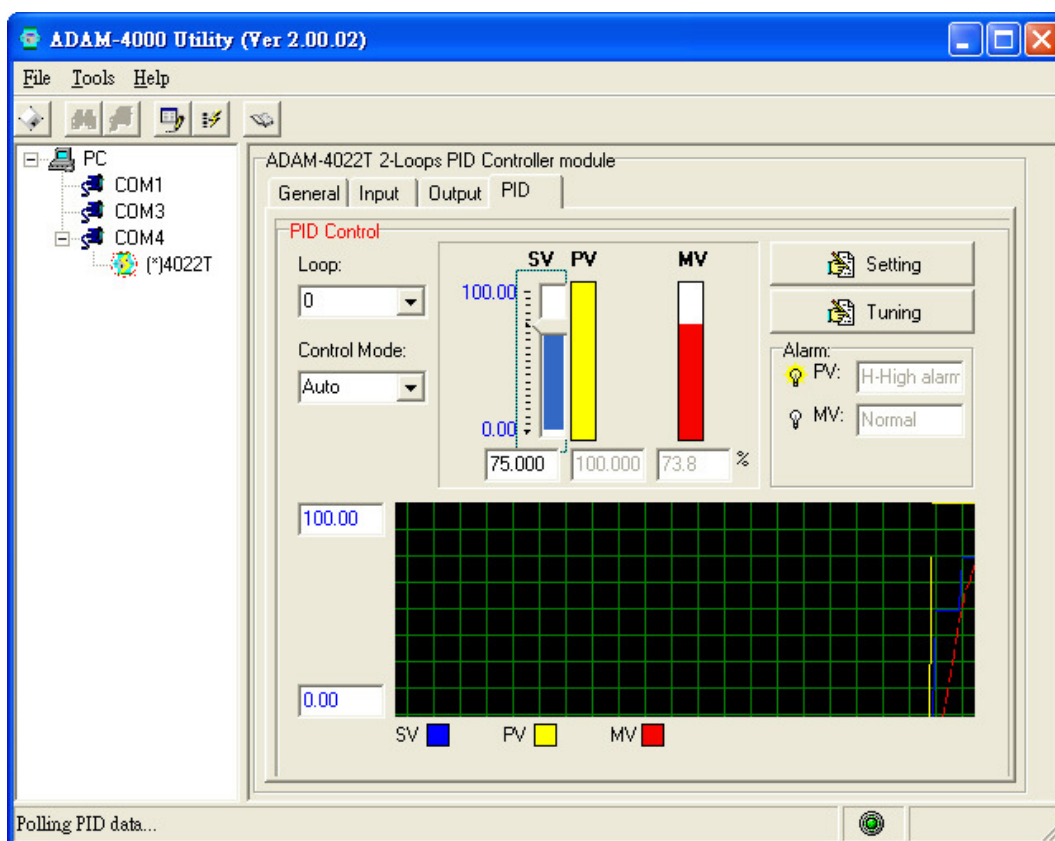

For the functionality of the bottom in PID configuration page, please refer the explanation of the following table.

Bottom	Function
<p>Loop:</p> <p>0</p>	PID loop number
<p>Control Mode:</p> <p>Auto</p>	Control Mode Selection : Free : Stop PID Control Auto : PID Loop Automatically Manual : Manual Control

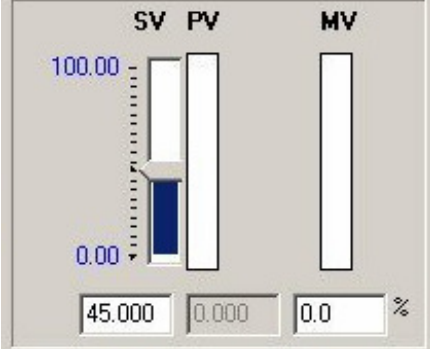
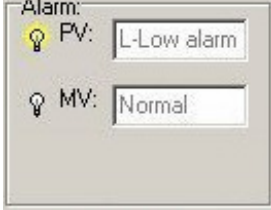
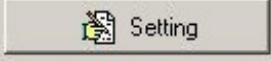
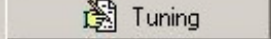
	<p>Parameter Setting and Monitoring SV : Setpoint Value PV : Process Value MV : Controlled Output Value</p>
	<p>PV, MV Alarm Status</p>
	<p>PID Setting Button (go to PID setting page)</p>
	<p>PID Tuning Button (go to PID tuning page)</p>

After finishing the setup work in configuration page, please click the setting bottom to go to the detail parameter setting screen.

PV/SV Setting:

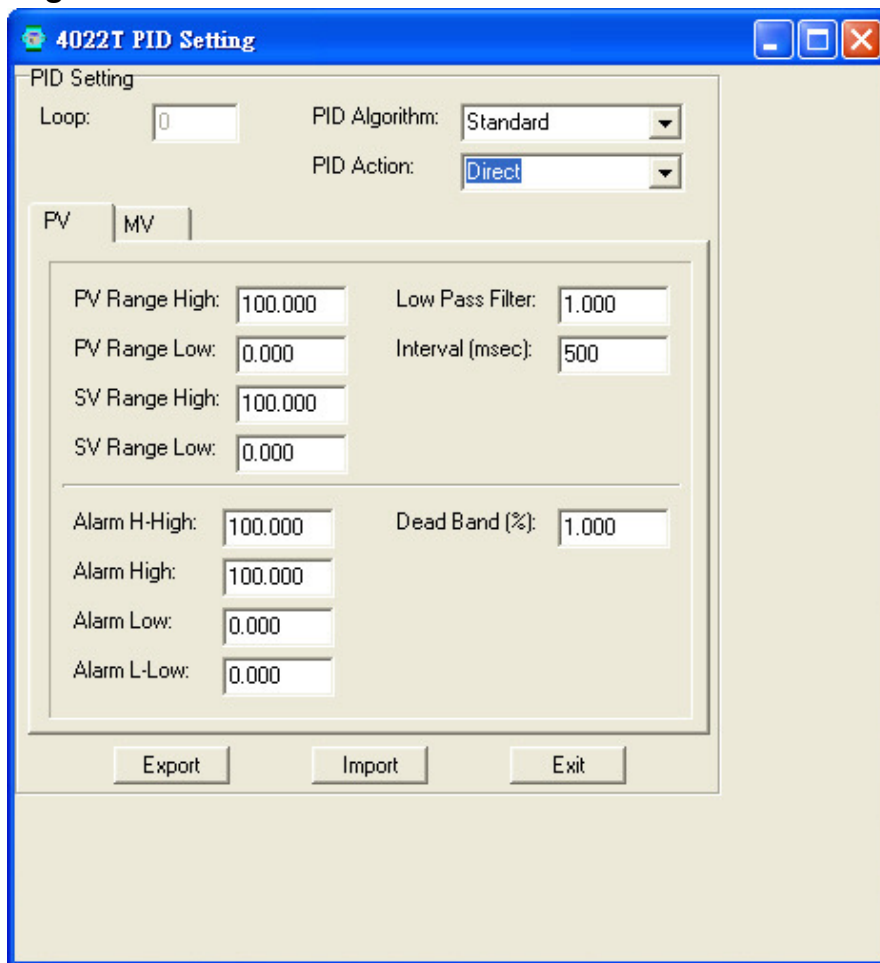

Button	Function
	PID Algorithm: Standard: Standard PID calculation. DIFF First: Differentiation as first priority.
SV Range High	SV high limit value
SV Range Low	SV low limit value
PV Range High	PV high limit value
PV Range Low	PV low limit value
Low Pass Filter	Low Pass Filter set value Low Pass Filter Calculation : $MV \text{ Feedback} = \text{Reading MV} \times \text{Filter Value} + \text{Previous MV} \times (1 - \text{Filter Value})$
Interval (msec)	PID loop sensing time interval
Alarm H-High	SV & PV High High alarm setpoint
Alarm High	SV & PV High alarm setpoint
Alarm Low	SV & PV Low Low alarm setpoint
Alarm L-Low	SV & PV Low alarm setpoint

MV Setting

Button	Function
	<p>PID Action: Control Action Mode Setting</p> <p>Direct: Direct (Heating) Action, The "MV" decreases when the "PV" increases.</p> <p>Reverse: Reverse (Cooling) Action, The "MV" increases when the "PV" increases.</p>
Range High	MV/FB high limit value
Range Low	MV/FB low limit value
Filter (0.0~1.0)	Filter set value
MV Init. Value	Setting MV initial value
MV Output High	MV output high limit
MV Output Low	MV output low limit
MV E-Stop Value	Setting MV frozen value while PID being emerged shutdown

For PID parameter tuning, please refer the PID tuning page.

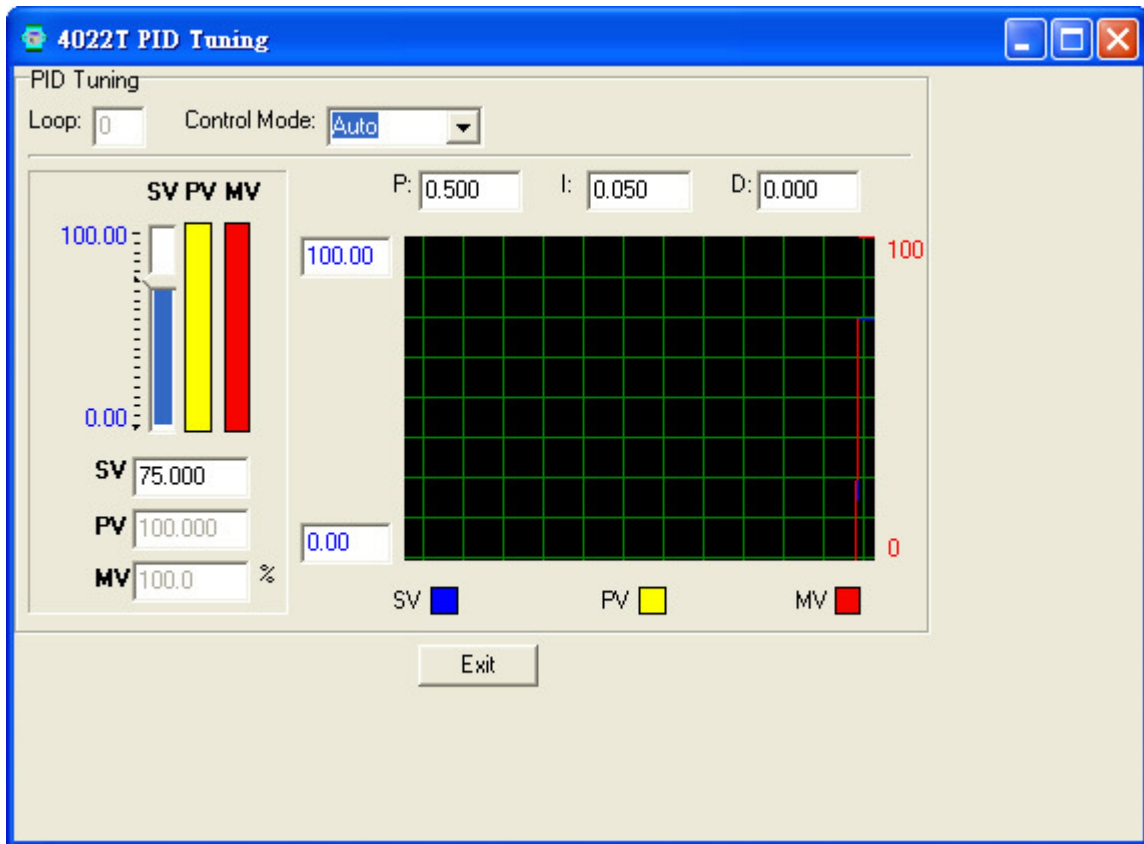

In this page, the P, I, D parameters can be adjusted to achieve the optimal control result. The real time trend chart provides a powerful tool for user to supervise the parameters adjustment result.

Appendix A

ASC II Command Set

Command	Description	Remarks
% AANNTTCCFF	Sets the address, input mode, baud rate, checksum status AA : Current Module Address NN: new address, TT: always 00 CC: baud rate Index 03: 1200 bps 04: 2400 bps 05: 4800 bps 06: 9600 bps 07: 19200 bps 08: 38400 bps 09: 57600 bps 0A: 115200 bps FF: bit6=1 checksum enable bit6=0 checksum disable)	!NN: OK ?AA: error
\$AAB	Read channel diagnostic	!AAmmmm: OK (mmmm: 0000 normal 1111 over highest value 2222 over lowest value 3333 invalid calibration) ?AA: error
\$AAF	Return the firmware version code from the specified module.	!AAv.vv(version): OK ?AA: error
\$AAM	Return the module name from the specified module	!AA4022T: OK ?AA: error
\$AA0	Calibrate the analog input module to correct the gain error	!AA: OK ?AA: error
\$AA1	Calibrate the analog input module to correct the offset error	!AA: OK ?AA: error
\$AA2	Returns the configuration parameters.	!AA00CCFF: OK ?AA: error
\$AA2Ci	Read the MAX calibration value for analog output (i: channel 0~1)	!AACihhh: OK ?AA: error
\$AA2Cihhh	Calibrate the analog output to correct the MAX value (i: channel 0~1 hhh: 12bits raw data)	!AA: OK ?AA: error
\$AA3Ci	Read the MIN calibration value for analog output (i: channel 0~1)	!AACihhh: OK ?AA: error
\$ AA3Cihhh	Calibrate the analog output to correct the MIN value (i: channel 0~1 hhh: 12bits raw data)	!AA: OK ?AA: error
\$AA5vv	Enable/Disable multiplexing (vv: 00~0F)	!Aa: OK ?Aa: error
\$AA6	Asks a specified input module to return the status of all AI channels	!AAvv: OK ?AA: error
\$AA7	Asks a specified module to return the status of all DI/DO channels	!AAooii: OK ?AA: error
\$AA7CiRrr	Set the channel input range code (i: channel 0~3 rr: range code, please refer to Appendix B)	!AA: OK ?AA: error

\$AA8Ci	Read the channel input range code (i: channel 0~3)	!AACiRrr: OK ?AA: error
\$AA9Ci	Read the channel output range code (i: channel 0~1)	!AACiRrr: OK ?AA: error
\$AA9CiRrr	Set the channel output range code. After setting, the output will be set to minimum value. (i: channel 0~1 rr: range code)	!AA: OK ?AA: error
#AA	Return the input values from all channels of the specified analog input module	>+xx.xxx+xx.xxx+xx.xxx+xx.xxx: OK (format: V, mA is xx.xxx; RTD, Thermistor is xxx.xx) ?AA: error
#AAi	Return the input value from the specified channel in the analog input module (i: channel 0~3)	>+xx.xxx: OK ?AA: error
#AAccdd	Set a single or all digital output channels. (cc: 00 all channel, dd: 00~03 10 channel 0, dd:00~01 11 channel 1, dd:00~01)	>: OK ?AA: error
#AACidd.ddd	Analog output to the specified channel (i: channel 0~1 dd.ddd: engineering units)	>: OK ?AA: error
#AAO	Read all AO channel value	>+xx.xxx+xx.xxx: OK ?AA: error
#AAOi	Read AO value from an output channel (i: channel 0~1)	>: OK ?AA: error
#AAPRsscc	Read PID value (ss: starting index, Loop 0 : 00h~4Fh, Loop 1 : 80h~CFh cc: total to read data - MAX. 64 data can be read in once) * Please refer the below "PID Value Index Table.	>aaaaaaaaabbbbbbbb...: OK each value use 8 HEX to indicate a long value ?AA: error
#AAPWssvvvvvvv	Set PID value (ss: index, 00h~FFh vvvvvvv: the long value) * Please refer the below "PID Value Index Table.	>: OK ?AA: error

#AAPRsscc

Name	Read PID value
Description	The command requests and read the PID value like as Process value at address AA.
Syntax	#AAPRsscc (cr) # is a delimiter character. AA (range 00-FF) represents the 2-character hexadecimal address that you want to interrogate. PR is the Read PID value command. ss: starting index, Loop 0 : 00h~4Fh Loop 1 : 80h~CFh cc: total to read the number of index data - MAX. 64 data can be read in once (cr) is the terminating character, carriage return (0Dh).
Response	>aaaaaaaaabbbbbbbb..... if the command is valid. ?AA(cr)if an invalid operation was entered. There is no response if the module detects a syntax error or communication error or if the specified address does not exist. > delimiter character indicates a valid command was received. ? delimiter character indicates the command was invalid. aaaaaaaaabbbbbbbb is the two HEX long value due to each value use 8 HEX to indicate a long value
Example	command: #01PR0402(cr) response: >00001FFF000002FF The command reads the data of Process value_1 bare data and Process value_2 bare at address 01h due to 0402 means starting index is Process value_1 and total data is 2. User can refer PID Value Index Table for ASCII Mode The Process value_1 bare data and Process value_2 bare at address 01h respond with 00001FFF000002FF(HEX). It means Process value_1 bare data is 8.191(Decimal) and Process value_2 bare data is 0.767(Decimal) due to their Decimal place is 3

#AAPWssvvvvvvvv

Name	Set PID value
Description	The command sets the PID value like as setting of Manual/Free/PID mode at address AA.
Syntax	#AAPWssvvvvvvvv (cr) # is a delimiter character. AA (range 00-FF) represents the 2-character hexadecimal address that you want to interrogate. PW is the Set PID value command. ss: index, Loop 0 : 00h~4Fh Loop 1 : 80h~CFh vvvvvvv: the long value, please refer the below "PID Value Index Table (cr) is the terminating character, carriage return (0Dh).
Response	> if the command is valid. ?AA(cr)if an invalid operation was entered. There is no response if the module detects a syntax error or communication error or if the specified address does not exist. >delimiter character indicates a valid command was received. ?delimiter character indicates the command was invalid.
Example	command: #01PW0000000002(cr) response: > The command sets Loop 1 as "manual mode"due to 00 is the index no and 00000002 is to select the Manual mode. User can refer PID Value Index Table for ASCII Mode

PID Value Index Table for ASCII Mode

Index no. (HEX) Loop0	Index no. (HEX) Loop1	Code	Read/Write	Decimal Place	Descriptions
0	80	Manual/PID/Free Mode	Read / Write	0	Enable/Disable PID loop function 0:Free mode -- no PID control, ADAM-4022T will be a pure I/O module 1:PID mode – enable PID loop function 2:Manual mode – manual control analog output
1	81	PID Mode	Read / Write	0	PID Mode Selection 0:Standard PID Calculation Mode 1:Differential First Mode
2	82	PV Mode	Read / Write	0	0:Select PV Source 1 as “PV” 1:Select PV Source 2 as “PV”
4	84	Process value_1 bare data	Read Only	3	Loop 0 PV_0 value °
5	85	Process value_2 bare data	Read Only	3	Loop 0 PV_1 value
6	86	Manipulator value bare data	Read Only	3	MV value
8	88	DI On/Off	Read Only	0	DI for Emergency Shutdown
9	89	DO On/Off	Read Only	0	Alarm DO On
a	8a	Set point Value(for PV-1)	Read / Write	3	SV (Setpoint Value) for loop 0
b	8b	Set point Value(for PV-2)	Read / Write	3	SV (Setpoint Value) for loop 1
c	8c	PV_1 RH (Range high)	Read / Write	3	PV Source 1 Engineering Value Range high (PV_1 RH must > PV_1 RL)
d	8d	PV_1 RL (Range low)	Read / Write	3	PV Source 1 Engineering Value Range low (PV_1 RL must < PV_1 RH)
e	8e	PV_2 RH (Range high)	Read / Write	3	PV Source 2 Engineering Value Range high (PV_1 RH must > PV_1 RL)
f	8f	PV_2 RL (Range low)	Read / Write	3	PV Source 2 Engineering Value Range low (PV_1 RL must < PV_1 RH)
10	90	MV RH (Range high)	Read / Write	3	MV Engineering Value Range high MV RH must > MV RL
11	91	MV & FB RH (Range low)	Read / Write	3	MV Engineering Value Range high MV RL must < MV RL
12	92	PV-1 engineering data	Read Only	3	PV Source 1 engineering data
13	93	PV-2 engineering data	Read Only	3	PV Source 2 engineering data

14	94	MV engineering data	Read / Write	3	MV engineering data MV engineering data can not only be automatically created by PID loop, but it also can be manual setup when PID loop set in "manual" mode. It will be translated as MV bare data AO output ° MV RL<MV engineering data<MV RH
16	96	PID PV value	Read Only	3	PID PV value
17	97	PID SV value	Read Only	3	PID SV value
18	98	PV_1 Filter value	Read / Write	3	1st order filter value for PV source 1 $0 < (PV_1 \text{ Filter value}/1000) < 1.0$
19	99	PV_2 Filter value	Read / Write	3	2nd order filter value for PV source 1 $0 < (PV_2 \text{ Filter value}/1000) < 1.0$
1b	9b	PV_1 Signal Range	Read Only	0	0: -10 ~ 10V 、 1: 0 - 20mA 、 2: 4 - 20mA
1c	9c	PV_2 Signal Range	Read Only	0	0: -10 ~ 10V 、 1: 0 - 20mA 、 2: 4 - 20mA
1e	9e	MV Signal Range	Read Only	0	0: 0 ~ 10V 、 1: 0 - 20mA 、 2: 4 - 20mA
1f	9f	PID KP (PV-1)	Read / Write	3	PID Proportional factor for PV Source 1 PID KP=(Input value/1000)
20	a0	PID KI (PV-1)	Read / Write	3	PID Integrated factor for PV Source 1 PID KI=(Input value/1000)
21	a1	PID KD (PV-1)	Read / Write	3	PID Differential factor for PV Source 1 PID KD=(Input value/1000)
22	a2	PID KP (PV-2)	Read / Write	3	PID Proportional factor for PV Source 2 PID KP=(Input value/1000)
23	a3	PID KI (PV-2)	Read / Write	3	PID Integrated factor for PV Source 2 PID KI=(Input value/1000)
24	a4	PID KD (PV-2)	Read / Write	3	PID Differential factor for PV Source 2 PID KD=(Input value/1000)
25	a5	PID KP (PID)	Read Only	3	PID Proportional factor for PID calculation
26	a6	PID KI (PID)	Read Only	3	PID Integrated factor for PID calculation
27	a7	PID KD (PID)	Read Only	3	PID Differential factor for PID calculation
28	a8	Control loop period setting (msec) for PV-1	Read / Write	0	<=0 : Loop empty >0 : Loop controlling
29	a9	Control loop period setting (msec)for PV-2	Read / Write	0	<=0 : Loop empty >0 : Loop controlling
2a	aa	Control loop period setting (msec)for PID	Read Only	0	<=0 : Loop empty >0 : Loop controlling
2b	ab	Count down value of control loop period	Read Only	0	counting value<=0 then calculating PID loop
2c	ac	Record last Loop mode	Read Only	0	Record the last Loop manual or auto mode for Loop Initial set °
2d	ad	NSEC	Read Only	0	Calculating the newest Loop interval as nsec
2e	ae	OLD NSEC	Read Only	0	Calculating the previous Loop interval as old nsec

2f	af	Power recovery action setting	Read / Write	0	0: maintaining the previous MV output keep PID open 1: setting the previous MV output as initial value and keeping PID Close 2: PID open, using MV initial value as MV output
30	b0	MV Initial Value	Read / Write	3	MV initial value for power recovery action
31	b1	Last DI State	Read Only	0	Previous Scan DI State (reference for control program)
32	b2	Last DO State	Read Only	0	Previous Scan DO State (reference for control program)
33	b3	PV-1 Alarm HH limit	Read / Write	3	PV-1 Alarm High High Limit Value (<PV-1 RH)
34	b4	PV-1 Alarm H limit	Read / Write	3	PV-1 Alarm High Limit Value (<PV-1 RH & PV-1 Alarm HH)
35	b5	PV-1 Alarm LL limit	Read / Write	3	PV-1 Alarm Low Low Limit Value (>PV-1 RL)
36	b6	PV-1 Alarm L limit	Read / Write	3	PV-1 Alarm Low Limit Value (>PV-1 RL & PV-1 Alarm LL)
37	b7	PV-1 Alarm Dead Band %	Read / Write	3	PV-1 Dead band % 0<(Input Value/1000)%<10 %
38	b8	PV-1 Alarm Status	Read Only	0	PV-1 Alarm Status 0 : Normal 、 1:HH 、 2 : H 、 3:L 、 4:LL ◦
39	b9	PV-2 Alarm HH limit	Read / Write	3	PV-2 Alarm High High Limit Value (<PV-2 RH)
3a	ba	PV-2 Alarm H limit	Read / Write	3	PV-2 Alarm High Limit Value (<PV-2 RH & PV-2 Alarm HH)
3b	bb	PV-2 Alarm LL limit	Read / Write	3	PV-2 Alarm Low Low Limit Value (>PV-2 RL)
3c	bc	PV-2 Alarm L limit	Read / Write	3	PV-2 Alarm Low Limit Value (>PV-2 RL & PV-2 Alarm LL)
3d	bd	PV-2 Alarm Dead Band %	Read / Write	3	PV-2 Dead band % 0<(Input Value/1000)%<10 %
3e	be	PV-2 Alarm Status	Read Only	0	PV-2 Alarm Status 0 : Normal 、 1:HH 、 2 : H 、 3:L 、 4:LL ◦
45	c5	MV Output High Limit	Read / Write	3	MV Output High Limit (<MV RH)
46	c6	MV Output Low Limit	Read / Write	3	MV Output Low Limit (>MV RL)
47	c7	MV Output Alarm Status	Read Only	0	MV Output Alarm Status 0 : Normal 、 1:H 、 2 : L
48	c8	MV Emergency Value	Read / Write	3	MV output value while emergency shutdown DI being active
49	c9	PV-1 open wire flag	Read Only	0	0 : Normal 1 : Open wire
4a	ca	PV-2 open wire flag	Read Only	0	0 : Normal 1 : Open wire
4b	cb	PID Direct/Reverse	Read / Write	0	0 : Direct Mode 1 : Reverse Mode
4c	cc	SV-1 High Limit	Read/ Write	3	SV-1 High Limit value
4d	cd	SV-1 Low Limit	Read / Write	3	SV-1 Low Limit value
4e	ce	SV-2 High Limit	Read / Write	3	SV-2 High Limit value
4f	cf	SV-2 Low Limit	Read / Write	3	SV-2 Low Limit value

Appendix B

Channel Specification

Analog input channel

Channel index in command	Channel index in hardware
0	LOOP0 Ain0
1	LOOP0 Ain1
2	LOOP1 Ain0
3	LOOP1 Ain1

Input range code mapping and input calibration value

Range code	Range value	Span calibration	Zero calibration
0x07	4~20 mA	20.0 mA	0.0 mA
0x08	0~10 V	10 V	0 V
0x0D	0~20 mA	20.0 mA	0.0 mA
0x20	PT-100 (-100~100°C) a=0.00385	140 ohms	60 ohms
0x21	PT-100 (0~100°C) a=0.00385	140 ohms	60 ohms
0x22	PT-100 (0~200°C) a=0.00385	180 ohms	60 ohms
0x23	PT-100 (0~600°C) a=0.00385	400 ohms	60 ohms
0x24	PT-100 (-100~100°C) a=0.00392	140 ohms	60 ohms
0x25	PT-100 (0~100°C) a=0.00392	140 ohms	60 ohms
0x26	PT-100 (0~200°C) a=0.00392	180 ohms	60 ohms
0x27	PT-100 (0~600°C) a=0.00392	400 ohms	60 ohms
0x2A	PT-1000 (-40~160°C)	1600 ohms	850 ohms
0x30	Thermistor 3K (0~100°C)	10 K ohms	200 ohms
0x31	Thermistor 10K (0~100°C)	30 K ohms	800 ohms

Output range code mapping

Range code	Range value
0x00	0 ~ 20 mA
0x01	4 ~ 20 mA
0x02	0 ~ 10 V

Appendix C

PID Parameters Table for Modbus address :

Modbus Register Loop 0	Modbus Register Loop 1	Code	Read/ Write	Decimal Place	Descriptions
41000	41256	Open/Close Mode	Read / Write	0	Enable/Disable PID loop function 0:Free mode -- no PID control, ADAM-4022T will be a pure I/O module 1:PID mode – enable PID loop function 2:Manual mode – manual control analog output
41002	41258	PID Mode	Read / Write	0	PID Mode Selection 0:Standard PID Calculation Mode 1:Differential First Mode
41008	41264	Process value bare data	Read Only	3	PV value °
41012	41268	Manipulator value bare data	Read Only	3	MV value
41016	41272	DI On/Off	Read Only	0	DI for Emergency Shutdown
41018	41274	DO On/Off	Read Only	0	Alarm DO On
41020	41276	Set point Value	Read / Write	3	SV (Set point Value)
41024	41280	PV RH (Range high)	Read / Write	3	PV Source Engineering Value Range high (PV RH must > PV RL)
41026	41282	PV RL (Range low)	Read / Write	3	PV Source Engineering Value Range low (PV RL must < PV RH)
41032	41288	MV RH (Range high)	Read / Write	3	MV Engineering Value Range high MV RH must > MV RL
41034	41290	MV & FB RH (Range low)	Read / Write	3	MV Engineering Value Range high MV RL must < MV RL
41036	41292	PV engineering data	Read Only	3	PV Source engineering data
41040	41296	MV engineering data	Read / Write	3	MV engineering data can not only be automatically created by PID loop, but it also can be manual setup when PID loop set in “manual” mode. It will be translated as MV bare data AO output ° MV RL<MV engineering data<MV RH

Modbus Register Loop 0	Modbus Register Loop 1	Code	Read/ Write	Decimal Place	Descriptions
41044	41300	PID PV value	Read Only	3	PID PV value
41046	41302	PID SV value	Read Only	3	PID SV value
41048	41304	PV Filter value	Read / Write	3	1st order filter value for PV source $0 < (PV \text{ Filter value} / 1000) < 1.0$
41054	41310	PV Range	Read Only	0	0: 0 ~ 10V 1: 0 - 20mA 2: 4 - 20mA 3: PT-100 (385) -100~100°C 4: PT-100 (385) 0~100°C 5: PT-100 (385) 0~200°C 6: PT-100 (385) 0~600°C 7: PT-100 (392) -100~100°C 8: PT-100 (392) 0~100°C 9: PT-100 (392) 0~200°C 10: PT-100 (392) 0~600°C 11: PT-1000 -40~160°C 12: Thermistor 3K 0~100°C 13: Thermistor 10K 0~100°C
41060	41316	MV Range	Read Only	0	0: 0 ~ 10V 、 1: 0 - 20mA 、 2: 4 - 20mA
41062	41318	PID KP	Read / Write	3	PID Proportional factor for PV Source $PID \text{ KP} = (\text{Input value} / 1000)$
41064	41320	PID KI	Read / Write	3	PID Integrated factor for PV Source $PID \text{ KI} = (\text{Input value} / 1000)$
41066	41322	PID KD	Read / Write	3	PID Differential factor for PV Source $PID \text{ KD} = (\text{Input value} / 1000)$
41074	41330	PID KP (PID)	Read Only	3	PID Proportional factor for PID calculation
41076	41332	PID KI (PID)	Read Only	3	PID Integrated factor for PID calculation
41078	41334	PID KD (PID)	Read Only	3	PID Differential factor for PID calculation

Modbus Register Loop 0	Modbus Register Loop 1	Code	Read/ Write	Decimal Place	Descriptions
41080	41336	Control loop period setting (msec) for PV	Read / Write	0	<=0 : Loop empty >0 : Loop controlling
41084	41340	Control loop period setting (msec)for PID	Read Only	0	<=0 : Loop empty >0 : Loop controlling
41086	41342	Count down value of control loop period	Read Only	0	counting value<=0 then calculating PID loop
41088	41344	Record last Loop mode	Read Only	0	Record the last Loop manual or auto mode for Loop Initial set °
41090	41346	NSEC	Read Only	0	Calculating the newest Loop interval as nsec
41092	41348	OLD NSEC	Read Only	0	Calculating the previous Loop interval as old nsec
41094	41350	Power recovery action setting	Read / Write	0	0: maintaining the previous MV output keep PID open 1: setting the previous MV output as initial value and keeping PID Close 2: PID open, using MV initial value as MV output
41096	41352	MV Initial Value	Read / Write	3	MV initial value for power recovery action
41098	41354	Last DI State	Read Only	0	Previous Scan DI State (reference for control program)
41100	41356	Last DO State	Read Only	0	Previous Scan DO State (reference for control program)
41102	41358	PV Alarm HH limit	Read / Write	3	PV Alarm High High Limit Value (<PV RH)
41104	41360	PV Alarm H limit	Read / Write	3	PV Alarm High Limit Value (<PV RH & PV Alarm HH)
41106	41362	PV Alarm LL limit	Read / Write	3	PV Alarm Low Low Limit Value (>PV RL)

Modbus Register Loop 0	Modbus Register Loop 1	Code	Read/ Write	Decimal Place	Descriptions
41108	41364	PV Alarm L limit	Read / Write	3	PV Alarm Low Limit Value (>PV RL & PV Alarm LL)
41110	41366	PV Alarm Dead Band %	Read / Write	3	PV Dead band % 0<(Input Value/1000)%<10 %
41112	41368	PV Alarm Status	Read Only	0	PV Alarm Status 0 : Normal 、 1:HH 、 2 : H 、 3:L 、 4:LL °
41138	41394	MV Output High Limit	Read / Write	3	MV Output High Limit (<MV RH)
41140	41396	MV Output Low Limit	Read / Write	3	MV Output Low Limit (>MV RL)
41142	41398	MV Output Alarm Status	Read Only	0	MV Output Alarm Status 0 : Normal 、 1:H 、 2 : L
41144	41400	MV Emergency Value	Read / Write	3	MV output value while emergency shutdown DI being active
41146	41402	PV open wire flag	Read Only	0	0 : Normal 1 : Open wire
41150	41406	PID Direct/Reverse	Read / Write	0	0 : Direct Mode 1 : Reverse Mode
41152	41408	SV High Limit	Read/ Write	3	SV High Limit value
41154	41410	SV Low Limit	Read / Write	3	SV Low Limit value

MODBUS functions address mapping

(1) Coils Address Mapping Table

Index(Address)	Remarks
1(0)	DI 0 status
2(1)	DI 1 status
3~16(2)~(15)	Reserved (for those reserved area, there will be no effect if you set it)
17(16)	DO 0 status
18(17)	DO 1 status
19~128(18)~(127)	Reserved

(2) Registers Address Mapping Table

Index(Address)	Remarks
1(0)	P0Ain0 value
2(1)	P0Ain1 value
3(2)	P1Ain0 value
4(3)	P1Ain1 value
5~10(4)~(9)	Reserved
11(10)	AO 0 value
12(11)	AO 1 value
13~20(12)~(19)	Reserved
21(20)	P0Ain0 status (0: normal; 1: over high; 2: over low; 3: invalid calibration)
22(21)	P0Ain1 status
23(22)	P1Ain0 status
24(23)	P1Ain1 status
25~200(24)~(199)	Reserved
201(200)	P0Ain0 range code
202(201)	P0Ain1 range code
203(202)	P1Ain0 range code
204(203)	P1Ain1 range code
205(204)	AO 0 range code
206(205)	AO 1 range code
207~210(206)~(209)	Reserved
211~212(210)~(211)	Module name
213~214(212)~(213)	Version
221(220)	AI channel enable
1000~1511 (999)~(1510)	<p>PID data area (total 512 registers)</p> <ul style="list-style-type: none"> ● Each PID data formed by two registers, for example: PID data[0] = reg[1000]*65535+reg[1001] ● PID loop-0 occupies from PID data[0] to PID [127]. ● PID loop-1 occupies from PID data[128] to PID [255]. ● For function 0x03, 0x04, you can read 100 registers at most one time ● For function 0x10, you must set even number of registers at a time. The starting address must be an even number as well. You can only set at most 100 registers at a time.
---	Not support