



SEA-BIRD
SCIENTIFIC

User Manual

Release Date: 02/20/2015

SBE Sea-Bird
Electronics

SBE 37-SI MicroCAT C-T (P) Recorder

Conductivity, Temperature (pressure optional) Recorder with
RS-232 Interface

Manual version
Firmware version
Software versions

- 033
- 3.1 & later
- Seaterm V2 2.4.1 & later
- SBE Data Processing 7.23.2 & later

CE



Sea-Bird Electronics
13431 NE 20th Street
Bellevue, Washington
98005 USA

Tel: +1 425-643-9866
seabird@seabird.com
www.seabird.com

Limited Liability Statement

Extreme care should be exercised when using or servicing this equipment. It should be used or serviced only by personnel with knowledge of and training in the use and maintenance of oceanographic electronic equipment.

SEA-BIRD ELECTRONICS, INC. disclaims all product liability risks arising from the use or servicing of this system. SEA-BIRD ELECTRONICS, INC. has no way of controlling the use of this equipment or of choosing the personnel to operate it, and therefore cannot take steps to comply with laws pertaining to product liability, including laws which impose a duty to warn the user of any dangers involved in operating this equipment. Therefore, acceptance of this system by the customer shall be conclusively deemed to include a covenant by the customer to defend, indemnify, and hold SEA-BIRD ELECTRONICS, INC. harmless from all product liability claims arising from the use or servicing of this system.

Declaration of Conformity

Sea-Bird Electronics, Inc.
13431 NE 20th Street, Bellevue, WA 98005 USA

DECLARATION OF CONFORMITY

Manufacturer's Name: Sea-Bird Electronics
Manufacturer's Address: 13431 NE 20th Street
Bellevue, WA 98005, USA

The Authorized Representative located within the Community is:
OTT MESSTECHNIK GmbH & Co.KG
P.O.Box: 2140 / 87411 Kempten / Germany
Ludwigstrasse 16 / 87437 Kempten
Internet: <http://www.ott.com>
Phone: +49 831 5617 – 100
Fax: +49 831 5617 - 209

Device Description: Various Data Acquisition Devices and Sensors

Model Numbers:

3S	3F	3plus	4C	4M	5T	5P	5M	7
8	9plus	11plus	14	16plus V2	16plus-IM V2		17plus V2	18
19plus V2	21	25plus	26plus	27	29	32	32C	32SC
33	35	35RT	36	37-IMP	37-IM	37-SMP	37-SM	37-SIP
37-SI	38	39	39-IM	39plus	41	41CP	43	43F
44	45	49	50	52-MP	53BPR	54	55	56
63	SIM	ICC	IMM	PDIM	AFM	90488	90204	90402
90504	Glider Payload CTD		NIMH Battery Charger and Battery Pack					

Applicable EU Directives: Machinery Directive 98 / 37 /EC
EMC Directive 2004 / 108 /EC
Low Voltage Directive (73 / 23 /EEC) as amended by (93 / 68 /EEC)

Applicable Harmonized Standards:
EN 61326-1:2006 Class A Electrical Equipment for Measurement, Control, and Laboratory Use, EMC Requirement – Part 1: General Requirements
(EN 55011:2007 Group 1, Class A)

EN 61010-1:2001, Safety Requirements for Electrical Equipments for Measurement, Control, and Laboratory Use – Part 1: General Requirements

Declaration based upon compliance to the Essential Requirements and Letter of Opinion from CKC Certification Services, LLC., Notified Body 0976

I, the undersigned, hereby declare that the equipment specified above conforms to the above European Union Directives and Standards.

Authorized Signature: 
Name: Nordeen Larson
Title of Signatory: President
Date: 3 September 2013
Place: Bellevue, WA

Table of Contents

Limited Liability Statement	2
Declaration of Conformity	3
Table of Contents	4
Section 1: Introduction	6
About this Manual	6
Quick Start	6
Unpacking MicroCAT	7
Section 2: Description of MicroCAT	8
System Description	8
Specifications	10
Dimensions and End Cap Connector	11
Cables and Wiring	12
Sample Timing	13
Autonomous Sampling	13
Polled Sampling or Serial Line Sync	13
Section 3: Preparing MicroCAT for Deployment	14
Software Installation	14
Power and Communications Test	14
Test Setup	14
Test	15
Section 4: Deploying and Operating MicroCAT	20
Sampling Modes	20
Polled Sampling	21
Autonomous Sampling	22
Serial Line Sync Sampling	23
Baud Rate, Cable Length, Power, and Data Transmission Rate	24
Timeout Description	26
Command Descriptions	26
Data Formats	40
Setup for Deployment	43
Deployment	43
Recovery	44
Uploading and Processing Data	45
Editing Raw Data File	52
Section 5: Routine Maintenance and Calibration	53
Corrosion Precautions	53
Connector Mating and Maintenance	53
Conductivity Cell Maintenance	54
Pressure Sensor (optional) Maintenance	55
O-Ring Maintenance	55
Handling Instructions for Plastic <i>ShallowCAT</i>	56
Replacing Anti-Foulant Devices (SBE 37-SI, SM, IM)	57
Sensor Calibration	58
Section 6: Troubleshooting	60
Problem 1: Unable to Communicate with MicroCAT	60
Problem 2: No Data Recorded	60
Problem 3: Unreasonable T, C, or P Data	60
Problem 4: Salinity Spikes	61
Glossary	62

Appendix I: Functional Description64
Sensors 64
Sensor Interface 64
Real-Time Clock..... 64
Memory..... 65

Appendix II: Electronics Disassembly/Reassembly66

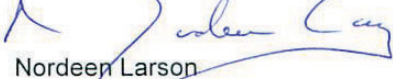
Appendix III: Command Summary68

Appendix IV: AF24173 Anti-Foulant Device.....71

Appendix V: Replacement Parts75

Appendix VI: Manual Revision History77

Index.....80

Section 1: Introduction

This section includes a Quick Start procedure, and photos of a typical MicroCAT shipment.

About this Manual

This manual is to be used with the SBE 37-SI MicroCAT Conductivity and Temperature Sensor (pressure optional) with **RS-232** interface. It is organized to guide the user from installation through operation and data collection. We've included detailed specifications, command descriptions, maintenance and calibration information, and helpful notes throughout the manual.

Sea-Bird welcomes suggestions for new features and enhancements of our products and/or documentation. Please contact us with any comments or suggestions (seabird@seabird.com or 425-643-9866). Our business hours are Monday through Friday, 0800 to 1700 Pacific Standard Time (1600 to 0100 Universal Time) in winter and 0800 to 1700 Pacific Daylight Time (1500 to 0000 Universal Time) the rest of the year.

Quick Start

Follow these steps to get a Quick Start using the MicroCAT. The manual provides step-by-step details for performing each task:

1. Perform pre-check procedures to test power and communications (*Section 3: Preparing MicroCAT for Deployment*):
2. Deploy MicroCAT (*Section 4: Deploying and Operating MicroCAT*):
 - A. Set date and time (**DateTime=**).
 - B. Ensure all data has been uploaded, and then send **InitLogging** to make entire memory available for recording if desired.
 - C. Establish setup and operating parameters.
 - D. Check status (**DS**) and calibration coefficients (**DC**) to verify setup.
 - E. Remove protective plugs from anti-foulant device cups, and verify AF24173 Anti-Foulant Devices are installed. Leave protective plugs off for deployment.
 - F. Install I/O cable connector and locking sleeve.
 - G. Deploy MicroCAT, using optional Sea-Bird mounting hardware or customer-supplied hardware.
 - H. If desired, save real-time data to a file, using Seaterm232's Capture function or your own software.
 - I. Upload data from memory.

Unpacking MicroCAT

Shown below is a typical MicroCAT shipment.

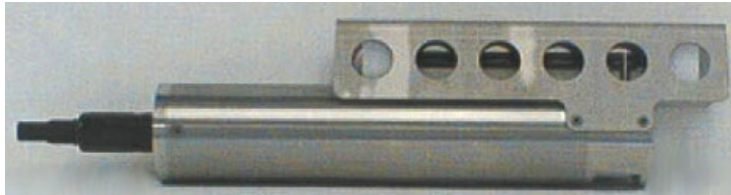

SBE 37-SI MicroCAT



I/O cable



Spare hardware and o-ring kit



Conductivity cell cleaning solution (Triton-X)



Software, and Electronic Copies of Software Manuals and User Manual

Section 2: Description of MicroCAT

This section describes the functions and features of the SBE 37-SI MicroCAT, including specifications, dimensions, end cap connector, and sample timing.

System Description



Titanium housing

Plastic ShallowCAT housing

The SBE 37-SI MicroCAT is a high-accuracy, externally powered, conductivity and temperature (pressure optional) sensor with non-volatile memory, which includes an **RS-232** serial interface. Constructed of non-corroding materials for long life with minimal maintenance, the MicroCAT is useful as a stand-alone monitoring device (external power required), and is easily integrated with other instrumentation platforms. The MicroCAT is rated for operation to 350 meters (plastic *ShallowCAT* housing) or 7000 meters (titanium housing), or pressure sensor full-scale range.

Communication with the MicroCAT is over an internal, 3-wire, RS-232C link. Over 50 different commands can be sent to the MicroCAT to provide status display, data acquisition setup, data retrieval, and diagnostic tests. User-selectable operating modes include:

- **Autonomous sampling** – There are two types of Autonomous sampling.
 - Interval sampling:* At pre-programmed intervals (6 – 21,600 seconds), the MicroCAT samples, stores data in its FLASH memory, and transmits the data to the computer. The MicroCAT goes to sleep between samples.
 - Continuous sampling:* The MicroCAT continuously samples, stores data in its FLASH memory, and sends the data to the computer. The MicroCAT does not go to sleep between samples.
- **Polled sampling** – On command, the MicroCAT takes one sample and transmits the data. Polled sampling is useful for integrating the MicroCAT with satellite, radio, or wire telemetry equipment.
- **Serial line sync** - A pulse on the serial line causes a MicroCAT to wake up, sample, store data in its FLASH memory, transmit the data, and go to sleep automatically. This mode provides easy integration with Acoustic Doppler Current Profilers (ADCPs) or current meters which can synchronize MicroCAT sampling with their own.

Calibration coefficients stored in EEPROM allow the MicroCAT to transmit data in engineering units. The MicroCAT retains the temperature and conductivity sensors used in the Seacat and Seacat *plus* family. The MicroCAT's aged and pressure protected thermistor has a long history of exceptional accuracy and stability (typical drift is less than 0.002 °C per year). Electrical isolation of the conductivity electronics eliminates any possibility of ground-loop noise.

The MicroCAT's internal-field conductivity cell is immune to proximity errors and unaffected by external fouling. A plastic cup with threaded cover at each end of the cell retains the expendable AF24173 Anti-Foulant Device.

The MicroCAT's optional strain-gauge pressure sensor is available in the following pressure ranges: 20, 100, 350, 600, 1000, 2000, 3500, and 7000 meters. Compensation of the temperature influence on pressure offset and scale is performed by the MicroCAT's CPU.

Future upgrades and enhancements to the MicroCAT firmware can be easily installed in the field through a computer serial port and the bulkhead connector on the MicroCAT, without the need to return the MicroCAT to Sea-Bird.

Notes:

- Help files provide detailed information on the software.
- A separate software manual on CD-ROM contains detailed information on the setup and use of SBE Data Processing.
- Sea-Bird supplies the current version of our software when you purchase an instrument. As software revisions occur, we post the revised software on our website. See our website for the latest software version number, a description of the software changes, and instructions for downloading the software.

The MicroCAT is supplied with a powerful Windows software package, Seasoft[®] V2, which includes:

- **SeatermV2** – terminal program for easy communication and data retrieval. SeatermV2 is a *launcher*, and launches the appropriate terminal program for the selected instrument (**Seaterm232** for RS-232 instruments such as this MicroCAT).
- **SBE Data Processing** - program for calculation and plotting of conductivity, temperature, pressure (optional), and derived variables such as salinity and sound velocity.

Specifications

Note:

Pressure ranges are expressed in meters of deployment depth capability.

	Temperature (°C)	Conductivity (S/m)	Optional Pressure						
Measurement Range	-5 to +45	0 to 7 (0 to 70 mS/cm)	0 to full scale range: 20 / 100 / 350 / 600 / 1000 / 2000 / 3500 / 7000 meters						
Initial Accuracy	± 0.002 (-5 to 35 °C); ± 0.01 (35 to 45 °C)	± 0.0003 (0.003 mS/cm)	± 0.1% of full scale range						
Typical Stability	0.0002 per month	0.0003 (0.003 mS/cm) per month	0.05% of full scale range per year						
Resolution *	0.0001	0.00001 (0.0001 mS/cm)	0.002% of full scale range						
Sensor Calibration	+1 to +32	0 to 6; physical calibration over the range 2.6 to 6 S/m, plus zero conductivity (air)	Ambient pressure to full scale range in 5 steps						
Memory	8 Mbyte non-volatile FLASH memory								
Data Storage	Conductivity & temperature: 6 bytes/sample (3 bytes each). Time: 4 bytes/sample. Pressure (optional): 5 bytes/sample								
	<table border="0"> <thead> <tr> <th><u>Recorded Parameters</u></th> <th><u>Memory Space (# of samples)</u></th> </tr> </thead> <tbody> <tr> <td>C, T, and time</td> <td>800,000</td> </tr> <tr> <td>C, T, P, and time</td> <td>533,000</td> </tr> </tbody> </table>			<u>Recorded Parameters</u>	<u>Memory Space (# of samples)</u>	C, T, and time	800,000	C, T, P, and time	533,000
<u>Recorded Parameters</u>	<u>Memory Space (# of samples)</u>								
C, T, and time	800,000								
C, T, P, and time	533,000								
Real-Time Clock	32,768 Hz TCXO accurate to ±1 minute/year.								
External Input Power	0.5 Amps at 8.5-24 VDC. See <i>Power and Cable Length</i> in <i>Section 4: Deploying and Operating MicroCAT</i> . <ul style="list-style-type: none"> • Quiescent current: 30 microamps • Communication current: 4.3 milliamps • Acquisition current: 15 milliamps • Minimum acquisition time (continuous sampling): 1.0 seconds/sample without pressure; 1.5 seconds/sample with pressure. 								
Housing and Depth Rating	Titanium housing, 7000 m (23,000 ft) Plastic <i>ShallowCAT</i> housing, 350 m (1150 ft)								
Weight (without pressure sensor or clamps)	<i>Titanium housing:</i> In air: 2.9 kg (6.5 lbs) In water: 1.9 kg (4.3 lbs) <i>Plastic ShallowCAT housing:</i> In air: 2.2 kg (4.9 lbs) In water: 1.2 kg (2.7 lbs)								

CAUTION:

See *Section 5: Routine Maintenance and Calibration* for handling instructions for the plastic *ShallowCAT* housing.

***Resolution**

Typical RMS noise with fixed resistors on temperature and conductivity inputs is 0.000127 °C and 0.000008 S/m.

Dimensions and End Cap Connector

Dimensions in millimeters (inches)

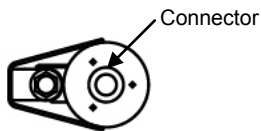
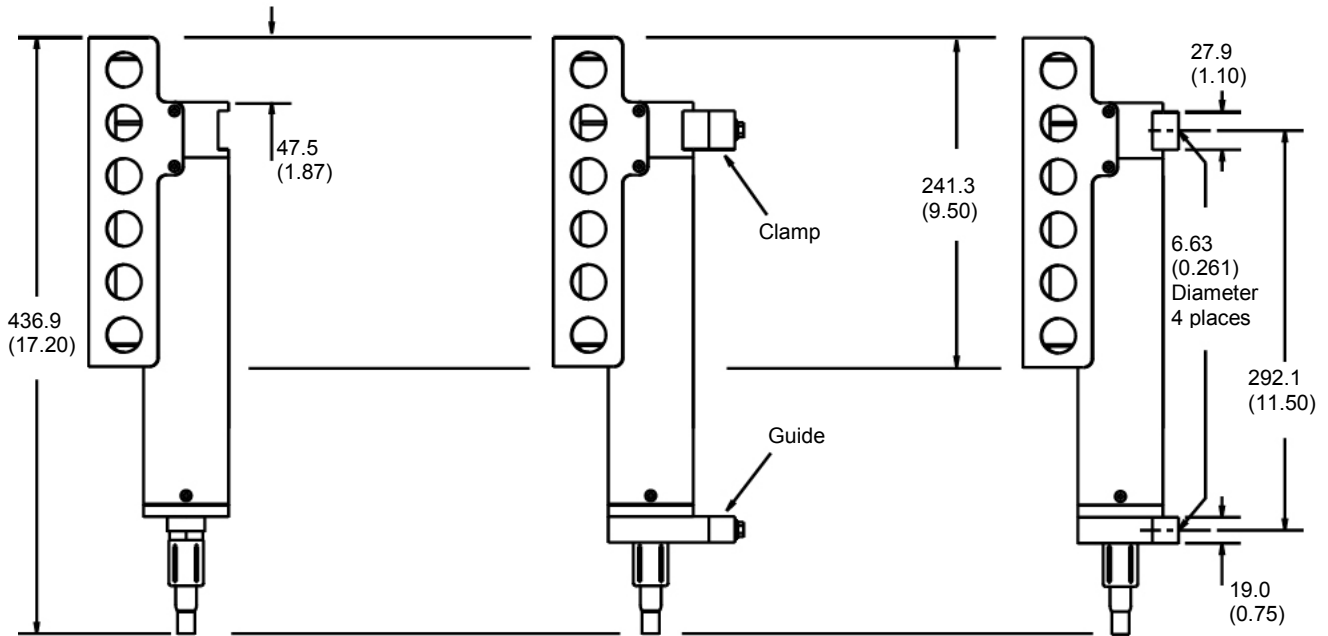
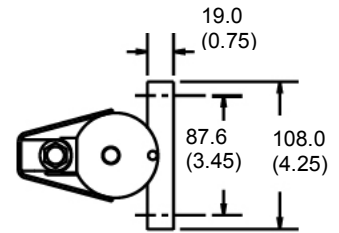
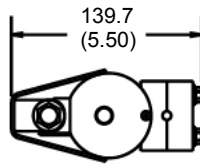
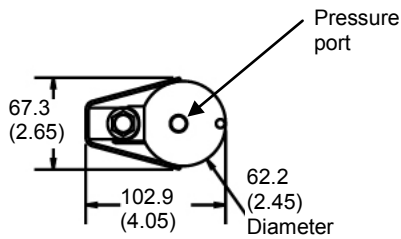

Without Mounting Hardware



Wire Mounting Clamp and Guide

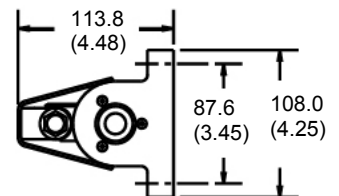

Flat Surface Mounting Brackets

Wet-Pluggable
MCBH-4MP (WB), TI
(3/8" length base,
1/2-20 thread)

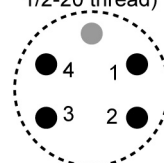
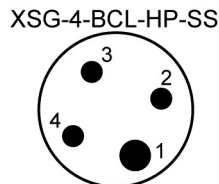

- | Pin | Signal |
|-----|-----------------------------|
| 1 | Common |
| 2 | RS-232 data receive |
| 3 | RS-232 data transmit |
| 4 | 8.5 - 24 VDC external power |

Cables and Wiring

RMG Connector Cable Wiring -- DN 32277

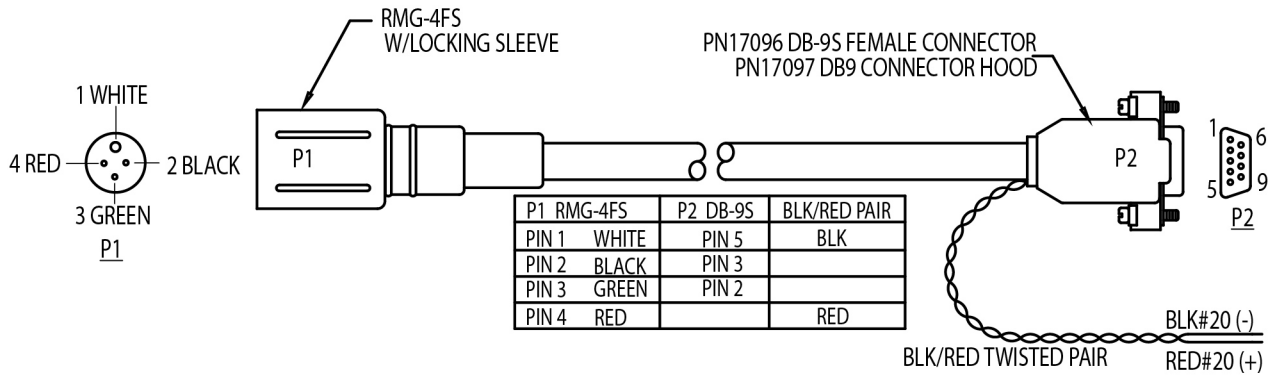

MCIL Wet-Pluggable Connector Cable Wiring -- DN 32366

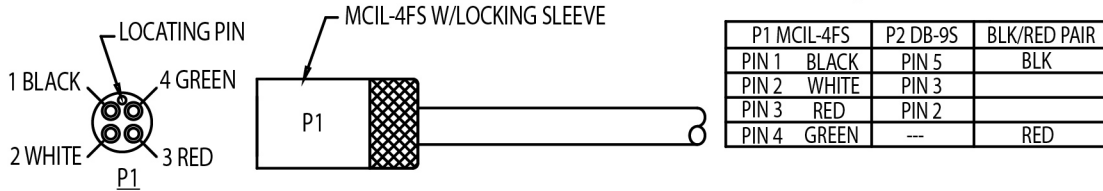

172293, DF11 CONNECTOR, 6 PIN

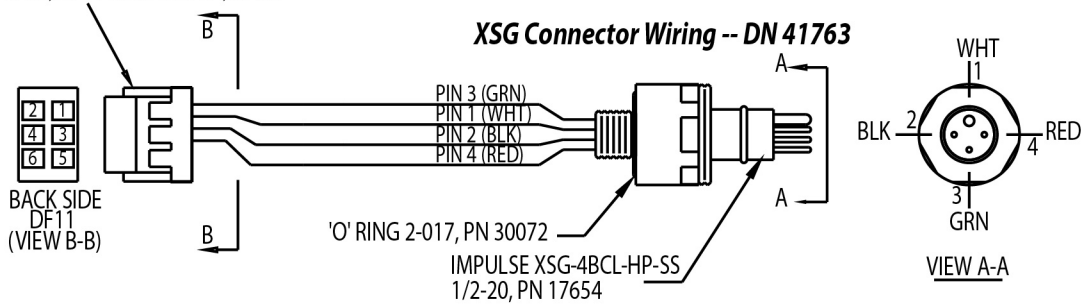

XSG Connector Wiring -- DN 41763

DF11 CONNECTOR	BULKHEAD CONNECTOR	FUNCTION
PIN 1	PIN 3 (GRN)	TX TO PC
PIN 2	PIN 1 (WHT)	COMMON
PIN 3	PIN 2 (BLK)	RX FROM PC
PIN 4	PIN 4 (RED)	EXTERNAL PWR
PIN 5		
PIN 6		

MCBH Wet-Pluggable Connector Wiring -- DN 41762

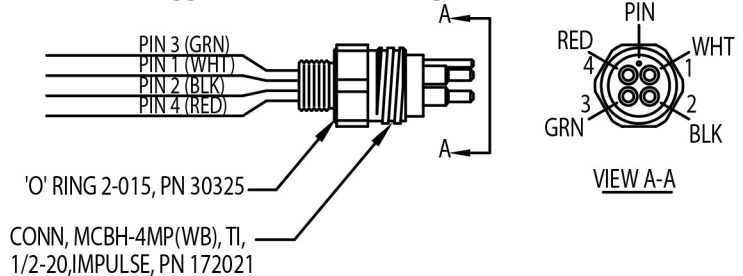

Sample Timing

Notes:

- Time output and stored with the data is the time at the **start** of the sample, after a small amount of time for the MicroCAT to wake up and prepare to sample. For example, if the MicroCAT is programmed to wake up and sample at 12:00:00, the stored and displayed time will indicate 12:00:01 or 12:00:02.
- See *Section 4: Deploying and Operating MicroCAT* for command descriptions.

Note:

Autonomous Sampling is in effect when:

- **AutoRun=Y** and **SampleMode=2** or **3**, or
 - **AutoRun=N** and **SampleMode=2** or **3**, and sampling is started with **Start**
- The MicroCAT goes to sleep between samples when sampling at pre-defined intervals (**SampleMode=2**).

Note:

Polled Sampling is in effect when:

- Sampling is started with a polled sampling command (**TS**, etc.).

Serial Line Sync is in effect when:

- **AutoRun=N**, **SampleMode=1**, sampling is started with **Start**, and another sample is obtained each time a pulse is received, until **Stop** is sent.
- **AutoRun=Y**, **SampleMode=1**, sampling is started by applying power, and another sample is obtained each time a pulse is received, until **Stop** is sent.

Sample timing is dependent on several factors, including:

- Sampling mode – autonomous (interval or continuous sampling), polled, or serial line sync
- Inclusion of optional pressure sensor in MicroCAT
- Number of characters of data transmitted -
The MicroCAT transmits data **after** it completes the previous sample and **before** it starts the next sample. Add transmission time to sampling time to determine the minimum time between samples; see *Baud Rate, Cable Length, Power, and Data Transmission Rate* in *Section 4: Deploying and Operating MicroCAT*.

Autonomous Sampling

Interval Sampling (**SampleMode=2**), taking a sample every **SampleInterval=** seconds:

- **Without pressure**
power-on time for each sample = 1.8 seconds
- **With pressure**
power-on time for each sample = 2.4 seconds

Continuous Sampling (**SampleMode=3**):

- **Without pressure**
sampling time = 1.0 seconds
- **With pressure**
sampling time = 1.5 seconds

Polled Sampling or Serial Line Sync

Time from end of take sample command to beginning of reply:

- **Without pressure**
power-on time for each sample = 2.0 seconds
- **With pressure**
power-on time for each sample = 2.6 seconds

Section 3:

Preparing MicroCAT for Deployment

This section describes the pre-check procedure for preparing the MicroCAT for deployment, including installing software and testing power and communications.

Software Installation

Notes:

- Help files provide detailed information on the software. A separate software manual on the CD-ROM contains detailed information on SBE Data Processing.
- It is possible to use the MicroCAT without the SeatermV2 terminal program by sending direct commands from a dumb terminal or terminal emulator, such as Windows HyperTerminal.
- Sea-Bird supplies the current version of our software when you purchase an instrument. As software revisions occur, we post the revised software on our website. See our website for the latest software version number, a description of the software changes, and instructions for downloading the software.

Seasoft V2 was designed to work with a PC running Windows XP service pack 2 or later, Windows Vista, or Windows 7 (32-bit or 64-bit).

If not already installed, install Sea-Bird software programs on your computer using the supplied software CD:

1. Insert the CD in your CD drive.
2. Install software: Double click on **SeasoftV2.exe**. Follow the dialog box directions to install the software. The installation program allows you to install the desired components. Install all the components, or just install SeatermV2 (terminal program *launcher* for the MicroCAT) and SBE Data Processing (data processing).

The default location for the software is c:\Program Files\Sea-Bird. Within that folder is a sub-directory for each program.

Power and Communications Test

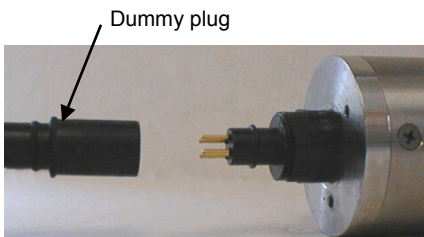
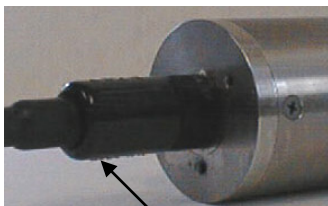

The power and communications test will verify that the system works, prior to deployment.

Test Setup

1. Remove the dummy plug:
 - A. By hand, unscrew the locking sleeve from the MicroCAT's bulkhead connector. **If you must use a wrench or pliers, be careful not to loosen the bulkhead connector instead of the locking sleeve.**
 - B. Remove the dummy plug from the MicroCAT's I/O bulkhead connector by pulling the plug firmly away from the connector.
2. Install the Sea-Bird I/O cable connector:

XSG Connector - Install the Sea-Bird I/O cable connector, aligning the raised bump on the side of the connector with the large pin (pin 1 - ground) on the MicroCAT (XSG connector shown below). **OR**

MCBH Connector – Install the I/O cable connector, aligning the pins.
3. Connect the I/O cable connector to your computer's serial port.
4. Connect the I/O cable connector's red (+) and black (-) wires to a power supply (8.5-24 VDC).

Note:
See SeatermV2's Help files.

Test

1. Double click on **SeatermV2.exe**. The main screen looks like this:

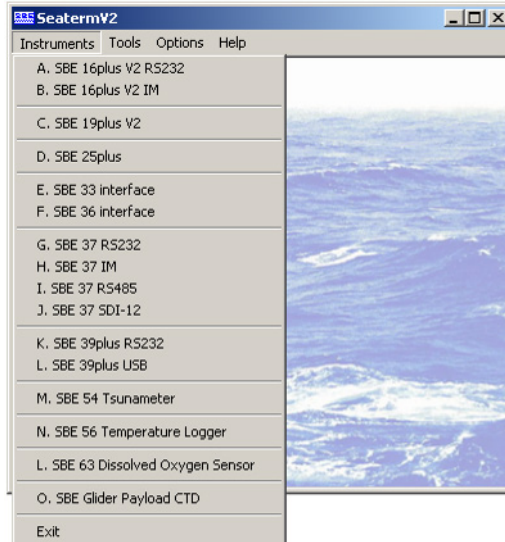

SeatermV2 is a *launcher*, and launches the appropriate terminal program for the selected instrument.

Note:
See Seaterm232's Help files.

2. In the Instruments menu, select *SBE 37 RS232*. **Seaterm232** opens; the main screen looks like this:

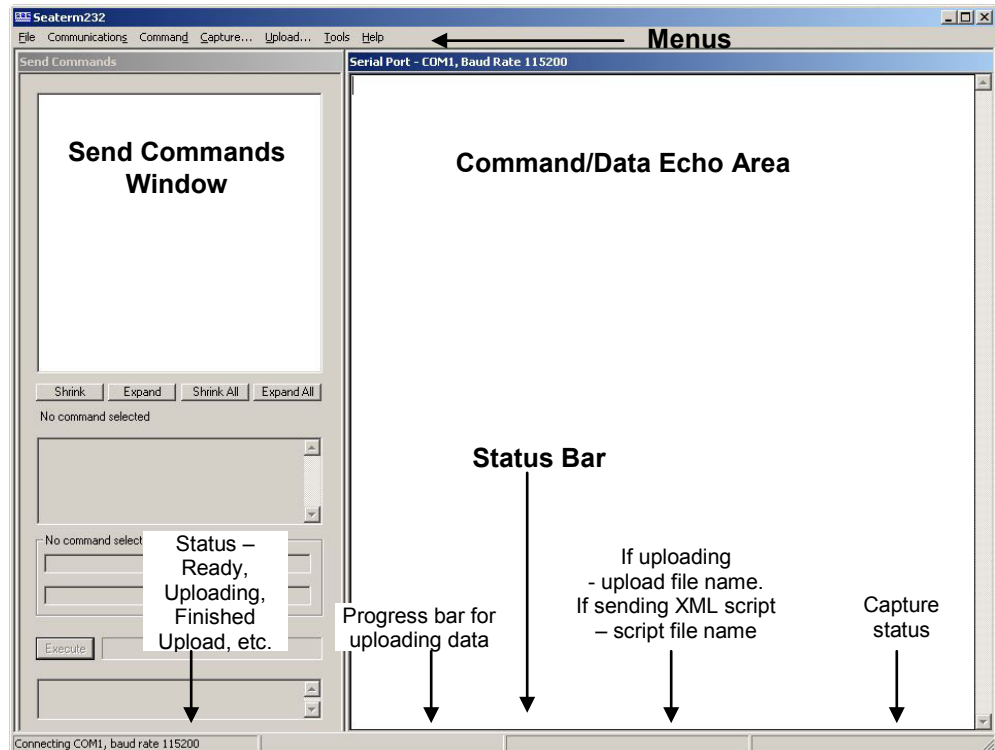

- **Menus** – For tasks and frequently executed instrument commands.
- **Send Commands window** – Contains commands applicable to your MicroCAT. The list appears after you connect to the MicroCAT.
- **Command/Data Echo Area** – Title bar of this window shows Seaterm232's current comm port and baud rate. Commands and the MicroCAT responses are echoed here. Additionally, a command can be manually typed or pasted (ctrl + V) here. Note that the MicroCAT must be *connected* and *awake* for it to respond to a command.
- **Status bar** – Provides connection, upload, script, and capture status information.

Following is a description of the menus:

Menu	Description	Equivalent Command*
File	<ul style="list-style-type: none"> • Load command file – opens selected .XML command file, and fills Send Commands window with commands. • Unload command file – closes command file, and removes commands from Send Commands window. • Exit - Exit program. 	-
Communications	<ul style="list-style-type: none"> • Configure – Establish communication parameters (comm port and baud rate). • Connect – connect to comm port. • Disconnect – disconnect from comm port. • Disconnect and reconnect – may be useful if instrument has stopped responding. 	-
Command	<ul style="list-style-type: none"> • Abort – interrupt and stop MicroCAT’s response. • Send 5 second break (for use with Serial Line Sync mode). • Send stop command. • Set local time– Set date and time to time sent by timekeeping software on your computer; accuracy ± 25 msec of time provided by computer. • Set UTC Time (Greenwich Mean Time) – Set date and time to time sent by timekeeping software on your computer; accuracy ± 25 msec of time provided by computer. 	<ul style="list-style-type: none"> • (press Esc key several times for Abort) • Stop • DateTime= • DateTime=
Capture	Capture instrument responses on screen to file, to save real-time data or use for diagnostics. File has .cap extension. Click Capture menu again to turn off capture. Capture status displays in Status bar.	—
Upload	Upload data stored in memory, in a format that Sea-Bird’s data processing software can use. Uploaded data has .xml extension, and is then automatically converted to a .hex and a .xmlcon file that can be used in SBE Data Processing’s Data Conversion module. Before using Upload: stop logging by sending Stop .	Several status commands and appropriate data upload command as applicable to user selection of range of data to upload (use Upload menu if you will be processing data with SBE Data Processing)
Tools	<ul style="list-style-type: none"> • Diagnostics log - Keep a diagnostics log. • Convert .XML data file – Using Upload menu automatically does this conversion; tool is available if there was a problem with the automatic conversion. • Send script – Send XML script to MicroCAT. May be useful if you have a number of MicroCATs to program with same setup. 	-

Note:
Set local time and *Set UTC time* are disabled if the baud rate in Seaterm232 is set to 115200, because the software cannot reliably set the time at that baud.

Note:
 SeatermV2 with version < 1.1 did not convert the uploaded .xml data file to a .hex and .xmlcon file. *Convert .XML data file* in the Tools menu was used to convert the .xml data file to a .cnv file, which could be processed in SBE Data Processing. We recommend that you update your SeatermV2 software to 1.1b or later.

*See Command Descriptions in Section 4: Deploying and Operating MicroCAT.

3. If this is the first time Seaterm232 is being used, the configuration dialog box displays:

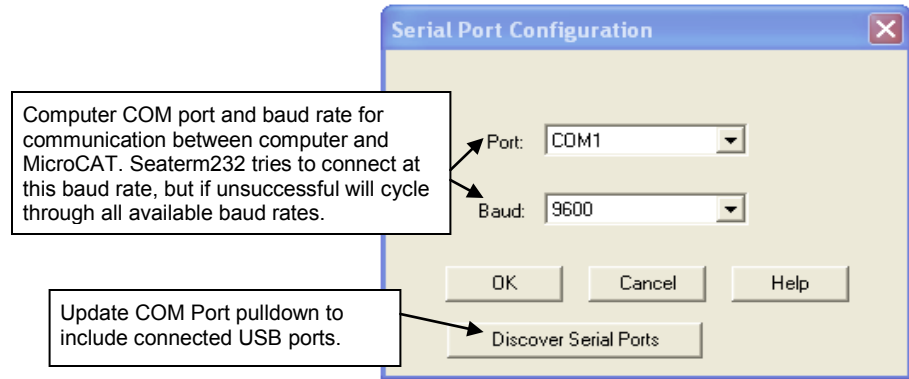

Make the desired selections, and click OK.

Note:

Seaterm232's baud rate must be the same as the MicroCAT baud rate (set with **BaudRate=**). Baud is factory-set to 9600, but can be changed by the user (see *Command Descriptions* in *Section 4: Deploying and Operating MicroCAT*). Other communication parameters – 8 data bits, 1 stop bit, and no parity – cannot be changed.

4. Seaterm232 tries to automatically connect to the MicroCAT. As it connects, it sends **GetHD** and displays the response, which provides factory-set data such as instrument type, serial number, and firmware version. Seaterm232 also fills the Send Commands window with the correct list of commands for your MicroCAT.

If there is no communication:

- A. In the Communications menu, select *Configure*. The Serial Port Configuration dialog box appears. Select the Comm port and baud rate for communication, and click OK. Note that the factory-set baud rate is documented on the Configuration Sheet.
- B. In the Communications menu, select *Connect* (if *Connect* is grayed out, select *Disconnect and reconnect*). Seaterm232 will attempt to connect at the baud specified in Step A, but if unsuccessful will then cycle through all other available baud rates.
- C. If there is still no communication, check cabling between the computer and MicroCAT, and try to connect again.
- D. If there is still no communication, repeat Step A with a different comm port, and try to connect again.

Note:

If **OutputExecutedTag=Y**, the MicroCAT does **not** provide an S> prompt after the <Executed/> tag at the end of a command response.

After Seaterm232 displays the **GetHD** response, it provides an S> prompt to indicate it is ready for the next command.

Taking a look at the Send Commands window:

Note:
The Send Commands window includes commands for pump setup because the 37-SIP (pumped MicroCAT) uses the same firmware as the 37-SI. However, these commands are not applicable to the 37-SI.

Click on desired command description in list.

Help box describes selected command in more detail.

Enter any command arguments (such as starting and ending sample number for upload) in these boxes.

Click Execute when ready to send selected command.

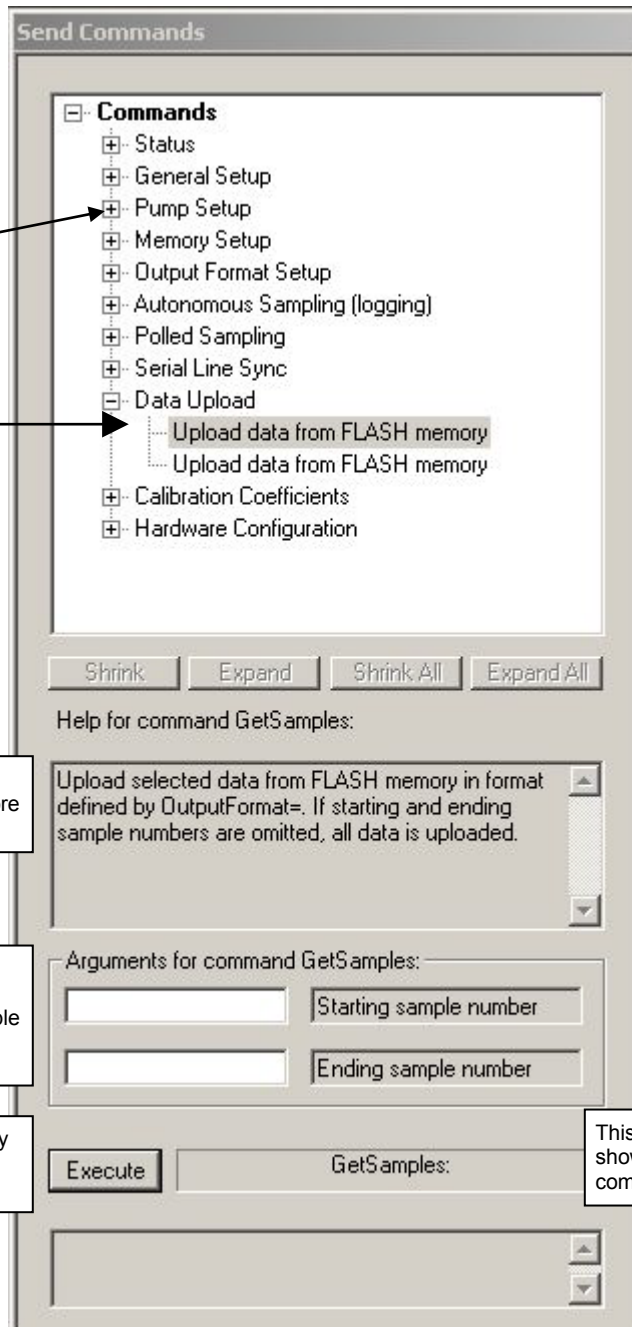

This box shows selected command.

You can use the Send Commands window to send commands, or simply type the commands in the Command/Data Echo area if desired.

Notes:

- You may need to send the **Stop** command (type **Stop** and press the Enter key) to interrupt sampling, depending on how the instrument was set up the last time it was used. You may need to send **Stop** several times to get the MicroCAT to respond.
- The MicroCAT automatically enters quiescent (sleep) state after 2 minutes without receiving a command. This timeout algorithm is designed to draw minimal current if the user does not send **QS** to put the MicroCAT to sleep. If the system does not appear to respond, select *Connect* in the Communications menu to reestablish communications.

5. Display MicroCAT status information by typing **DS** and pressing the Enter key. The display looks like this:

```
SBE37SI-RS232 3.1 SERIAL NO. 6017 20 Oct 2012 00:48:50
vMain = 7.41, vLith = 3.16
samplenum = 0, free = 559240
status = not logging
sample interval = 15 seconds
data format = converted engineering
output time
sample mode = interval sample
auto run = no
store data = yes
pump installed = no
```

6. Command the MicroCAT to take a sample by typing **TS** and pressing the Enter key. The display looks like this (if pressure sensor installed, **OutputFormat=1**, **OutputTime=Y**, and you are not outputting salinity, sound velocity, density, or depth):

```
23.7658, 0.00019, 0.062, 20 Oct 2012, 00:51:30
where 23.7658 = temperature in degrees Celsius
0.00019 = conductivity in S/m
0.062 = pressure in decibars
20 Oct 2012 = date
00:51:30 = time
```

These numbers should be reasonable; i.e., room temperature, zero conductivity, barometric pressure (gauge pressure).

7. Command the MicroCAT to go to sleep (quiescent state) by typing **QS** and pressing the Enter key.

The MicroCAT is ready for programming and deployment.

Section 4:

Deploying and Operating MicroCAT

This section includes:

- System operation with example sets of operation commands
- Baud rate, cable length, power, and data transmission rate limitations
- Timeout description
- Command descriptions
- Data output formats
- Deployment
- Recovery – physical handling and uploading data
- Processing data

Note:

Separate software manuals and Help files contain detailed information on installation, setup, and use of Sea-Bird's software.

Sampling Modes

Note:

After waking the MicroCAT, you may need to send the **Stop** command (type **Stop** and press the Enter key) to interrupt sampling, depending on how the instrument was set up the last time it was used. You may need to send **Stop** several times to get the MicroCAT to respond.

The MicroCAT has several basic sampling modes for obtaining data:

- Polled Sampling
- Autonomous Sampling – Interval or Continuous
- Serial Line Sync Sampling

Data is transmitted real-time. For Autonomous sampling or Serial Line Sync sampling, data can also be saved to the MicroCAT's FLASH memory (for later upload) by setting **StoreData=Y**. Commands can be used in various combinations to provide a high degree of operating flexibility.

Removing external power from the MicroCAT corrupts a small amount of data in the MicroCAT's memory (but the real-time data is unaffected); see *Memory* in *Appendix I: Functional Description* for details. **Therefore, a deployment where power is completely removed between sets of samples (for example, applying power to sample autonomously for a short time and then removing power) will not provide reliable data in memory, unless the data in memory is uploaded before removing power.**

Descriptions and examples of the modes follow. Note that the MicroCAT's response to each command is not shown in the examples. Review the operation of the basic sampling modes and the commands described in *Command Descriptions* before setting up your system.

Polled Sampling

On command, the MicroCAT takes one sample of data and sends the data to the computer. Storing of data in the MicroCAT's FLASH memory is dependent on the particular command used.

*Example: **Polled Sampling*** (user input in bold).

Wake up MicroCAT. Set up to wait for command each time it wakes up, send data in converted decimal format, send date and time and salinity with data. Send power-off command. Assuming that power is always applied:

(Select *Connect* in Seaterm232's Communications menu to connect and wake up.)

AUTORUN=N

OUTPUTFORMAT=1

OUTPUTTIME=Y

OUTPUTSAL=Y

GETCD (to verify setup)

QS

When ready to take a sample (repeat as desired): wake up MicroCAT, command it to take a sample and output data, and send power-off command.

(Before first sample, click Capture menu to capture data to a file – Seaterm232 requests file name for data to be stored.)

(Select *Connect* in Seaterm232's Communications menu to connect and wake up.)

TS

QS

Autonomous Sampling

Autonomous Sampling includes both Interval and Continuous Sampling:

- **Interval sampling (SampleMode=2)** - MicroCAT samples at the programmed interval (**SampleInterval=**) and sends data, and goes to sleep between samples.
- **Continuous sampling (SampleMode=3)** - MicroCAT samples at the fastest rate possible for the selected parameters (see *Sample Timing* in *Section 2: Description of MicroCAT*). MicroCAT continuously samples and sends data, and does not go to sleep between samples.

Keep the signal line open circuit or within ± 0.3 V relative to ground to minimize power consumption when not trying to send commands.

Examples: Autonomous Sampling - both examples illustrate interval sampling; setup for continuous sampling is similar (but set **SampleMode=3** instead of 2; MicroCAT ignores any entry for **SampleInterval=** in continuous mode).

Example 1: AutoRun=N (user input in bold) - Set up to take a sample every 20 seconds, store data in memory, output data in converted decimal format, and send date and time with data. Send power-off.

(Apply power. Select *Connect* in Seaterm232's Communications menu to connect and wake up.)

```
SAMPLEMODE=2
SAMPLEINTERVAL=20
STOREDATA=Y
OUTPUTFORMAT=1
OUTPUTTIME=Y
AUTORUN=N
GETCD      (to verify setup)
```

QS
(Remove power.)

When ready to begin sampling:

(To save real-time data, click Capture menu to capture data to a file – Seaterm232 requests file name for data to be stored.)

(Apply power, and select *Connect* in Seaterm232's Communications menu to connect and wake up.)

START (MicroCAT takes and transmits sample, stores in memory, and repeats sequence every 20 seconds.)

When ready to stop sampling and go to sleep:

(Press any key)

STOP

(Click Upload menu – Seaterm232 leads you through screens to define data to be uploaded and where to store it.)

QS

Example 2: AutoRun=Y (user input in bold) - Set up to take a sample every 20 seconds, store data in memory, output data in converted decimal format, and send date and time with data. Remove power.

(Apply power to wake up.)

```
SAMPLEMODE=2
SAMPLEINTERVAL=20
STOREDATA=Y
OUTPUTFORMAT=1
OUTPUTTIME=Y
AUTORUN=Y
GETCD      (to verify setup)
```

(Remove power.)

When ready to begin sampling:

(To save real-time data, click Capture menu to capture data to a file – Seaterm232 requests file name for data to be stored.)

(Apply power to wake up – MicroCAT takes and transmits sample, stores in memory, and repeats sequence every 20 seconds.)

When ready to stop sampling:

(Remove power.)

To change setup:

(Apply power to wake up – MicroCAT automatically begins sampling sequence. Press any key.)

STOP

(Click Upload menu – Seaterm232 leads you through screens to define data to be uploaded and where to store it.)

(send desired commands)

(Remove power.)

Serial Line Sync Sampling

For Serial Line Sync, a simple pulse (a single character) on the RS-232 serial line causes a MicroCAT to wake up, sample, transmit data, and go to sleep automatically. This mode provides easy integration with Acoustic Doppler Current Profilers (ADCPs) or current meters, which can synchronize MicroCAT sampling with their own.

Keep the signal line open circuit or within ± 0.3 V relative to ground to minimize power consumption when not trying to send a pulse to take a sample.

Examples: Serial Line Sync

Example 1: **AutoRun=N** (user input in bold)

Set up to take 1 sample when prompted, store data in memory, and send date and time with data. Send power-off command.

(Select *Connect* in Seaterm232's Communications menu to connect and wake up.)

SAMPLEMODE=1

STOREDATA=Y

OUTPUTTIME=Y

AUTORUN=N

GETCD (to verify setup)

QS

(Remove power.)

When ready to begin sampling:

(To save real-time data, click Capture menu to capture data to a file – Seaterm232 requests file name for data to be stored.)

(Apply power, and press any key to wake up)

START (MicroCAT takes and transmits 1 sample, stores in memory, and goes to sleep.)

When ready to take another sample, send a pulse (press any key) to wake up, take and transmit 1 sample, store in memory, and go to sleep. Repeat as desired.

When ready to stop sampling and go to sleep:

(Press any key).

STOP

(Click Upload menu – Seaterm232 leads you through screens to define data to be uploaded and where to store it.)

QS

Example 2: **AutoRun=Y** (user input in bold)

Set up to take 1 sample when prompted, store data in memory, and send date and time with data. Remove power.

(Apply power to wake up.)

SAMPLEMODE=1

STOREDATA=Y

OUTPUTTIME=Y

AUTORUN=Y

GETCD (to verify setup)

Remove power.

When ready to begin sampling:

(To save real-time data, click Capture menu to capture data to a file – Seaterm232 requests file name for data to be stored.)

(Apply power– MicroCAT takes and transmits 1 sample, stores in memory, and goes to sleep.)

When ready to take another sample, send a pulse (press any key) to wake up, take and transmit 1 sample, store in memory, and go to sleep. Repeat as desired.

When ready to stop sampling:

(Remove power.)

To change setup, temporarily disable serial line sync:

(Apply power – MicroCAT automatically begins the sampling sequence. Press any key.)

STOP

(Click Upload menu – Seaterm232 leads you through screens to define data to be uploaded and where to store it.)

(send desired commands)

Remove power.

Baud Rate, Cable Length, Power, and Data Transmission Rate

If acquiring real-time data with Seaterm232, click the Capture menu; enter the desired file name in the dialog box, and click Save. Begin sampling. The data displayed in Seaterm232 will be saved to the designated file. Process the data as desired. Note that this file **cannot be processed by SBE Data Processing, as it does not have the required headers and format for Sea-Bird's processing software.** To process data with SBE Data Processing, upload the data from the MicroCAT's memory.

Baud Rate, Cable Length, and Data Transmission Rate

The rate that data can be transmitted from the MicroCAT is dependent on the amount of data to be transmitted per scan and the serial data baud rate:

Time to transmit data = (number of characters * 10 bits/character) / baud rate

where

number of characters is dependent on the included data and output format (see *Data Formats*). Add 2 to the number of characters shown in the output format, to account for the carriage return and line feed at the end of each scan. Include decimal points, commas, and spaces when counting characters.

Note that the MicroCAT transmits data **after** it has completed the previous sample and **before** it starts the next sample (see *Sample Timing* in *Section 2: Description of MicroCAT*).

The length of cable that the MicroCAT can drive to transmit real-time data is also dependent on baud rate. Check the capability of your computer and terminal program before increasing the baud; high baud requires a short cable and good PC serial port with an accurate clock. The allowable combinations are:

Maximum Cable Length (meters)	Maximum Baud Rate
1600	600
800	1200
400	2400
200	4800
100	9600
50	19200
25	38400
16	57600
8	115200

Example – How long does it take to transmit data over 800 m for a MicroCAT with pressure sensor, **OutputFormat=1, OutputDepth=Y, OutputSal=Y, OutputSV=Y, OutputDensity=Y, and OutputTime=Y** (output depth, salinity, sound velocity, density, date and time as well as C, T, and P)?

With 800 meters of cable, the MicroCAT requires a baud rate of 1200.

Number of characters (see *Data Formats*) = 8(T) + 2(comma & space) + 8(C) + 2(comma & space) + 8(P) + 2(comma & space) + 8(depth) + 2(comma & space) + 8(salinity) + 2(comma & space) + 8(sound velocity) + 2(comma & space) + 8(density) + 2(comma & space) + 11(date) + 2(comma & space) + 8(time) + 2(carriage return & line feed) = 93

Time required to transmit data = (93 characters * 10 bits/character) / 1200 = 0.78 seconds

What is the minimum time between samples for continuous sampling?

From *Sample Timing* in *Section 2: Description of MicroCAT*, for continuous sampling with pressure:

Sampling time = 1.5 seconds

So, minimum time between samples = sampling time + transmission time = 1.5 + 0.78 = 2.28 seconds

Notes:

- Baud rate is set with **BaudRate=**.
 - Output format is set with **OutputFormat=**.
- See *Command Descriptions*.

Power and Cable Length

There are two issues to consider:

- Limiting the communication IR loss to 1 volt; higher IR loss will cause the instrument to transmit data that does not meet the RS-232 communication standard.
- Supplying enough power at the power source so that sufficient power is available at the instrument after considering IR loss.

Each issue is discussed below.

Note:

Common wire resistances:

Gauge	Resistance (ohms/foot)
12	0.0016
14	0.0025
16	0.0040
18	0.0064
19	0.0081
20	0.0107
22	0.0162
24	0.0257
26	0.0410
28	0.0653

Limiting Communication IR Loss to 1 Volt

The limit to cable length is typically reached when the maximum **communication** current times the power common wire resistance is more than 1 volt.

$$V_{\text{limit}} = 1 \text{ volt} = IR_{\text{limit}}$$

$$\text{Maximum cable length} = R_{\text{limit}} / \text{wire resistance per foot}$$

where I = communication current required by MicroCAT (4.3 milliamps; see *Specifications* in *Section 2: Description of MicroCAT*).

Example 1 – For 20 gauge wire, what is maximum distance to transmit power to MicroCAT when considering communication IR loss?

For 4.3 milliamp communications current, $R_{\text{limit}} = V_{\text{limit}} / I = 1 \text{ volt} / 0.0043 \text{ Amps} = 232 \text{ ohms}$

For 20 gauge wire, resistance is 0.0107 ohms/foot.

Maximum cable length = $232.6 \text{ ohms} / 0.0107 \text{ ohms/foot} = 21734 \text{ feet} = 6626 \text{ meters}$

Example 2 – Same as above, but there are 4 MicroCATs powered from the same power supply.

For 35 milliamp communications current, $R_{\text{limit}} = V_{\text{limit}} / I = 1 \text{ volt} / (0.0043 \text{ Amps} * 4 \text{ MicroCATs}) = 58 \text{ ohms}$

For 20 gauge wire, resistance is 0.0107 ohms/foot.

Maximum cable length = $58 \text{ ohms} / 0.0107 \text{ ohms/foot} = 5433 \text{ feet} = 1656 \text{ meters}$ (to MicroCAT *furthest* from power source).

Supplying Enough Power to MicroCAT

Another consideration in determining maximum cable length is supplying enough power at the power source so that sufficient voltage is available, after IR loss in the cable (**from the 0.5 Amp turn-on transient, two-way resistance**), to power the MicroCAT. Provide at least 8.5 volts, after IR loss.

$$V - IR \geq 8.5 \text{ volts}$$

where I = MicroCAT turn-on transient (0.5 Amps; see *Specifications*).

Example 1 – For 20 gauge wire, what is maximum distance to transmit power to MicroCAT if using 12 volt power source?

$$V - IR \geq 8.5 \text{ volts} \quad 12 \text{ volts} - (0.50 \text{ Amps}) * (0.0107 \text{ ohms/foot} * 2 * \text{cable length}) \geq 8.5 \text{ volts}$$

$$3.5 \text{ volts} \geq (0.50 \text{ Amps}) * (0.0107 \text{ ohms/foot} * 2 * \text{cable length}) \quad \text{Cable length} \leq 327 \text{ ft} = 99 \text{ meters}$$

Note that 99 meters << 6626 meters (maximum distance when considering communication IR loss), so supplying enough power is controlling factor for this example. Using a higher voltage power supply or a different wire gauge would increase allowable cable length.

Example 2 – Same as above, but there are 4 MicroCATs powered from same power supply.

$$V - IR \geq 8.5 \text{ volts} \quad 12 \text{ volts} - (0.50 \text{ Amps} * 4 \text{ MicroCATs}) * (0.0107 \text{ ohms/foot} * 2 * \text{cable length}) \geq 8.5 \text{ volts}$$

$$3.5 \text{ volts} \geq (0.50 \text{ Amps} * 4 \text{ MicroCATs}) * (0.0107 \text{ ohms/foot} * 2 * \text{cable length})$$

Cable length $\leq 81 \text{ ft} = 25 \text{ meters}$ (to MicroCAT *furthest* from power source)

Timeout Description

The MicroCAT has a timeout algorithm. If the MicroCAT does not receive a command or sample data for 2 minutes, it powers down its communication circuits. This places the MicroCAT in quiescent (sleep) state, drawing minimal current. **To re-establish control (wake up), select *Connect* in Seaterm232's Communications menu or press the Enter key.**

Command Descriptions

This section describes commands and provides sample outputs. Entries made with the commands are permanently stored in the MicroCAT and remain in effect until you change them. See *Appendix III: Command Summary* for a summarized command list.

When entering commands:

- Input commands to the MicroCAT in upper or lower case letters and register commands by pressing the Enter key. Note that commands are shown with a mix of upper and lower case for ease in reading (for example, **InitLogging**), but do not need to be entered that way.
- The MicroCAT sends an error message if an invalid command is entered.
- If a new command is not received within 2 minutes after the completion of a command, the MicroCAT returns to the quiescent (sleep) state.
- If in quiescent (sleep) state, re-establish communications by selecting *Connect* in Seaterm232's Communications menu or pressing the Enter key.
- If the MicroCAT is transmitting data and you want to stop it, press the Esc key or type ^C. Then press the Enter key. Alternatively, select *Abort* in Seaterm232's Command menu.
- The MicroCAT responds only to **GetCD**, **GetSD**, **GetCC**, **GetEC**, **GetHD**, **DS**, **DC**, **TS**, **TSH**, **SL**, **SLT**, **QS**, and **Stop** while sampling (**Start** has been sent). If you wake the MicroCAT while it is sampling autonomously (for example, to send **DS** to check on progress), it temporarily stops sampling. Autonomous sampling resumes when it goes back to sleep (either by sending **QS** or after the 2-minute timeout).
- For consistency with user systems set up for older firmware (< 3.0), the following commands were re-introduced with firmware 3.0j:
 - **Interval=** (equivalent to **SampleInterval=** in current firmware)
 - **Go** (equivalent to **Start** in current firmware)
 - **NCycles=** (no equivalent command in current firmware; this parameter is always set internally to 4. MicroCAT now accepts this command, but does not change any settings or internal calculations.)

Status Commands

Note:

GetCD output does not include calibration coefficients. To display calibration coefficients, use the **GetCC** command.

Note:

The 37-SI and 37-SIP use the same firmware. The internal pump is applicable to the 37-SIP only.

GetCD

Get and display configuration data, which includes parameters related to MicroCAT setup. Most of these parameters can be user-input/modified. List below includes, where applicable, command used to modify parameter:

- Device type, Serial number
- Pressure sensor installed?
- Reference pressure to use in calculations if no pressure sensor installed (only appears if pressure sensor not installed)
 - [**ReferencePressure=**]
- Pump installed? Always no for 37-SI
- Minimum conductivity frequency for pump turn-on; not applicable for 37-SI
- Sampling mode [**SampleMode=**]
- Output data format [**OutputFormat=**]
- Output salinity with each sample [**OutputSal=**]?
 - [**OutputSV=**]?
 - [**OutputDepth=**]?
 - [**Latitude=**]
- Output local density with each sample [**OutputDensity=**]?
 - [**OutputTime=**]?
 - [**SampleInterval=**]
- Interval between samples for continuous sampling [**SampleInterval=**]
- Start sampling when power turned on? [**AutoRun=**]
- Store data in memory [**StoreData=**]?
 - [**StoreData=**]

Example: (user input in bold, command used to modify parameter in parentheses).

GETCD

```

<ConfigurationData DeviceType = 'SBE37SI-RS232' SerialNumber = '037006017'>
  <PressureInstalled>yes</PressureInstalled>           (inclusion of pressure sensor set at factory)
  <PumpInstalled>no</PumpInstalled>                     [only valid setting for 37-SI]
  <MinCondFreq>3000.0</MinCondFreq>                    [only applicable for 37-SIP]
  <SampleMode>interval sample</SampleMode>             [SampleMode=]
  <SampleDataFormat>raw Decimal</SampleDataFormat>     [OutputFormat=]
  <OutputSalinity>no</OutputSalinity>                   [OutputSal=]
  <OutputSV>no</OutputSV>                               [OutputSV=]
  <OutputDepth>yes</OutputDepth>                       [OutputDepth=]
  <Latitude>30.0</Latitude>                             [Latitude=]
  <OutputDensity>no</OutputDensity>                    [OutputDensity=]
  <OutputTime>yes</OutputTime>                          [OutputTime=]
  <SampleInterval>15</SampleInterval>                  [SampleInterval=]
  <AutoRun>no</AutoRun>                                [AutoRun=]
  <StoreData>yes</StoreData>                            [StoreData=]
</ConfigurationData>

```

Status Commands *(continued)*

GetSD

Get and display status data, which contains data that changes while deployed.

List below includes, where applicable, command used to modify parameter:

- Device type, Serial number
- Date and time [**DateTime=**] in ISO8601-2000 extended format (yyyy – mm-ddThh:mm:ss)
- Number of recorded events in event counter [reset with **ResetEC**]
- Voltages - external power supply voltage and back-up lithium battery voltage
- Memory – [reset with **InitLogging**]
 - Number of bytes in memory
 - Number of samples in memory
 - Number of additional samples that can be placed in memory
 - Length (number of bytes) of each sample
- Logging status – yes or no, to indicate whether it is currently logging data

Example: (user input in bold, command used to modify parameter in parentheses)

getsd

```

<StatusData DeviceType = 'SBE37SI-RS232' SerialNumber = '03706017'>
  <DateTime>2012-10-20T00:48:32</DateTime>
  <EventSummary numEvents = '0' />
  <Power>
    <vMain> 7.41</vMain>
    <vLith> 3.16</vLith>
  </Power>
  <MemorySummary>
    <Bytes>0</Bytes>
    <Samples>0</Samples>
    <SamplesFree>559240</SamplesFree>
    <SampleLength>15</SampleLength>
  </MemorySummary>
  <Logging>no</Logging>
</StatusData>

```

[**DateTime=**]
[can clear with **ResetEC=**]

(external power supply voltage)
(back-up lithium battery power supply voltage)

[can clear with **InitLogging**]
[can clear with **InitLogging**]

Status Commands (*continued*)**Notes:**

- Dates shown are when calibrations were performed.
- If the MicroCAT does not include a pressure sensor, the user-input reference pressure (**ReferencePressure=**) appears at the end of the conductivity calibration coefficients.

GetCC

Get and display calibration coefficients, which are initially factory-set and should agree with Calibration Certificates shipped with MicroCAT.

Example: MicroCAT with a pressure sensor (user input in bold, command used to modify parameter in parentheses)

getcc

```

<CalibrationCoefficients DeviceType = 'SBE37SI-RS232' SerialNumber = '03706017'>
  <Calibration format = 'TEMP1' id = 'Temperature'>
    <SerialNum>03706017</SerialNum>
    <CalDate>04-Aug-12</CalDate> [TCalDate=]
    <A0>6.947802e-05</A0> [TA0=]
    <A1>2.615233e-04</A1> [TA1=]
    <A2>-1.265233e-06</A2> [TA2=]
    <A3>1.310479e-07</A3> [TA3=]
  </Calibration>
  <Calibration format = 'WBCOND0' id = 'Conductivity'>
    <SerialNum>03706017</SerialNum>
    <CalDate>04-Aug-12</CalDate> [CCalDate=]
    <G>-1.009121e+00</G> [CG=]
    <H>1.410162e-01</H> [CH=]
    <I>-2.093167e-04</I> [CI=]
    <J>3.637053e-05</J> [CJ=]
    <PCOR>-9.570000e-08</PCOR> [CTCor=]
    <TCOR>3.250000e-06</TCOR> [CPCor=]
    <WBOTC>1.954800e-05</WBOTC> [CWBOTC=]
  </Calibration>
  <Calibration format = 'STRAIN0' id = 'Pressure'>
    <SerialNum>2478619</SerialNum>
    <CalDate>28-Jul-12</CalDate> [PCalDate=]
    <PA0>1.729067e+00</PA0> [PA0=]
    <PA1>1.415754e-01</PA1> [PA1=]
    <PA2>1.246912e-08</PA2> [PA2=]
    <PTCA0>2.243971e+00</PTCA0> [PTCA0=]
    <PTCA1>1.055267e+00</PTCA1> [PTCA1=]
    <PTCA2>-2.276308e-02</PTCA2> [PTCA2=]
    <PTCB0>1.003849e+02</PTCB0> [PTCB0=]
    <PTCB1>1.014510e-02</PTCB1> [PTCB1=]
    <PTCB2>-2.057110e-04</PTCB2> [PTCB2=]
    <PTEMPA0>5.669780e+01</PTEMPA0> [PTempA0=]
    <PTEMPA1>-5.474043e-02</PTEMPA1> [PTempA1=]
    <PTEMPA2>1.267908e-05</PTEMPA2> [PTempA2=]
    <POFFSET>0.000000e+00</POFFSET> [POffset= (decibars)]
    <PRANGE>0.000000e+00</PRANGE> [PRange= (psi)]
  </Calibration>
</CalibrationCoefficients>

```

Status Commands (*continued*)

GetEC

Get and display event counter data, which can help to identify root cause of a malfunction. Event counter records number of occurrences of common timeouts, power-on resets, etc. Can be cleared with **ResetEC**. Possible events that may be logged include:

- WDT reset – unexpected reset
- PON reset - power cycled on (each time power is applied)
- ErrorADC12TimeOut – response delayed from A/D converter that measures external power and back-up lithium battery power
- ErrorUART0TimeOut – timeout for transmitter to finish transmitting previous character via RS-232
- ErrorAD7714TimeOut – response delayed from temperature and pressure A/D converter
- ErrorInvWakeUpFlag – unexpected wakeup
- ErrorFLASHTimeOut – problem with writing data to FLASH memory
- Alarm long - time to take next sample is too far in future
- Alarm short - woke up MicroCAT to send a command while logging, and missed taking a sample
- LoggingRestartNoAlarm – no sample taken for 8 hours while logging, restart logging

Example: (user input in bold, command used to modify parameter in parentheses)

getec

```
<EventCounters DeviceType = 'SBE37SI-RS232' SerialNumber = '03706017'>
  <EventSummary numEvents = '0' /> [can clear with ResetEC]
</EventCounters>
```

ResetEC

Delete all events in event counter (number of events displays in **GetSD** response, and event details display in **GetEC** response).

Status Commands (*continued*)

GetHD

Get and display hardware data, which is fixed data describing MicroCAT:

- Device type, Serial number
- Manufacturer
- Firmware version
- Firmware date
- PCB assembly number
- Manufacture date
- Sensor types and serial numbers

Example: (user input in bold, command used to modify parameter in parentheses)

gethd

```

<HardwareData DeviceType = 'SBE37SI-RS232' SerialNumber = '03706017'>
  <Manufacturer>Sea-Bird Electronics, Inc.</Manufacturer>
  <FirmwareVersion>3.1</FirmwareVersion>
  <FirmwareDate>20 Jln 2012 08:30</FirmwareDate>
  <PCBAssembly>41609A</PCBAssembly>
  <PCBAssembly>41610A</PCBAssembly>
  <PCBAssembly>41611B</PCBAssembly>
  <MfgDate>20 Jan 2012</MfgDate>
  <FirmwareLoader>SBE 37 FirmwareLoader V 1.0</FirmwareLoader>
  <InternalSensors>
    <Sensor id = 'Temperature'>
      <type>temperature-1</type>
      <SerialNumber>03706017</SerialNumber>
    </Sensor>
    <Sensor id = 'Conductivity'>
      <type>conductivity-1</type>
      <SerialNumber>03706017</SerialNumber>
    </Sensor>
    <Sensor id = 'Pressure'>
      <type>strain-0</type>
      <SerialNumber>2478619</SerialNumber>
    </Sensor>
  </InternalSensors>
</HardwareData>

```

Status Commands (*continued*)**Note:**

The **DS** response contains similar information as the combined responses from **GetSD** and **GetCD**, but in a different format.

DS

Display operating status and setup parameters.

List below includes, where applicable, command used to modify parameter.

- Firmware version, serial number, date and time [**DateTime=**]
- External power voltage and back-up internal lithium battery voltage
- Number of samples and available sample space in memory
- Logging status (logging not started, logging data, not logging, or unknown)
- Interval between samples for autonomous sampling [**SampleInterval=**]
- Output data format [**OutputFormat=**]
- Output salinity with each sample [**OutputSal=**]? Only displays if set to yes
- Output sound velocity with each sample [**OutputSV=**]? Only displays if set to yes
- Output local density with each sample [**OutputDensity=**]? Only displays if set to yes
- Output depth with each sample [**OutputDepth=**]? Latitude for depth calculation [**Latitude=**]. Only displays if **OutputDepth=** set to yes
- Output time with each sample [**OutputTime=**]? Only displays if set to yes
- Sampling mode [**SampleMode=**]
- Start sampling when power turned on [**AutoRun=**]?
- Store data in memory [**StoreData=**]?
- Pump installed? Always no for 37-SI
- Reference pressure to use in calculations if no pressure sensor installed (only appears if pressure sensor not installed) [**ReferencePressure=**]

Note:

The 37-SI and 37-SIP use the same firmware. The internal pump is applicable to the 37-SIP only.

Example: (user input in bold, command used to modify parameter in parentheses).

DS

```
SBE37SI-RS232 3.1 SERIAL NO. 6017 20 Oct 2012 00:48:50
vMain = 7.41, vLith = 3.16
samplenum = 0, free = 559240
status = not logging
sample interval = 15 seconds
data format = converted engineering
output salinity
output sound velocity
output density
output depth, latitude = 30.0
output time
sample mode = interval sample
auto run = no
store data = yes
pump installed = no
```

[**DateTime=**][can clear with **InitLogging**][**SampleInterval=**][**OutputFormat=**][**OutputSal=**][**OutputSV=**][**OutputDensity=**][**OutputDepth=, Latitude=**][**OutputTime=**][**SampleMode=**][**AutoRun=**][**StoreData=**]

[only valid setting for 37-SI]

Status Commands *(continued)*

Notes:

- The **DC** and **GetCC** responses contain the same information, but in different formats.
- Dates shown are when calibrations were performed.

DC

Display calibration coefficients, which are initially factory-set and should agree with Calibration Certificates shipped with MicroCAT.

Example: MicroCAT with a pressure sensor (user input in bold, command used to modify parameter in parentheses).

```

DC
SBE37SI-RS232 V 3.1 6017
temperature: 04-aug-12
TA0 = 6.947802e-05
TA1 = 2.615233e-04
TA2 = -1.265233e-06
TA3 = 1.310479e-07
conductivity: 04-aug-12
G = -1.036689e+00
H = 1.444342e-01
I = -3.112137e-04
J = 3.005941e-05
CPCOR = -9.570001e-08
CTCOR = 3.250000e-06
WBOTC = 1.968100e-05
pressure S/N 2478619, range = 2901 psia, 03-aug-12
PA0 = 0.000000e+00
PA1 = 0.000000e+00
PA2 = 0.000000e+00
PTCA0 = 0.000000e+00
PTCA1 = 0.000000e+00
PTCA2 = 0.000000e+00
PTCB0 = 0.000000e+00
PTCB1 = 0.000000e+00
PTCB2 = 0.000000e+00
PTEMPA0 = 0.000000e+00
PTEMPA1 = 0.000000e+00
PTEMPA2 = 0.000000e+00
POFFSET = 0.000000e+00
    
```

[TCalDate=]
 [TA0=]
 [TA1=]
 [TA2=]
 [TA3=]
 [CCalDate=]
 [CG=]
 [CH=]
 [CI=]
 [CJ=]
 [CPCor=]
 [CTCor=]
 [CWBOTC=]
 [PRange= (psi), PCalDate=]
 [PA0=]
 [PA1=]
 [PA2=]
 [PTCA0=]
 [PTCA1=]
 [PTCA2=]
 [PTCB0=]
 [PTCB1=]
 [PTCB2=]
 [PTempA0=]
 [PTempA1=]
 [PTempA2=]
 [POffset= (decibars)]

General Setup Commands

DateTime=
mmddyyhhmmss Set real-time clock month, day, year, hour, minute, second.

Example: Set current date and time to 10 September 2012 12:00:00 (user input in bold).
datetime=09102012120000

Notes:

- The MicroCAT baud rate (set with **BaudRate=**) must be the same as Seaterm232's baud rate (set in the Communications menu).
- **BaudRate=** must be sent twice. After the first entry, the MicroCAT changes to the new baud, and then waits for the command to be sent again at the new baud (In Seaterm232's Communications menu, select *Configure*. In the dialog box, select the new baud rate and click OK. Then retype the command.). This prevents you from accidentally changing to a baud that is not supported by your computer. If it does not receive the command again at the new baud, it reverts to the previous baud rate.

BaudRate=x x= baud rate (600, 1200, 2400, 4800, 9600, 19200, 38400, 57600, or 115200). Default 9600. Check capability of your computer and terminal program before increasing baud; high baud requires a short cable and good PC serial port with accurate clock. **Command must be sent twice to change rate.** Length of cable that MicroCAT can drive is dependent on baud. See *Baud Rate, Cable Length, Power, and Data Transmission Rate*.

OutputExecutedTag=x x=**Y**: Display XML Executing and Executed tags. Executed tag displays at end of each command response; Executing tag displays one or more times if MicroCAT response to command requires additional time.
x=**N**: Do not.

Example: Set MicroCAT to output Executed and Executing tags (user input in bold).
outputexecutedtag=y
<Executed/>**getcd**
. . . (GetCD response)
<Executed/>
(Note: <Executed/> tag at end of command response takes place of S> prompt.)

ReferencePressure=x x = reference pressure (gauge) in decibars. MicroCAT without installed pressure sensor uses this reference pressure in conductivity (and optional salinity, sound velocity, depth, and density) calculations. Entry ignored if MicroCAT includes pressure sensor.

Note:

The MicroCAT automatically enters quiescent state after 2 minutes without receiving a command. This timeout algorithm is designed to conserve power if the user does not send **QS** to put the MicroCAT to sleep.

QS Quit session and place MicroCAT in quiescent (sleep) state. Data logging and memory retention are not affected.

Note:

If the FLASH memory is filled to capacity, sampling continues, but excess data is not saved in memory (i.e., the MicroCAT does not overwrite data in memory).

Memory Setup Commands**StoreData=x**

x=Y (default): Store data to FLASH memory when sampling.

x=N: Do not.

Note:

Do not send InitLogging or SampleNumber=0 until all data has been uploaded. These commands do not delete the data; they just reset the data pointer. **If you accidentally send one of these commands before uploading**, recover the data as follows:

1. Set **SampleNumber=x**, where **x** is your estimate of number of samples in memory.
2. Upload data. If **x** is more than actual number of samples in memory, data for non-existent samples will be bad, random data. Review uploaded data file carefully and delete any bad data.
3. If desired, increase **x** and upload data again, to see if there is additional valid data in memory.

InitLogging

Initialize logging – after all previous data has been uploaded, initialize logging before starting to sample again to make entire memory available for recording. **InitLogging** sets sample number (**SampleNumber=**) to 0 (sampling will start with sample 1). If not set to 0, data will be stored after last recorded sample. **Do not send InitLogging until all existing data has been uploaded.**

SampleNumber=

x = sample number for last sample in memory. **SampleNumber=0** is equivalent to **InitLogging**. **Do not send SampleNumber=0 until all existing data has been uploaded.**

Output Format Setup Commands

Notes:

- See *Data Formats* after the command descriptions for complete details.
- Binary data does not output on the screen. Use Seaterm232's Capture menu to capture the data to a file before beginning sampling, and then process the data with a utility.
- The MicroCAT always stores the sample time in memory, regardless of the setting for **OutputTime=**.
- The MicroCAT does not *store* salinity, sound velocity, density, and/or depth in memory if the respective parameters are enabled for output. It calculates and outputs the values real-time or as data is uploaded; therefore, outputting these parameters has no effect on the number of samples that can be stored in memory.
- Salinity, sound velocity, density, and depth can also be calculated in SBE Data Processing, from data uploaded from the MicroCAT's memory.

OutputFormat=x	<p>x=0: output raw decimal data.</p> <p>x=1 (default): output converted decimal data.</p> <p>x=2: output converted decimal data in XML.</p> <p>x=3: output converted binary data.</p> <p>x=4: output converted decimal data, alternate format.</p> <p>x=5: output converted decimal data, BSH format.</p>
OutputTime=x	<p>x=Y: output date and time. Only applies if OutputFormat=0, 1, 2, 4, or 5.</p> <p>x=N: do not.</p>
OutputSal=x	<p>x=Y: calculate and output salinity (psu). Only applies if OutputFormat=1, 2, 4, or 5.</p> <p>x=N: do not.</p>
OutputSV=x	<p>x=Y: calculate and output sound velocity (m/sec), using Chen and Millero formula (UNESCO Technical Papers in Marine Science #44). Only applies if OutputFormat=1, 2, 4, or 5.</p> <p>x=N: do not.</p>
OutputDensity=x	<p>x=Y: calculate and output local density (kg/m^3), based on salinity, temperature, and pressure. Only applies if OutputFormat=1, 2, 4, or 5. Note: Local density = $\text{Sigma}(s,t,p) - 1000$</p> <p>x=N: do not.</p>
OutputDepth=x	<p>x=Y: calculate and output depth (meters), using Latitude in calculation. Only applies if OutputFormat=1, 2, 4, or 5.</p> <p>x=N: do not.</p>
Latitude=x	<p>x= latitude (degrees) to use in depth calculation. Only applicable if OutputDepth=Y.</p>

Operating Commands

Operating commands configure the MicroCAT’s response on waking up, and direct it to sample once, at pre-programmed intervals, or continuously.

Note:
Sampling is started by one of the following methods:

- (if **AutoRun=N**) Send **Start**.
- (if **AutoRun=Y**) Apply power.

SampleMode=x **x=1:** When commanded to sample, take a single sample.
x=2: When commanded to sample, sample at intervals defined by **SampleInterval=**.
x=3: When commanded to sample, sample continuously.

SampleInterval=x or Interval=x **x=** interval (6 - 21600 seconds) between samples when **SampleMode=2**.

Note:
If **AutoRun=Y** and **SampleMode=2** or **3**, a simple 3-wire system (Power, Ground, Transmit) may be used for deployment, since it is not necessary to command the MicroCAT to take each sample. Note that the MicroCAT does not respond to any commands in this configuration, so initial setup must be performed with all 4 wires in place.

AutoRun=x **x=Y:** When power is applied, wake up and automatically begin to sample as defined by **SampleMode=**.
x=N: When power is applied, wake up but do **not** automatically begin to sample, unless **Start** has been sent and **Stop** has not been sent.

Start or Go Start sampling, as defined by **SampleMode=**. Applicable if:

- **AutoRun=N**, or
- **AutoRun=Y** and you previously sent **Stop** to stop sampling.

Note:
You may need to send **Stop** several times to get the MicroCAT to respond. This is most likely to occur if sampling continuously or with a small **SampleInterval**.

Stop Stop sampling. Press any key before entering **Stop**. **Stop** must be sent before uploading data from memory.

The table below summarizes the interaction of the operating commands:

SampleMode=	AutoRun=	Effect
1	N	Wake up when power is applied and <i>Connect</i> (Communications menu) is selected or any key is pressed while asleep, and wait for command. When Start is sent, take 1 sample and go to sleep. Take another sample each time a pulse is received (press any key) or power is cycled.
2	N	Wake up when power is applied and <i>Connect</i> (Communications menu) is selected or any key is pressed while asleep, and wait for command. When Start is sent, sample at intervals defined by SampleInterval= . MicroCAT goes to sleep between samples. To stop sampling: press any key, type Stop , and press Enter key. Note: If power is removed before Stop is sent, sampling restarts when power is reapplied.
3	N	Wake up when power is applied and <i>Connect</i> (Communications menu) is selected or any key is pressed while asleep, and wait for command. When Start is sent, sample continuously, at fastest possible rate. To stop sampling: press any key, type Stop , and press Enter key. Note: If power is removed before Stop is sent, sampling restarts when power is reapplied.
1	Y	Wake up when power is applied, take 1 sample, and go to sleep. Take another sample each time a pulse is received (press any key) or power is cycled. To wake up: press any key, type Stop , and press Enter key.
2	Y	Wake up when power is applied and sample at rate specified by SampleInterval= until power is removed. MicroCAT goes to sleep between samples. To stop sampling: press any key, type Stop , and press Enter key. Note: If power is removed before Stop is sent, sampling restarts when power is reapplied.
3	Y	Wake up when power is applied and sample continuously, at fastest possible rate, until power is removed. MicroCAT does not go to sleep between samples. To stop sampling: press any key, type Stop , and press Enter key. Note: If power is removed before Stop is sent, sampling restarts when power is reapplied.

Polled Sampling Commands

Note:

The MicroCAT has a buffer that stores the most recent data samples. Unlike data in the FLASH memory, data in the buffer is erased upon removal of power.

These commands are used to request 1 or more samples from the MicroCAT. The MicroCAT stores data for the most recent sample in its buffer. Unless noted otherwise, the MicroCAT does not store the data in FLASH memory.

TS	Take sample, store data in buffer, output data.
TSH	Take sample, store data in buffer (do not output data).
TSS	Take new sample, store data in buffer and in FLASH memory , and output data. Note: MicroCAT ignores this command if sampling data (Start has been sent).
TSN:x	Take x samples and output data. To interrupt this sampling, press Esc key. Note: MicroCAT ignores this command if sampling data (Start has been sent).
SL	Output last sample stored in buffer.
SLT	Output last sample stored in buffer. Then take new sample and store data in buffer (do not output data from new sample).

Notes:

- Use **Seaterm232's Upload menu to upload data that will be processed by SBE Data Processing**. Manually entering a data upload command does not produce data with the required header information for processing by our software. These commands are included here for reference for users who are writing their own software.
- **If not using the Upload menu** - To save data to a file, click Capture before entering a data upload command.
- See *Data Formats*.

Data Upload Commands

Stop sampling (send **Stop** command) before uploading data.

GetSamples:b,e	Upload data from scan b to scan e , in format defined by OutputFormat= . First sample is number 1. As data is uploaded, screen first displays start time = start sample number = These are start time and starting sample number for last set of logged data; can be useful in determining what data to review.
DDb,e	Upload data from scan b to scan e , in alternate converted decimal form (OutputFormat=4) (regardless of setting for OutputFormat=). First sample is number 1. As data is uploaded, screen first displays start time = start sample number =. These are start time and starting sample number for last set of logged data; can be useful in determining what data to review.

Example: Upload samples 1 to 200 to a file (user input in bold).

(Click Capture menu and enter desired filename in dialog box)

GETSAMPLES : 1 , 200

or

DD1 , 200

Calibration Coefficients Commands

Calibration coefficients are initially factory-set and should agree with Calibration Certificates shipped with the MicroCAT.

Note:

F = floating point number
S = string with no spaces

Temperature

TCalDate=S	S=Temperature calibration date
TA0=F	F=Temperature A0
TA1=F	F=Temperature A1
TA2=F	F=Temperature A2
TA3=F	F=Temperature A3

Conductivity

CCalDate=S	S=Conductivity calibration date
CG=F	F=Conductivity G
CH=F	F=Conductivity H
CI=F	F=Conductivity I
CJ=F	F=Conductivity J
WBOTC=F	F=Conductivity wbotc
CTCor=F	F=Conductivity ctcor
CPCor=F	F=Conductivity cpcor

Pressure

PCalDate=S	S=Pressure calibration date
PA0=F	F=Pressure A0
PA1=F	F=Pressure A1
PA2=F	F=Pressure A2
PTCA0=F	F=Pressure ptca0
PTCA1=F	F=Pressure ptca1
PTCA2=F	F=Pressure ptca2
PTCB0=F	F=Pressure ptcb0
PTCB1=F	F=Pressure ptcb1
PTCB2=F	F=Pressure ptcb2
PTempA0=F	F=Pressure temperature a0
PTempA1=F	F=Pressure temperature a1
PTempA2=F	F=Pressure temperature a2
POffset=F	F=Pressure offset (decibars)

Data Formats

Notes:

- Time is the time at the **start** of the sample.
- The MicroCAT's pressure sensor is an absolute sensor, so its **raw** output includes the effect of atmospheric pressure (14.7 psi). As shown on the Calibration Sheet, Sea-Bird's calibration (and resulting calibration coefficients) is in terms of psia. However, when outputting pressure in **decibars**, the MicroCAT outputs pressure relative to the ocean surface (i.e., at the surface the output pressure is 0 decibars). The MicroCAT uses the following equation to convert psia to decibars:

$$\text{pressure (db)} = [\text{pressure (psia)} - 14.7] * 0.689476$$

Each scan ends with a carriage return <CR> and line feed <LF>.

- **OutputFormat=0**: raw decimal data, for diagnostic use at Sea-Bird
 ttttt, cccc.ccc, pppppp, vvvv, dd mmm yyyy, hh:mm:ss

where

ttttt = temperature A/D counts.

cccc.ccc = conductivity frequency (Hz).

pppppp = pressure sensor pressure A/D counts; sent only if pressure sensor installed.

vvvv = pressure sensor pressure temperature compensation A/D counts; sent only if pressure sensor installed.

dd mmm yyyy = day, month, year; sent only if **OutputTime=Y**.

hh:mm:ss = hour, minute, second; sent only if **OutputTime=Y**.

Note that depth, density, salinity, and sound velocity are not sent, regardless of the setting for those parameters. All data is separated with a comma and a space.

Example: Sample data output when pressure sensor is installed, **OutputFormat=0**, **OutputDepth=Y**, **OutputSal=Y**, **OutputSV=Y**, **OutputDensity=Y**, and **OutputTime=Y**:

524276, 2886.656, 785053, 2706, 20 Oct 2012, 09:01:34
 (temperature, conductivity, pressure sensor pressure, pressure sensor temperature compensation, date, time)

- **OutputFormat=1** (default): converted decimal data
 tttt.tttt,ccc.ccccc,ppppp.ppp,dddd.ddd,ssss.ssss,vvvv.vvv,rrr.rrrr,
 dd mmm yyyy, hh:mm:ss

where

tttt.tttt = temperature (°C, ITS-90).

ccc.ccccc = conductivity (S/m).

ppppp.ppp = pressure (decibars); sent only if pressure sensor installed.

dddd.ddd = depth (meters); sent only if **OutputDepth=Y**.

ssss.ssss = salinity (psu); sent only if **OutputSal=Y**.

vvvv.vvv = sound velocity (meters/second); sent only if **OutputSV=Y**.

rrr.rrrr = local density (kg/m³); sent only if **OutputDensity=Y**.

dd mmm yyyy = day, month, year; sent only if **OutputTime=Y**.

hh:mm:ss = hour, minute, second; sent only if **OutputTime=Y**.

Leading zeros are suppressed, except for one zero to the left of the decimal point. All data is separated with a comma, date and time are also preceded by a space.

Example: Sample data output when pressure sensor is installed, **OutputFormat=1**, **OutputDepth=Y**, **OutputSal=Y**, **OutputSV=Y**, **OutputDensity=Y**, **OutputTime=Y**:

8.5796, 0.15269, 531.316, 527.021, 1.1348,1451.478, 3.2486, 20 Oct 2012, 09:01:44
 (temperature, conductivity, pressure, depth, salinity, sound velocity, local density, date, time)

Note:

For ease in reading, the data structure is shown with each XML tag on a separate line. However, there are no carriage returns or line feeds between tags (see example below).

- **OutputFormat=2:** converted decimal data in XML

```
<?xml version="1.0"?>
<datapacket>
<hdr>
<mfg>Sea-Bird</mfg>
<model>37si</model>
<sn>nnnnnnnn</sn>
</hdr>
<data>
<t1>t1.t1</t1>
<c1>cc.cccc</c1>
<p1>pppp.ppp </p1>
<dm>ddd.d</dm>
<sal>sss.ssss</sal>
<sv>vvv.vv</sv>
<sr>rrr.rrr</sr>
<dt>yyyy-mm-ddThh:mm:ss</dt>
</data>
</datapacket>
```

where

nnnnnnnn = MicroCAT serial number.

t1.t1 = temperature (°C, ITS-90).

cc.cccc = conductivity (S/m).

pppp.ppp = pressure (decibars); sent only if pressure sensor installed.

ddd.d = depth (meters); sent only if **OutputDepth=Y**.

sss.ssss = salinity (psu); sent only if **OutputSal=Y**.

vvv.vv = sound velocity (meters/second); sent only if **OutputSV=Y**.

rrr.rrr = local density (kg/m³); sent only if **OutputDensity=Y**.

yyyy-mm-ddThh:mm:ss = year, month, day, hour, minute, second;
sent only if **OutputTime=Y**.

Leading zeros are suppressed, except for one zero to the left of the decimal point.

Example: Sample data output when pressure sensor is installed, **OutputFormat=2**, **OutputDepth=Y**, **OutputSal=Y**, **OutputSV=Y**, **OutputDensity=Y**, and **OutputTime=Y**:

```
<?xml version="1.0"?><datapacket><hdr><mfg>Sea-Bird</mfg><model>37SI</model>
<sn>03709999</sn></hdr><data><t1> 8.5796</t1><c1> 0.15269</c1><p1> 531.316</p1>
<dm> 527.021</dm><sal> 1.1348</sal><sv>1451.478</sv><sr> 3.2486</sr>
<dt>2012-10-20T09:01:44</dt></data></datapacket> CRLF
(temperature, conductivity, pressure, depth, salinity, sound velocity, local density, date and time)
```

- **OutputFormat=3:** converted data in binary.

tttccccppph

where:

ttt = temperature *100000.

cccc = conductivity *100000.

pppp = pressure *100000 (sent only if pressure sensor installed).

h=1 byte checksum, sum of all bytes including checksum modulo 256 is 0.

ttt, cccc, and pppp are each a 4 byte long integer stored *little endian*.

- **OutputFormat=4:** converted decimal data, *alternate*
ttt.tttt,cc.ccccc, pppp.ppp, dddd.ddd, sss.ssss, vvvv.vvv, rrr.rrrr,
dd mmm yyyy, hh:mm:ss

Note:

This format is identical to the format from an SBE 37-SI with **firmware < 3.0** and **Format=1**. It is provided for compatibility with systems programmed for those older instruments.

where

ttt.tttt = temperature (°C, ITS-90).

cc.ccccc = conductivity (S/m).

pppp.ppp = pressure (decibars); sent only if pressure sensor installed.

dddd.ddd = depth (meters); sent only if **OutputDepth=Y**.

sss.ssss = salinity (psu); sent only if **OutputSal=Y**.

vvvv.vvv = sound velocity (meters/second); sent only if **OutputSV=Y**.

rrr.rrrr = local density (kg/m³); sent only if **OutputDensity=Y**.

dd mmm yyyy = day, month, year; sent only if **OutputTime=Y**.

hh:mm:ss = hour, minute, second; sent only if **OutputTime=Y**.

Leading zeros are suppressed, except for one zero to the left of the decimal point. There is a comma but no space between temperature and conductivity. All other data is separated with a comma and a space.

Example: Sample data output when pressure sensor is installed, **OutputFormat=4, OutputDepth=Y, OutputSal=Y, OutputSV=Y, OutputDensity=Y, OutputTime=Y:**

8.5796, 0.15269, 531.316, 527.021, 1.1348, 1451.478, 3.2486, 20 Oct 2012,
09:01:44

(temperature, conductivity, pressure, depth, salinity, sound velocity, local density, date, time)

- **OutputFormat=5:** converted decimal data, *BSH*
ttt.tttt,cc.ccccc, pppp.ppp, dddd.ddd, sss.ssss, vvvv.vvv, rrr.rrrr,
mm-dd-yyyy, hh:mm:ss

Note:

This format is identical to the format from an SBE 37-SI with **firmware < 3.0** and **Format=2**. It is provided for compatibility with systems programmed for those older instruments.

where

ttt.tttt = temperature (°C, ITS-90).

cc.ccccc = conductivity (S/m).

pppp.ppp = pressure (decibars); sent only if pressure sensor installed.

dddd.ddd = depth (meters); sent only if **OutputDepth=Y**.

sss.ssss = salinity (psu); sent only if **OutputSal=Y**.

vvvv.vvv = sound velocity (meters/second); sent only if **OutputSV=Y**.

rrr.rrrr = local density (kg/m³); sent only if **OutputDensity=Y**.

mm-dd-yyyy = month, day, year; sent only if **OutputTime=Y**.

hh:mm:ss = hour, minute, second; sent only if **OutputTime=Y**.

Leading zeros are suppressed, except for one zero to the left of the decimal point. There is a comma but no space between temperature and conductivity. All other data is separated with a comma and a space.

Example: Sample data output when pressure sensor is installed, **OutputFormat=5, OutputDepth=Y, OutputSal=Y, OutputSV=Y, OutputDensity=Y, OutputTime=Y:**

8.5796, 0.15269, 531.316, 527.021, 1.1348, 1451.478, 3.2486, 10-20-2012, 09:01:44
(temperature, conductivity, pressure, depth, salinity, sound velocity, local density, date, time)

Setup for Deployment

Program the MicroCAT for the intended deployment (see *Section 3: Preparing MicroCAT for Deployment* for connection information; see information above on commands and sampling modes):

1. Set the date and time (**DateTime=**), and establish setup parameters.
2. Ensure all data has been uploaded, and then send **InitLogging** to make the entire memory available for recording.
3. Establish operating command parameters. These parameters configure the MicroCAT's response upon waking up, and direct the MicroCAT to sample data once, at pre-programmed intervals, or continuously.

Deployment

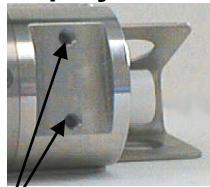

Tapped holes for mounting clamp

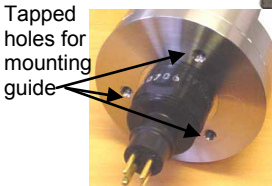

Tapped holes for mounting guide



Sea-Bird mounting clamp and guide or flat surface mounting brackets

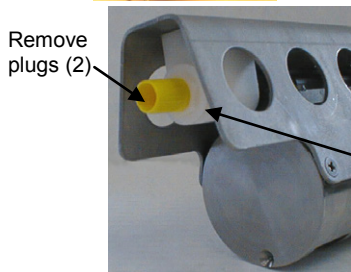

Remove plugs (2)

Anti-foulant device cups (2)

CAUTIONS:

- Do not use **WD-40** or other petroleum-based lubricants, as they will damage the connectors.
- For wet-pluggable MCBH connectors: **Silicone lubricants in a spray can** may contain ketones, esters, ethers, alcohols, or glycols in their propellant. **Do not use these sprays, as they will damage the connector.**

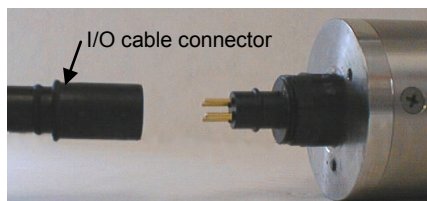

I/O cable connector

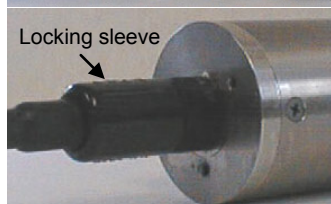

Locking sleeve

The MicroCAT can be mounted with customer-supplied hardware or can be ordered with pre-installed Sea-Bird mounting brackets.

1. Install customer-supplied mounting equipment (if Sea-Bird mounting clamp and guide or brackets are not pre-installed):
 - A. Install a mounting bracket that attaches to the tapped holes in the MicroCAT sensor end cap. Use titanium hardware to attach the mounting bracket to the MicroCAT, and place non-metallic material between the titanium housing and any dissimilar metal in the bracket. **Do not drill any holes in the MicroCAT.**
 - B. Ensure the mounting scheme does not transfer mooring through-tension to the sensor end cap, which could pull off the end cap.
2. New MicroCATs are shipped with AF24173 Anti-Foulant Devices and protective plugs pre-installed.
 - A. Remove the protective plugs, if installed, from the anti-foulant device cups. **The protective plugs must be removed prior to deployment or pressurization.** If the plugs are left in place during deployment, the sensor will not register conductivity. If left in place during pressurization, the cell may be destroyed.
 - B. Verify that the anti-foulant device cups contain AF24173 Anti-Foulant Devices (see *Section 5: Routine Maintenance and Calibration*).
3. Install the I/O cable on the MicroCAT:
 - A. Lightly lubricate the inside of the cable connector with silicone grease (DC-4 or equivalent).
 - B. **XSG Connector** (shown in photos) - Install the cable connector, aligning the raised bump on the side of the connector with the large pin (pin 1 - ground) on the MicroCAT. Remove any trapped air by *burping* or gently squeezing the connector near the top and moving your fingers toward the end cap. **OR** **MCBH Connector** - Install the cable connector, aligning the pins.
 - C. Place the locking sleeve over the connector. Tighten the locking sleeve finger tight only. **Do not overtighten the locking sleeve and do not use a wrench or pliers.**
4. Attach the mounting equipment to the mooring cable or support.
5. Verify that the hardware and external fittings are secure.
6. Connect the MicroCAT to the computer and power (see *Power and Communications Test* in *Section 3: Preparing MicroCAT for Deployment*). If you have not already done so, send **Start** to start sampling.
7. If using Seaterm232 to view real-time data, click the Capture menu before you begin sampling. Enter the desired capture file name in the dialog box, and click Save. Data displayed in Seaterm232 will be saved to the designated .cap file. The .cap file **cannot be processed by Sea-Bird software, as it does not have the required headers and format.**

Recovery

WARNING!

If the MicroCAT stops working while underwater, is unresponsive to commands, or shows other signs of flooding or damage, carefully secure it away from people until you have determined that abnormal internal pressure does not exist or has been relieved. Pressure housings may flood under pressure due to dirty or damaged o-rings, or other failed seals. When a sealed pressure housing floods at great depths and is subsequently raised to the surface, water may be trapped at the pressure at which it entered the housing, presenting a danger if the housing is opened before relieving the internal pressure. Instances of such flooding are rare. However, a housing that floods at 5000 meters depth holds an internal pressure of more than 7000 psia, and has the potential to eject the end cap with lethal force. A housing that floods at 50 meters holds an internal pressure of more than 85 psia; this force could still cause injury.

If you suspect the MicroCAT is flooded, point it in a safe direction away from people, and loosen the bulkhead connector very slowly, at least 1 turn. This opens an o-ring seal under the connector. Look for signs of internal pressure (hissing or water leak). If internal pressure is detected, let it bleed off slowly past the connector o-ring. Then, you can safely remove the end cap.

1. Rinse the conductivity cell with fresh water. (See *Section 5: Routine Maintenance and Calibration* for cell cleaning and storage.)
2. Reinsert the protective plugs in the anti-foulant device cups.

Uploading and Processing Data

*Note: For best performance and compatibility, Sea-Bird recommends that customers set their computer to English language format and the use of a period (.) for the decimal symbol. Some customers have found corrupted data when using the software's **binary upload** capability while set to other languages. To update your computer's language and decimal symbol (instructions are for a Windows 7 operating system):*

1. *In the computer Control Panel window, select Region and Language.*
2. *In the Region and Language window, on the Formats tab, select English in the Format pull down box.*
3. *In the Region and Language window, click the Additional settings . . . button. In the Customize Format window, select the period (.) in the Decimal symbol pull down box, and click OK.*
4. *In the Region and Language window, click OK.*

Follow the procedure below to upload data:

1. Double click on **SeatermV2.exe**. The main screen appears.
2. In the Instruments menu, select *SBE 37 RS232*. **Seaterm232** opens.
3. Seaterm232 tries to automatically connect to the MicroCAT. As it connects, it sends **GetHD** and displays the response. Seaterm232 also fills the Send Commands window with the correct list of commands for your MicroCAT. **If there is no communication:**
 - A. In the Communications menu, select *Configure*. The Serial Port Configuration dialog box appears. Select the Comm port and baud rate for communication, and click OK. Note that the factory-set baud rate is documented on the Configuration Sheet.
 - B. In the Communications menu, select *Connect* (if *Connect* is grayed out, select *Disconnect and reconnect*). Seaterm232 will attempt to connect at the baud specified in Step A, but if unsuccessful will then cycle through all other available baud rates.
 - C. If there is still no communication, check cabling between the computer and MicroCAT.
 - D. If there is still no communication, repeat Step A with a different comm port, and try to connect again.

Note:

Data may be uploaded during deployment or after recovery. If uploading after recovery, connect the I/O cable as described in *Power and Communications Test* in *Section 3: Preparing MicroCAT for Deployment*.

Note:

You may need to send **Stop** several times to get the MicroCAT to respond.

4. If sampling autonomously, command the MicroCAT to stop logging by pressing any key, typing **Stop**, and pressing the Enter key.

5. Display MicroCAT status information by typing **DS** and pressing the Enter key. The display looks like this:

```
SBE37SI-RS232 3.1 SERIAL NO. 6017 20 Oct 2012 00:48:50
vMain = 7.41, vLith = 3.16
samplenum = 6, free = 559234
status = not logging
sample interval = 15 seconds
data format = converted engineering
output time
sample mode = interval sample
auto run = no
store data = yes
pump installed = no
```

Verify that the status is **not logging**.

Note:

BaudRate= must be sent twice. After the first entry, the MicroCAT changes to the new baud, and then waits for the command to be sent again at the new baud (In Seaterm232's Communications menu, select *Configure*. In the dialog box, select the new baud rate and click OK. Then retype the command.). If it does not receive the command again at the new baud, it reverts to the previous baud rate.

6. If desired, increase the MicroCAT's baud rate for data upload.

7. Click the Upload menu to upload stored data. Seaterm232 responds as follows:
 - A. Seaterm232 sends **GetHD** and displays the response, verifying that it is communicating with the 37-SI.
 - B. Seaterm232 sends **OutputExecutedTag=Y**; this setting is required for the upload.
 - C. Seaterm232 sends **GetSD** and displays the response, providing information on the number of samples in memory.
 - D. In the Save As dialog box, enter the desired upload file name and click Save. The upload file has a .XML extension.
 - E. An Upload Data dialog box appears:

Note:
 If binary upload is selected, Seaterm232 uploads the data in binary and then converts it to ASCII text, resulting in a data file that is identical to one uploaded in ASCII text.

Select number of bytes uploaded in each block. Seaterm232 uploads data in blocks, and calculates a checksum at end of each block. If block fails checksum verification, Seaterm232 tries to upload block of data again, cutting block size in half.

Defines data upload type and range:

- All data as a single file – All data is uploaded into 1 file.
- By scan number range – Enter beginning scan (sample) number and total number of scans. All data within range is uploaded into 1 file.

To change upload file name selected in Step D above, click Browse to navigate to desired upload file path and name. Upload file has a .xml extension. After Seaterm232 uploads data into .xml data file, it creates .hex data file and .xmlcon configuration file that are compatible with SBE Data Processing. These files are placed in same directory as .xml data file, and have same name (but different extensions).

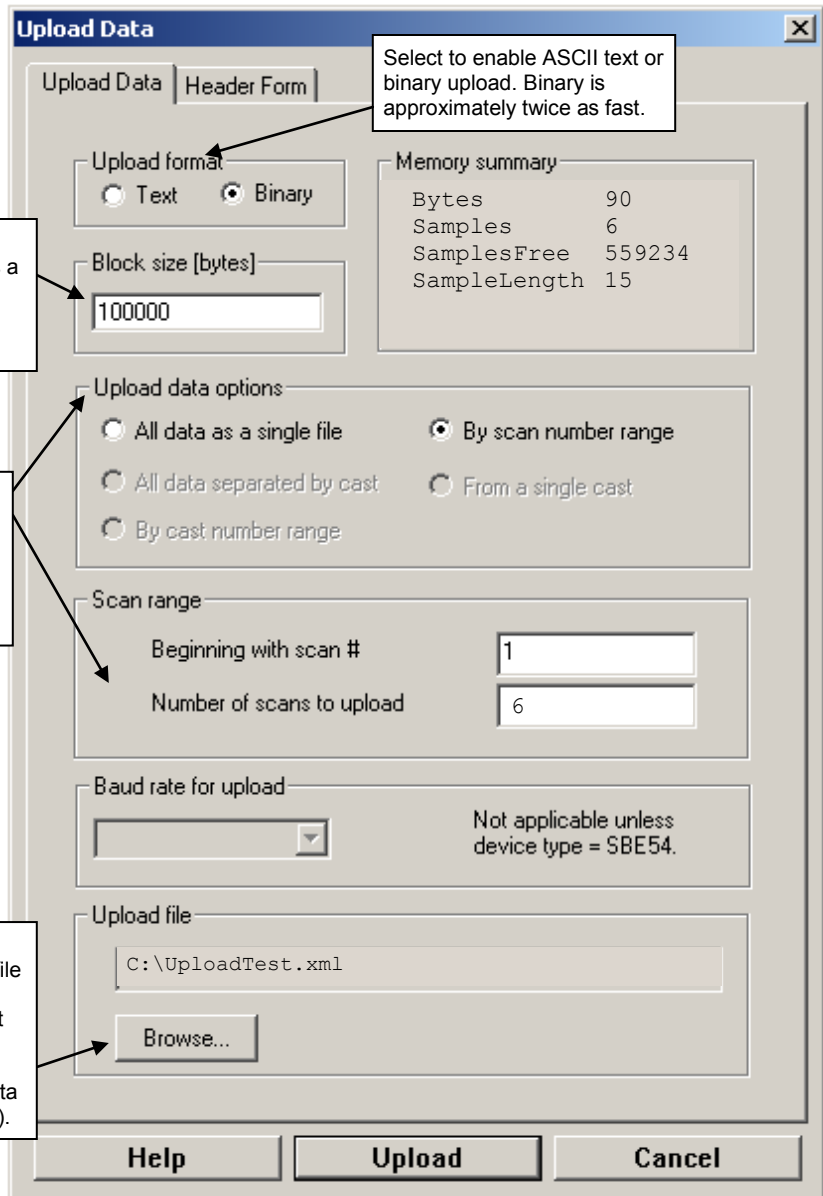

Make the desired selections.

8. Click the Header Form tab to customize the header:

Defines header information included with uploaded data:

- Prompt for header information – As data is uploaded, user is prompted to fill out user-defined header form.
- Include default header form in upload file – User-defined default header form included in upload file. User is not prompted to add any information when data is uploaded.
- Don't include default header form in upload file – Header information not included in upload file.

The entries are free form, 0 to 12 lines long. This dialog box establishes:

- the header prompts that appear for the user to fill in when uploading data, if *Prompt for header information* was selected
- the header included with the uploaded data, if *Include default header form in upload file* was selected

Enter the desired header/header prompts.

9. Click Upload; the Status bar at the bottom of the window displays the upload progress:
- Seaterm232 sends several status commands providing information regarding the number of samples in memory, calibration coefficients, etc., and writes the responses to the upload .xml file.
 - If you selected *Prompt for header information in the Upload Data dialog box*** – a dialog box with the header form appears. Enter the desired header information, and click OK. Seaterm232 writes the header information to the upload .xml file.
 - Seaterm232 sends the data upload command, based on your selection of upload range in the Upload Data dialog box, and writes the data to the upload .xml file.
 - From the information in the .xml file, Seaterm232 creates a .hex data file and .xmlcon configuration file that are compatible with SBE Data Processing for processing and plotting the data. These files are placed in the same directory as the .xml data file and have the same name (but different extensions).

Note:

SeatermV2 with version < 1.1 did not convert the uploaded .xml data file to a .hex and .xmlcon file. *Convert .XML data file* in the Tools menu was used to convert the .xml data file to a .cnv file, which could be processed in SBE Data Processing. We recommend that you update your SeatermV2 software to 1.1b or later.

Notes:

- Ensure all data has been uploaded from the MicroCAT by reviewing the data in SBE Data Processing.
- If you do not run Data Conversion now, you can run it later by opening SBE Data Processing.
- See the SBE Data Processing manual and/or Help for details.

10. After the data has been uploaded, Seaterm232 prompts you to run SBE Data Processing’s Data Conversion module if desired. Data Conversion converts the .hex (raw data) file to a .cnv file, which can then be processed by other modules in SBE Data Processing.

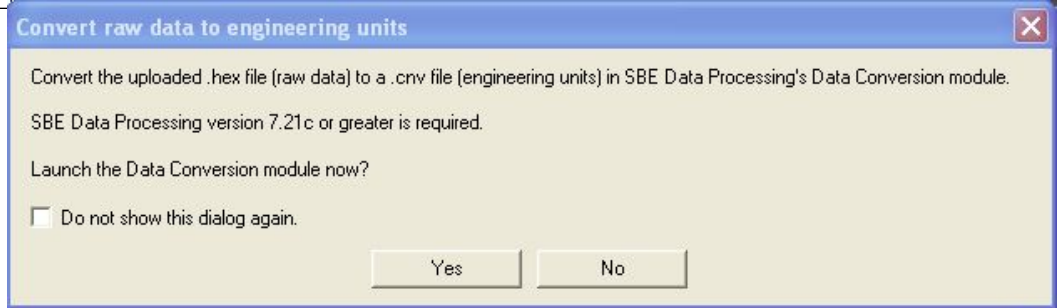

- A. If you click Yes, Seaterm232 opens SBE Data Processing’s Data Conversion module, and fills in the appropriate instrument configuration (.xmlcon) file and data (.hex) file on the File Setup tab.

Location to store all setup information. Default is directory with SeatermV2 application data, when Data Conversion is launched from Seaterm232.

Instrument configuration (.xmlcon) file location, which is created by Seaterm232, and contains MicroCAT’s calibration coefficients (see dialog box below).

Directory and file name for raw data (.hex) file created by Seaterm232 from uploaded data.

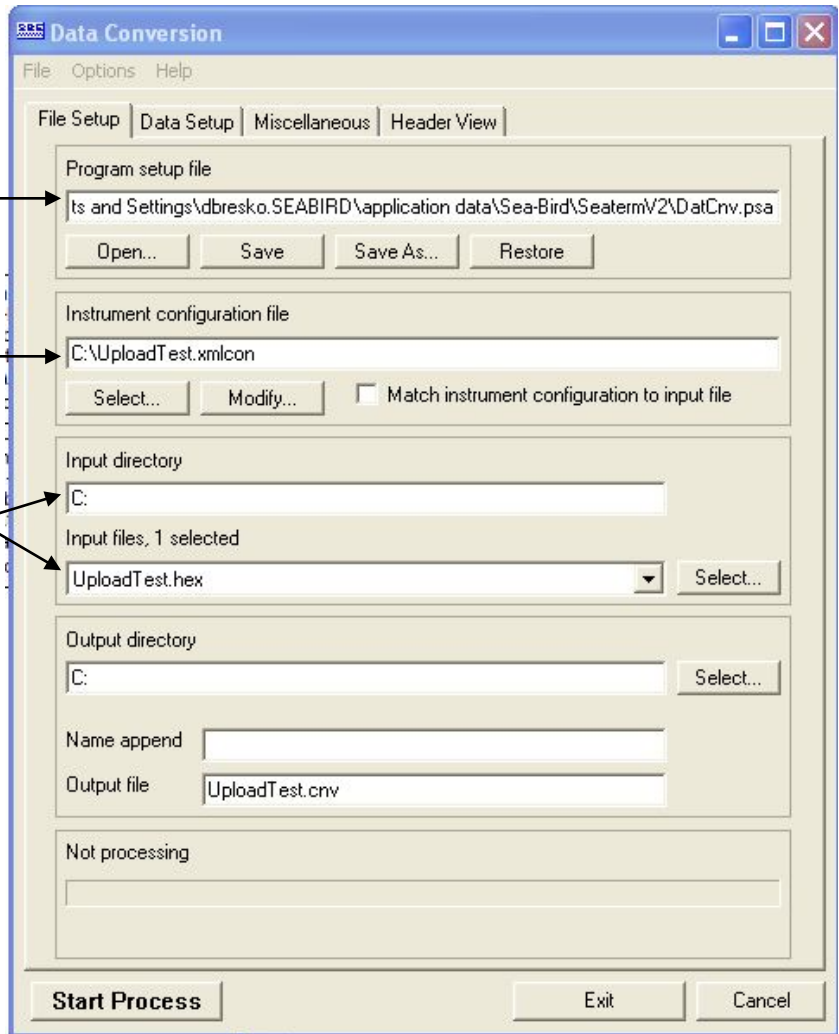

The Configuration dialog box (which appears if you click *Modify* on the File Setup tab) looks like this:

Configuration for the SBE 37 Microcat

Configuration file opened: UploadTest.xmlcon

Sample interval seconds: 10

Pressure sensor

Oxygen sensor: None

Deployment pressure dbar: 100

Deployment latitude: 0

Use deployment latitude in depth calculations

Channel	Sensor
1. Count	Temperature
2. Frequency	Conductivity

Buttons: New, Open..., Save, Save As..., Modify..., Report..., Help..., Exit, Cancel

Callout 1 (Left): Indicates if MicroCAT includes pressure sensor. If no pressure sensor included, deployment pressure is used to calculate conductivity (and derived variables such as salinity and sound velocity). Value shown is based on **ReferencePressure**= that was programmed into MicroCAT; **you can change this value in .xmlcon file, if you have updated deployment depth information.**

Callout 2 (Top Right): Time between scans. Must agree with MicroCAT setup; see reply from **GetCD** or **DS**. Value shown is based on:
 • If **SampleMode=2: SampleInterval=**
 • If **SampleMode=3:**
 1 sec if MicroCAT has no pressure sensor, 1.5 sec if MicroCAT has pressure sensor

Callout 3 (Middle Right): Indicates whether MicroCAT includes integrated dissolved oxygen sensor (IDO or ODO MicroCATs only).

Callout 4 (Bottom Right): Latitude is used to calculate local gravity (to calculate salt water depth). If enabled, software uses input latitude in calculation. If disabled, software uses Latitude on Miscellaneous tab of Data Conversion. **Enter latitude for your deployment.**

Callout 5 (Bottom Center): Double click on sensor to view and/or modify calibration coefficients, which are based on calibration coefficients that were programmed into MicroCAT.

The settings in the .xmlcon file created by Seaterm232 are based on the setup of the MicroCAT.

- Review the deployment latitude, and modify as needed.
- If your MicroCAT does not have a pressure sensor, review the deployment pressure, and modify as needed.

Click Save if you made any changes, and then click Exit.

B. Click on the Data Setup tab.

Data Conversion

File Options Help

File Setup Data Setup Miscellaneous Header View

Process scans to end of file

Scans to skip over:

Scans to process:

Output format: ASCII output

Convert data from: Upcast and downcast

Create file types: Create converted data (.CNV) file only

Source of scan range data: Scans marked with bottle confirm bit

Scan range offset [s]:

Scan range duration [s]:

Merge separate header file

Select Output Variables...

Source for start time in output .cnv header:

Instrument's time stamp System UTC

NMEA time Upload time

Prompt for start time and/or note

Start Process Exit Cancel

The Select Output Variables dialog box (which appears when you click *Select Output Variables* on the Data Setup tab) looks like this:

Select Output Variables

Seq. #	Variable Name [unit]
1	Conductivity [S/m]
2	Temperature [ITS-90, deg C]
3	Pressure, Strain Gauge [db]
4	Salinity, Practical [PSU]
5	Density [density, Kg/m^3]
6	Sound Velocity [Chen-Millero, m/s]
7	
8	

Buttons: Add, Change, Delete, Insert, Delete All, Data...

Available Variables List:

- Depth
- Frequency Channel
- Nitrogen Saturation
- Oxygen Saturation, Garcia & Gordon
- Oxygen Saturation, Weiss
- Potential Temperature
- Potential Temperature Anomaly
- Pressure, Strain Gauge
 - db
 - psi
- Salinity, Practical [PSU]
- Scan Count
- Sound Velocity
 - Chen-Millero
 - m/s
 - ft/s
 - Delgrossio
 - Wilson

Shrink All, Expand All, Shrink, Expand

OK Cancel

Select Temperature, Conductivity, and Pressure (optional), as well as desired derived variables such as salinity, sound velocity, etc. Click OK.

C. At the bottom of the Data Conversion dialog box, click Start Process to convert the .hex file to a .cnv file.

Notes:

To prepare for re-deployment:

1. After all data has been uploaded, send **InitLogging**. If this is not sent, new data will be stored after the last sample, preventing use of the entire memory.
2. Do *one* of the following:
 - Send **QS** to put the MicroCAT in quiescent (sleep) state until ready to redeploy.
 - Use **Start** to begin sampling immediately.

11. Once the data is converted to a .cnv file, use the other SBE Data Processing modules as desired:
 - Derive module - Calculate additional derived variables.
 - Sea Plot module - Plot data.

Editing Raw Data File

Sometimes users want to edit the raw .hex data file before beginning processing, to remove data at the beginning of the file corresponding to instrument *soak* time, remove blocks of bad data, edit the header, or add explanatory notes . **Editing the raw .hex file can corrupt the data, making it impossible to perform further processing using Sea-Bird software.** Sea-Bird strongly recommends that you first convert the data to a .cnv file (using the Data Conversion module in SBE Data Processing), and then use other SBE Data Processing modules to edit the .cnv file as desired.

The procedure described below for editing a .hex data file has been found to work correctly on computers running Windows 98, 2000, and NT. **If the editing is not performed using this technique, SBE Data Processing may reject the edited data file and give you an error message.**

Note:

Although we provide this technique for editing a raw .hex file, **Sea-Bird's strong recommendation, as described above, is to always convert the raw data file and then edit the converted file.**

1. **Make a back-up copy of your .hex data file before you begin.**
2. Run **WordPad**. In the File menu, select Open. The Open dialog box appears. For *Files of type*, select *All Documents (*.*)*. Browse to the desired .hex file and click Open.
3. Edit the file as desired, **inserting any new header lines after the System Upload Time line**. Note that all header lines must begin with an asterisk (*), and *END* indicates the end of the header. An example is shown below (for an SBE 21), with the added lines in bold:

```
* Sea-Bird SBE 21 Data File:
* FileName = C:\Odis\SAT2-ODIS\oct14-19\oc15_99.hex
* Software Version Seasave Win32 v1.10
* Temperature SN = 2366
* Conductivity SN = 2366
* System Upload Time = Oct 15 1999 10:57:19
* Testing adding header lines
* Must start with an asterisk
* Place anywhere between System Upload Time & END of header
* NMEA Latitude = 30 59.70 N
* NMEA Longitude = 081 37.93 W
* NMEA UTC (Time) = Oct 15 1999 10:57:19
* Store Lat/Lon Data = Append to Every Scan and Append to .NAV
File When <Ctrl F7> is Pressed
** Ship:          Sea-Bird
** Cruise:       Sea-Bird Header Test
** Station:
** Latitude:
** Longitude:
*END*
```
4. In the File menu, select Save (**not Save As**). If you are running Windows 2000, the following message displays:
You are about to save the document in a Text-Only format, which will remove all formatting. Are you sure you want to do this?
Ignore the message and click *Yes*.
5. In the File menu, select Exit.

Section 5: Routine Maintenance and Calibration

This section reviews corrosion precautions, connector mating and maintenance, conductivity cell storage and cleaning, pressure sensor maintenance, O-ring maintenance, plastic housing handling instructions, replacement of AF24173 Anti-Foulant Devices, and sensor calibration. The accuracy of the MicroCAT is sustained by the care and calibration of the sensors and by establishing proper handling practices.

Corrosion Precautions

Rinse the MicroCAT with fresh water after use and prior to storage.

All exposed metal is titanium; other materials are plastic. No corrosion precautions are required, but direct electrical connection of the MicroCAT housing to mooring or other dissimilar metal hardware should be avoided.

Connector Mating and Maintenance

Note:

See *Application Note 57: Connector Care and Cable Installation*.

CAUTIONS:

- **Do not use WD-40** or other petroleum-based lubricants, as they will damage the connectors.
- For wet-pluggable MCBH connectors: **Silicone lubricants in a spray can** may contain ketones, esters, ethers, alcohols, or glycols in their propellant. **Do not use these sprays, as they will damage the connector.**

Clean and inspect the connectors, cable, and dummy plug before every deployment and as part of your yearly equipment maintenance. Inspect connectors that are unmated for signs of corrosion product around the pins, and for cuts, nicks or other flaws that may compromise the seal.

When remating:

1. Lightly lubricate the inside of the dummy plug/cable connector with silicone grease (DC-4 or equivalent).
2. **XSG Connector** - Install the plug/cable connector, aligning the raised bump on the side of the plug/cable connector with the large pin (pin 1 - ground) on the MicroCAT. Remove any trapped air by *burping* or gently squeezing the plug/connector near the top and moving your fingers toward the end cap. **OR**
MCBH Connector – Install the plug/cable connector, aligning the pins.
3. Place the locking sleeve over the plug/cable connector. Tighten the locking sleeve finger tight only. **Do not overtighten the locking sleeve and do not use a wrench or pliers.**

Verify that a cable is installed on the MicroCAT before deployment.

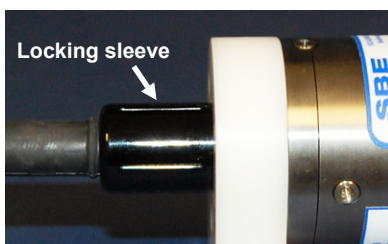
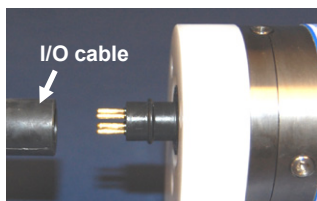

Conductivity Cell Maintenance

CAUTIONS:

- **Do not put a brush or any object inside the conductivity cell to clean it.** Touching and bending the electrodes can change the calibration. Large bends and movement of the electrodes can damage the cell.
- **Do not store the MicroCAT with water in the conductivity cell.** Freezing temperatures (for example, in Arctic environments or during air shipment) can break the conductivity cell if it is full of water.

The MicroCAT's conductivity cell is shipped dry to prevent freezing in shipping. Refer to *Application Note 2D: Instructions for Care and Cleaning of Conductivity Cells* for conductivity cell cleaning procedures and cleaning materials.

- The Active Use (after each cast) section of the application note is not applicable to the MicroCAT, which is intended for use as a moored instrument.

A conductivity cell filling and storage kit is available from Sea-Bird. The kit (PN 50087.1) includes a syringe and tubing assembly, and two anti-foulant device caps with hose barbs. The tubing cannot attach to an anti-foulant device cap that is not barbed.

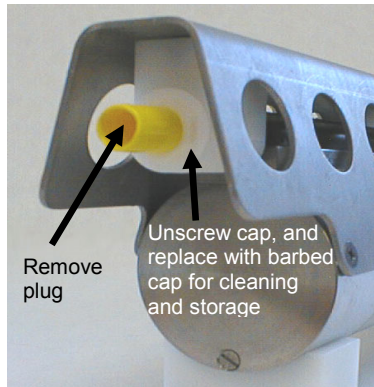

Cleaning and storage instructions require use of the syringe and tubing assembly at the intake end of the cell (requiring one barbed cap), and looping Tygon tubing from end to end of the cell (requiring two barbed caps). Remove the installed anti-foulant device cap(s) and replace them with the anti-foulant device cap(s) with hose barbs **for cleaning and storage only**. Remember to reinstall the original anti-foulant device cap(s) before deployment. **Deploying a MicroCAT with barbed anti-foulant device cap(s) in place of the installed caps is likely to produce undesirable results in your data.** See *Replacing Anti-Foulant Devices* for safety precautions when handling the AF24173 Anti-Foulant Devices.

Pressure Sensor (optional) Maintenance



Pressure sensor port plug

The pressure port plug has a small vent hole to allow hydrostatic pressure to be transmitted to the pressure sensor inside the instrument, while providing protection for the pressure sensor, keeping most particles and debris out of the pressure port.

Periodically (approximately once a year) inspect the pressure port to remove any particles, debris, etc.:

1. Unscrew the pressure port plug from the pressure port.
2. Rinse the pressure port with warm, de-ionized water to remove any particles, debris, etc.
3. Replace the pressure port plug.

CAUTION:

Do not put a brush or any object in the pressure port. Doing so may damage or break the pressure sensor.

O-Ring Maintenance

Note:

For details on recommended practices for cleaning, handling, lubricating, and installing O-rings, see the *Basic Maintenance of Sea-Bird Equipment* module in the Sea-Bird training materials on our website.

CAUTION:

Do not use Parker O-Lube, which is petroleum based; use only Super O-Lube.

Recommended inspection and replacement schedule:

- SBE 37-SI's O-rings are not normally disturbed. We recommend inspection and replacement approximately every 3 to 5 years.

Remove any water from the O-rings and mating surfaces in the housing with a lint-free cloth or tissue. Inspect O-rings and mating surfaces for dirt, nicks, and cuts. Clean or replace as necessary. Apply a light coat of O-ring lubricant (Parker Super O Lube) to O-rings and mating surfaces.

Handling Instructions for Plastic *ShallowCAT*

The MicroCAT's 7000-meter titanium housing offers the best durability with a modest amount of care. The *ShallowCAT*, a 350-meter plastic housing, saves money and weight. However, more care and caution in handling is required. To get the same excellent performance and longevity for the plastic-housing version, and if you need to access the electronics and/or remove the screws securing the conductivity cell guard to the housing (not typically done by the customer), observe the following precautions:

- The MicroCAT's end caps are retained by screws through the side of the housing. The screw holes are close to the end of the housing. Particularly in a cold environment, where plastic is more brittle, the potential for developing a crack around the screw hole(s) is greater for the plastic housing than for the titanium housing.
Observe the following precautions –
 - When removing end caps (to access the electronics), be careful to avoid any impact in this area of the housing.
 - When reinstalling end caps, do not use excess torque on the screws. Sea-Bird recommends tightening the screws to 15 inch-lbs. Alternatively, tighten the screws finger-tight, and then turn each screw an additional 45 degrees.
- A plastic housing is more susceptible to scratches than a titanium housing. Do not use screwdrivers or other metal tools to pry off the end caps.
 - Of primary concern are scratches on O-ring mating and sealing surfaces. Take extra precaution to avoid a scraping contact with these surfaces when re-seating the end cap.
 - Also take care to keep the O-ring lubricated surfaces clean – avoid trapping any sand or fine grit that can scratch the critical sealing surfaces. If the O-ring lubricant does accumulate any material or grit that can cause a leak or make a scratch, it must be carefully cleaned and replaced with fresh, clean lubricant (Parker Super O Lube).
 - Shallow, external scratches are cosmetic only, and will not affect the performance of the MicroCAT. However, deep external scratches can become points of weakness for deep deployments or fracture from impact during very cold weather.

CAUTION:
Do not use Parker O-Lube, which is petroleum based; use only Super O-Lube.

See *Appendix II: Electronics Disassembly / Reassembly* for detailed step-by-step procedures for removing the MicroCAT's end caps.

Replacing Anti-Foulant Devices (SBE 37-SI, SM, IM)



AF24173
Anti-Foulant
Device

The MicroCAT has an anti-foulant device cup and cap on each end of the cell. New MicroCATs are shipped with an Anti-Foulant Device and a protective plug pre-installed in each cup.

WARNING!

AF24173 Anti-Foulant Devices contain bis(tributyltin) oxide. Handle the devices only with rubber or latex gloves. Wear eye protection. Wash with soap and water after handling.

Read precautionary information on product label (see Appendix IV) before proceeding.

It is a violation of US Federal Law to use this product in a manner inconsistent with its labeling.

Wearing rubber or latex gloves, follow this procedure to replace each Anti-Foulant Device (two):

1. Remove the protective plug from the anti-foulant device cup;
2. Unscrew the cap with a $\frac{5}{8}$ -inch socket wrench;
3. Remove the old Anti-Foulant Device. If the old device is difficult to remove:

- Use needle-nose pliers and carefully break up material;
- If necessary, remove the guard to provide easier access.

Place the new Anti-Foulant Device in the cup;

4. Rethread the cap onto the cup. Do not over tighten;
5. If the MicroCAT is to be stored, reinstall the protective plug. **Note that the plugs must be removed prior to deployment or pressurization.** If the plugs are left in place during deployment, the cell will not register conductivity. If left in place during pressurization, the cell may be destroyed.

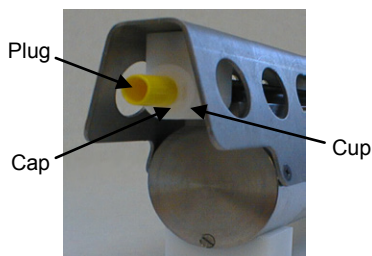
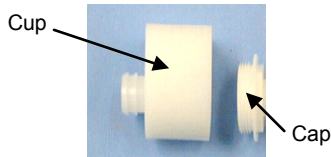

CAUTION:

Anti-foulant device cups are attached to the guard and connected with tubing to the cell. **Removing the guard without disconnecting the cups from the guard will break the cell.** If the guard must be removed:

1. Remove the two screws connecting each anti-foulant device cup to the guard.
2. Remove the four Phillips-head screws connecting the guard to the housing and sensor end cap.
3. Gently lift the guard away.

Sensor Calibration

Note:

Please remove AF24173 Anti-Foulant Devices from the anti-foulant device cups before returning the MicroCAT to Sea-Bird. Store them for future use. See *Replacing Anti-Foulant Devices* for removal procedure.

Sea-Bird sensors are calibrated by subjecting them to known physical conditions and measuring the sensor responses. Coefficients are then computed, which may be used with appropriate algorithms to obtain engineering units. The conductivity and temperature sensors on the MicroCAT are supplied fully calibrated, with coefficients printed on their respective Calibration Certificates (see back of manual). These coefficients have been stored in the MicroCAT's EEPROM.

We recommend that MicroCATs be returned to Sea-Bird for calibration.

Conductivity Sensor Calibration

The conductivity sensor incorporates a fixed precision resistor in parallel with the cell. When the cell is dry and in air, the sensor's electrical circuitry outputs a frequency representative of the fixed resistor. This frequency is recorded on the Calibration Certificate and should remain stable (within 1 Hz) over time.

The primary mechanism for calibration drift in conductivity sensors is the fouling of the cell by chemical or biological deposits. Fouling changes the cell geometry, resulting in a shift in cell constant.

Accordingly, the most important determinant of long-term sensor accuracy is the cleanliness of the cell. We recommend that the conductivity sensors be calibrated before and after deployment, but particularly when the cell has been exposed to contamination by oil slicks or biological material.

Temperature Sensor Calibration

The primary source of temperature sensor calibration drift is the aging of the thermistor element. Sensor drift will usually be a few thousandths of a degree during the first year, and less in subsequent intervals. Sensor drift is not substantially dependent upon the environmental conditions of use, and — unlike platinum or copper elements — the thermistor is insensitive to shock.

Pressure Sensor (optional) Calibration

The optional strain-gauge pressure sensor is a mechanical diaphragm type, with an initial static error band of 0.05%. Consequently, the sensor is capable of meeting MicroCAT's 0.10% error specification with some allowance for aging and ambient-temperature induced drift.

Pressure sensors show most of their error as a linear offset from zero.

A technique is provided below for making small corrections to the pressure sensor calibration using the *offset* (**POffset=**) calibration coefficient term by comparing MicroCAT pressure output to readings from a barometer.

Allow the MicroCAT to equilibrate in a reasonably constant temperature environment for at least 5 hours before starting. Pressure sensors exhibit a transient change in their output in response to changes in their environmental temperature. Sea-Bird instruments are constructed to minimize this by thermally decoupling the sensor from the body of the instrument. However, there is still some residual effect; allowing the MicroCAT to equilibrate before starting will provide the most accurate calibration correction.

Note:

The MicroCAT's pressure sensor is an absolute sensor, so its **raw** output (**OutputFormat=0**) includes the effect of atmospheric pressure (14.7 psi). As shown on the Calibration Sheet, Sea-Bird's calibration (and resulting calibration coefficients) is in terms of psia. However, when outputting pressure in **engineering units**, the MicroCAT outputs pressure relative to the ocean surface (i.e., at the surface the output pressure is 0 decibars). The MicroCAT uses the following equation to convert psia to decibars:

$$\text{Pressure (db)} = [\text{pressure (psia)} - 14.7] * 0.689476$$

1. Place the MicroCAT in the orientation it will have when deployed.
2. In Seaterm232:
 - A. Set the pressure offset to 0.0 (**POffset=0**).
 - B. Set the output format to converted decimal (**OutputFormat=1**), so the pressure output will be in decibars.
 - C. Send **TSN:100** to take 100 samples and transmit data.
3. Compare the MicroCAT output to the reading from a good barometer at the same elevation as the MicroCAT's pressure sensor port. Calculate *offset* = barometer reading – MicroCAT reading
4. Enter the calculated offset (positive or negative) in the MicroCAT's EEPROM, using **POffset=** in Seaterm232.

Offset Correction Example

Absolute pressure measured by a barometer is 1010.50 mbar. Pressure displayed from MicroCAT is -2.5 dbars.

Convert barometer reading to dbars using the relationship: mbar * 0.01 = dbar

Barometer reading = 1010.50 mbar * 0.01 = 10.1050 dbar

The MicroCAT's internal calculations output gage pressure, using an assumed value of 14.7 psi for atmospheric pressure. Convert MicroCAT reading from gage to absolute by adding 14.7 psia to the MicroCAT's output:

$-2.5 \text{ dbars} + (14.7 \text{ psi} * 0.689476 \text{ dbar/psia}) = -2.5 + 10.13 = 7.635 \text{ dbars}$

$\text{Offset} = 10.1050 - 7.635 = +2.47 \text{ dbars}$

Enter offset in MicroCAT.

For demanding applications, or where the sensor's air ambient pressure response has changed significantly, calibration using a dead-weight generator is recommended. The pressure sensor port uses a $7/16$ -20 straight thread for mechanical connection to the pressure source. Use a fitting that has an O-ring tapered seal, such as Swagelok-200-1-4ST, which conforms to MS16142 boss.

Section 6: Troubleshooting

This section reviews common problems in operating the MicroCAT, and provides the most common causes and solutions.

Problem 1: Unable to Communicate with MicroCAT

If **OutputExecutedTag=N**, the `S>` prompt indicates that communications between the MicroCAT and computer have been established. Before proceeding with troubleshooting, attempt to establish communications again by selecting *Connect* in the Communications menu in Seaterm232 or pressing the Enter key several times.

Cause/Solution 1: The I/O cable connection may be loose. Check the cabling between the MicroCAT and computer for a loose connection.

Cause/Solution 2: The instrument communication settings may not have been entered correctly in Seaterm232. Verify the settings in the Serial Port Configuration dialog box (Communications menu -> *Configure*). The settings should match those on the instrument Configuration Sheet.

Cause/Solution 3: The I/O cable between the MicroCAT and computer may not be the correct one. The I/O cable supplied with the MicroCAT permits connection to standard 9-pin RS-232 interfaces.

Problem 2: No Data Recorded

Cause/Solution 1: The memory may be full; once the memory is full, no further data is recorded. Verify that the memory is not full using **GetSD** or **DS** (*free = 0* or *1* if memory is full). Sea-Bird recommends that you upload all previous data before beginning another deployment. Once the data is uploaded, send **InitLogging** to reset the memory. After the memory is reset, **GetSD** or **DS** will show *samples = 0*.

Cause/Solution 2: **StoreData=** may be set to *no*. If it is set to *no*, data will be output real-time but will not be stored to memory. With **StoreData=Y**, **GetCD** or **DS** will show *store data* set to *yes*.

Problem 3: Unreasonable T, C, or P Data

The symptom of this problem is data that contains unreasonable values (for example, values that are outside the expected range of the data).

Cause/Solution 1: Data with unreasonable (i.e., out of the expected range) values for temperature, conductivity, or pressure may be caused by incorrect calibration coefficients in the MicroCAT. Send **GetCC** to verify the calibration coefficients in the MicroCAT match the instrument Calibration Certificates. Note that calibration coefficients do not affect the raw data stored in MicroCAT memory.

- If you have not yet overwritten the memory with new data, you can correct the coefficients and then upload the data again.
- If you have overwritten the memory with new data, you can manually correct the coefficients in the .xmlcon configuration file, and then reprocess the data in SBE Data Processing's Data Conversion module.

Problem 4: Salinity Spikes

Salinity is a function of conductivity, temperature, and pressure, and must be calculated from C, T, and P measurements made on the same parcel of water. Salinity is calculated and output by the 37-SI if **OutputSal=Y**. Alternatively, salinity can be calculated in SBE Data Processing's Data Conversion module from the data uploaded from memory (.hex file) or in SBE Data Processing's Derive module from the converted (.cnv) file.

[*Background information:* Salinity spikes in **profiling** (i.e., moving, fast sampling) instruments typically result from misalignment of the temperature and conductivity measurements in conditions with sharp gradients. This misalignment is often caused by differences in response times for the temperature and conductivity sensors, and can be corrected for in post-processing if the T and C response times are known.]

In **moored**, free-flushing instruments such as the 37-SI MicroCAT, wave action, mooring motion, and currents flush the conductivity cell at a faster rate than the environment changes, so the T and C measurements stay closely synchronized with the environment (i.e., even slow or varying response times are not significant factors in the salinity calculation). More typical causes of salinity spikes in a moored 37-SI include:

Cause/Solution 1: Severe external bio-fouling can restrict flow through the conductivity cell to such an extent that the conductivity measurement is significantly delayed from the temperature measurement.

Cause/Solution 2: For a MicroCAT moored at shallow depth, differential solar heating can cause the actual temperature inside the conductivity cell to differ from the temperature measured by the thermistor. Salinity spikes associated mainly with daytime measurements during sunny conditions may be caused by this phenomenon.

Cause/Solution 3: For a MicroCAT moored at shallow depth, air bubbles from breaking waves or spontaneous formation in supersaturated conditions can cause the conductivity cell to read low of correct.

Glossary

Fouling – Biological growth in the conductivity cell during deployment.

MicroCAT (SBE 37) – High-accuracy conductivity, temperature, and optional pressure Recorder/Sensor. A number of models are available:

- 37-IM (Inductive Modem, internal battery and memory)
- 37-IMP (Inductive Modem, internal battery and memory, integral Pump)
- 37-IMP-ODO (Inductive Modem, internal battery and memory, integral Pump, Optical Dissolved Oxygen sensor) – includes internal RS-232 interface
- 37-SM (Serial interface, internal battery and Memory)
- 37-SMP (Serial interface, internal battery and Memory, integral Pump)
- 37-SMP-ODO (Serial interface, internal battery and Memory, integral Pump, Optical Dissolved Oxygen sensor)
- 37-SI (Serial Interface, memory, no internal battery) *
- 37-SIP (Serial Interface, integral Pump, memory, no internal battery) *
- 37-SIP-IDO (Serial Interface, integral Pump, Integrated Dissolved Oxygen sensor, memory, no internal battery)

The serial interface versions are available with RS-232 or RS-485 interface. Some serial interface versions are also available with an SDI-12 interface.

* Note: Version 3.0 and later of the 37-SI and 37-SIP include memory; earlier versions did not include memory.

PCB – Printed Circuit Board.

SBE Data Processing - Sea-Bird's Windows data processing software, which calculates and plots temperature, conductivity, and optional pressure, and derives variables such as salinity and sound velocity.

Scan – One data sample containing temperature, conductivity, optional pressure, and optional date and time, as well as derived variables (depth, salinity, sound velocity, and density).

Seasoft V2 – Sea-Bird's complete Windows software package, which includes software for communication, real-time data acquisition, and data analysis and display. Seasoft V2 includes *SeatermV2* and *SBE Data Processing*.

SeatermV2 – Windows terminal program *launcher*, which launches the appropriate terminal program for the selected instrument (Seaterm232 for this MicroCAT).

Seaterm232 – Windows terminal program used with Sea-Bird instruments that communicate via an RS-232 interface, and that were developed or redesigned in 2006 and later. The common feature of these instruments is the ability to output data in XML.

Note:

IDO MicroCATs are integrated with SBE 43F DO sensors (Clark polarographic membrane type).
ODO MicroCATs are integrated with SBE 63 Optical DO sensors.

Note:

All Sea-Bird software listed was designed to work with a computer running Windows XP service pack 2 or later, Windows Vista, or Windows 7 (32-bit or 64-bit).

CAUTION:

Do not use Parker O-Lube, which is petroleum based; use only Super O-Lube.

Super O-Lube – Silicone lubricant used to lubricate O-rings and O-ring mating surfaces. Super O-Lube can be ordered from Sea-Bird, but should also be available locally from distributors. Super O-Lube is manufactured by Parker Hannifin; see www.parker.com/ead/cm2.asp?cmid=3956 for details.

TCXO – Temperature Compensated Crystal Oscillator.

Triton X-100 – Reagent grade non-ionic surfactant (detergent), used for cleaning the conductivity cell. Triton can be ordered from Sea-Bird, but should also be available locally from chemical supply or laboratory products companies. Triton is manufactured by Avantor Performance Materials (www.avantormaterials.com/commerce/product.aspx?id=2147509608).

Appendix I: Functional Description

Sensors

The MicroCAT embodies the same sensor elements (3-electrode, 2-terminal, borosilicate glass cell, and pressure-protected thermistor) previously employed in our modular SBE 3 and SBE 4 sensors and in the Seacat and Seacat *plus* family.

Note:

Pressure ranges are expressed in meters of deployment depth capability.

The MicroCAT's optional strain-gauge pressure sensor is available in the following pressure ranges: 20, 100, 350, 600, 1000, 2000, 3500, and 7000 meters. Compensation of the temperature influence on pressure offset and scale is performed by the MicroCAT's CPU.

Sensor Interface

Temperature is acquired by applying an AC excitation to a hermetically sealed VISHAY reference resistor and an ultra-stable aged thermistor with a drift rate of less than 0.002°C per year. A 24-bit A/D converter digitizes the outputs of the reference resistor and thermistor (and optional pressure sensor).

AC excitation and ratiometric comparison using a common processing channel avoids errors caused by parasitic thermocouples, offset voltages, leakage currents, and reference errors.

Conductivity is acquired using an ultra-precision Wien Bridge oscillator to generate a frequency output in response to changes in conductivity.

Real-Time Clock

To minimize power and improve clock accuracy, a temperature-compensated crystal oscillator (TCXO) is used as the real-time-clock frequency source. The TCXO is accurate to ± 1 minute per year (0 °C to 40 °C).

Memory

The MicroCAT has a 8-Mbyte non-volatile FLASH memory for data storage. FLASH memory is non-volatile, and data in the memory is not lost as a result of removed of external power. Because FLASH is written to a *page* (256 bytes) at a time, data is first accumulated in a 256-byte RAM buffer. When the buffer is full, its contents are transferred to FLASH memory. The buffer is volatile, and thus depends on external power. Therefore, any data that is in the buffer when external power is removed will be corrupted.

Conductivity and temperature are stored in 6 bytes/sample, time in 4 bytes/sample, and optional pressure in 5 bytes/sample. Thus, the 256-byte buffer can hold 25 samples of T, C, and time, or 17 samples, of T, C, P, and time. This is the maximum amount of data that will be corrupted each time external power is removed.

Example 1: You stop logging, do not upload data from memory, and remove external power when there are 256,000 bytes in FLASH memory and 100 bytes in the buffer. When you apply power and resume logging, the MicroCAT fills the remaining 156 bytes in the buffer with new data, writes the entire buffer to the FLASH memory, and continues logging and writing data to the buffer. The 100 bytes that were in the buffer when power was removed is corrupted; the data before it (from the first deployment) and the data after it (from the second deployment) are unaffected.

Example 2: You stop logging, upload data from memory, and remove external power when there are 256,000 bytes in FLASH memory and 100 bytes in the buffer. The MicroCAT correctly uploads the data in the FLASH memory as well as the data in the buffer.

Appendix II: Electronics Disassembly/Reassembly

Disassembly

CAUTION:

See Section 5: Routine Maintenance and Calibration for handling instructions for the plastic *ShallowCAT* housing.

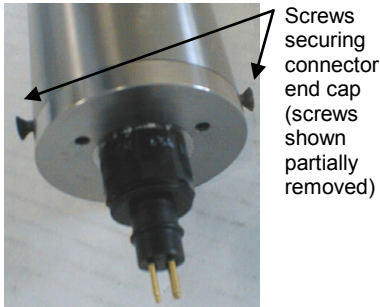

Screws securing connector end cap (screws shown partially removed)

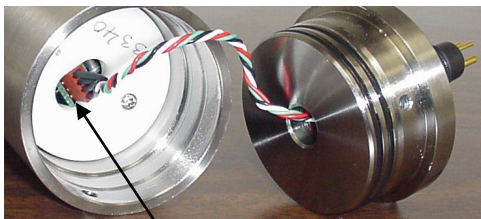

Molex connector

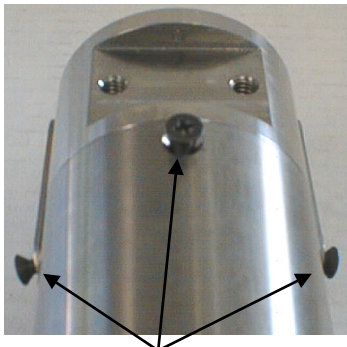

Screws securing sensor end cap (shown partially removed)

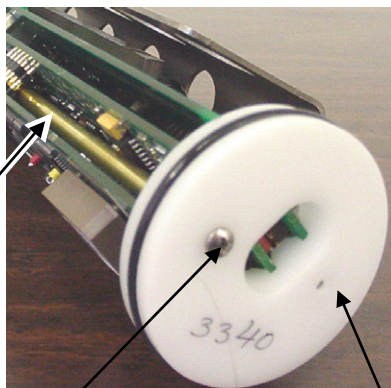

Brass sleeve

Screw securing electronics

Bulkhead

1. Remove the I/O connector end cap and disconnect the electronics from the end cap:
 - A. Wipe the outside of the I/O connector end cap and housing dry, being careful to remove any water at the seam between them.
 - B. Remove the two flat Phillips-head titanium machine screws. Do not remove any other screws from the housing.
Note: For plastic-housing MicroCATs shipped or retrofitted after July 2008, these are hex screws instead of Phillips-head screws. Sea-Bird ships the MicroCAT with a 9/64-inch Allen wrench for these screws.
 - C. Remove the I/O connector end cap by pulling on it firmly and steadily. It may be necessary to rock or twist the end cap back and forth or use a non-marring tool on the edge of the cap to loosen it.
 - D. The end cap is electrically connected to the electronics with a 4-pin Molex connector. Holding the wire cluster near the connector, pull gently to detach the female end of the connector from the pins.
 - E. Remove any water from the O-ring mating surfaces inside the housing with a lint-free cloth or tissue.
 - F. Put the end cap aside, being careful to protect the O-rings from damage or contamination.

2. Remove the housing from the electronics:
 - A. Wipe the outside of the sensor end cap and housing dry, being careful to remove any water at the seam between them.
 - B. Remove the two flat Phillips-head titanium machine screws connecting the guard to the housing and sensor end cap. Do not remove any other screws from the guard.
 - C. Remove the flat Phillips-head titanium machine screw connecting the housing to the sensor end cap.
Note: For plastic-housing MicroCATs shipped or retrofitted after July 2008, this is a hex screw instead of a Phillips-head screw. Sea-Bird ships the MicroCAT with a 9/64-inch Allen wrench for this screw.
 - D. Remove the housing by pulling it out firmly and steadily. It may be necessary to twist or rock the housing back and forth to loosen it.

3. The electronics are on a sandwich of three rectangular PCBs. These PCBs are assembled to a bulkhead. To remove the PCB assembly:
 - A. Remove the Phillips-head screw on the bulkhead that fits inside the small diameter brass sleeve. The Phillips-head screw is a 198 mm (7.8 inch) threaded rod with Phillips-head.
 - B. Pull out the PCB assembly by carefully grasping the bulkhead and pulling. The assembly will pull away from the 10-position edge connector used to connect to the cells.

Reassembly

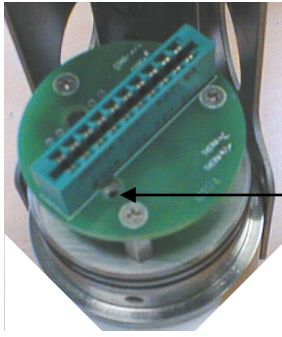

Align brass sleeve with hole

Note:

If the rod will not tighten, the PCBs have not fully mated or are mated in reverse.

CAUTION:

Do not use Parker O-Lube, which is petroleum based; use only Super O-Lube.

Note:

Before delivery, a desiccant package is inserted in the housing and the electronics chamber is filled with dry Argon gas. These measures help prevent condensation. To ensure proper functioning:

1. Install a new desiccant bag each time you open the electronics chamber. If a new bag is not available, see *Application Note 71: Desiccant Use and Regeneration (drying)*.
2. If possible, dry gas backfill each time you open the housing. If you cannot, wait at least 24 hours before redeploying, to allow the desiccant to remove any moisture from the housing.

1. Reinstall the electronics:
 - A. Align the brass sleeve with the hole for the Phillips-head screw, and push the PCB assembly into the 10-position edge connector.
 - B. Drop the Phillips-head screw into the hole and tighten gently.

2. Reinstall the housing on the sensor end cap:
 - A. Remove any water from the sensor end cap's O-rings and mating surfaces in the housing with a lint-free cloth or tissue. Inspect the O-rings and mating surfaces for dirt, nicks, and cuts. Clean as necessary. Apply a light coat of O-ring lubricant (Parker Super O Lube) to the O-rings and mating surfaces.
 - B. Carefully fit the housing onto the sensor end cap until the O-rings have fully seated.
 - C. Reinstall the three flat Phillips-head screws that connect the housing to the sensor end cap and the guard.

3. Reinstall the I/O connector end cap on the housing:
 - A. Remove any water from the I/O connector end cap's O-rings and mating surfaces in the housing with a lint-free cloth or tissue. Inspect the O-rings and mating surfaces for dirt, nicks, and cuts. Clean as necessary. Apply a light coat of O-ring lubricant (Parker Super O Lube) to the O-rings and mating surfaces.
 - B. Carefully fit the end cap into the housing until the O-rings have fully seated.
 - C. Reinstall the two flat Phillips-head screws that connect the end cap to the housing.

Appendix III: Command Summary

Note:

See *Command Descriptions* in *Section 4: Deploying and Operating MicroCAT* for detailed information and examples.

CATEGORY	COMMAND	DESCRIPTION
Status	GetCD	Get and display configuration data.
	GetSD	Get and display status data.
	GetCC	Get and display calibration coefficients.
	GetEC	Get and display event counter data.
	ResetEC	Reset event counter.
	GetHD	Get and display hardware data.
	DS	Get and display status and configuration data.
	DC	Get and display calibration coefficients.
General Setup	DateTime=mmddyyyyhhmmss	Set real-time clock month, day, year, hour, minute, second.
	BaudRate=x	x= baud rate (600, 1200, 2400, 4800, 9600, 19200, 38400, 57600, or 115200). Default 9600.
	OutputExecutedTag=x	x=Y: Display XML Executing and Executed tags. x=N: Do not.
	ReferencePressure=x	x = reference pressure (gauge) in decibars (used for conductivity, salinity, and sound velocity computation when MicroCAT does not have pressure sensor).
	QS	Quit session and place MicroCAT in quiescent (sleep) state.
Memory Setup	StoreData=x	x=Y: Store data to FLASH memory when sampling. x=N: Do not.
	InitLogging	Initialize logging to make entire memory available for recording.
	SampleNumber=x	x= sample number for last sample in memory. SampleNumber=0 equivalent to InitLogging .
Output Format Setup	OutputFormat=x	x=0: output raw decimal data. x=1: output converted decimal data. x=2: output converted decimal data in XML. x=3: output converted binary data. x=4: output converted decimal data, alternate format. x=5: output converted decimal data, BSH format.
	OutputTime=x	x=Y: output date and time. Only applies if OutputFormat=0, 1, 2, 4, or 5 . x=N: do not.
	OutputSal=x	x=Y: calculate and output salinity (psu). Only applies if OutputFormat=1, 2, 4, or 5 . x=N: do not.
	OutputSV=x	x=Y: calculate and output sound velocity (m/sec). Only applies if OutputFormat=1, 2, 4, or 5 . x=N: do not.
	OutputDensity=x	x=Y: calculate and output local density (kg/m ³). Only applies if OutputFormat=1, 2, 4, or 5 . x=N: do not.
	OutputDepth=x	x=Y: calculate and output depth (meters). Only applies if OutputFormat=1, 2, 4, or 5 . x=N: do not.
	Latitude=x	x = latitude (degrees) to use in depth calculation.

CATEGORY	COMMAND	DESCRIPTION
Operating	SampleMode=x	x=1 : When commanded to sample, take 1 sample. x=2 : When commanded to sample, sample at intervals defined by SampleInterval= . x=3 : When commanded to sample, sample continuously.
	SampleInterval=x or Interval=x	x = interval (seconds) between samples (6 - 21600) if SampleMode=2 .
	AutoRun=x	x=Y : When power applied, automatically sample as defined by SampleMode= . x=N : When power applied, do not begin to automatically sample.
	Start or Go	Start sampling, as defined by SampleMode= .
	Stop	Stop sampling. Must send Stop before uploading data.
Polled Sampling	TS	Take sample, store in buffer, output data.
	TSH	Take sample, store in buffer (do not output).
	TSS	Take sample, store in buffer and in FLASH memory, output data.
	TSN:x	Take x samples and output data.
	SL	Output last sample stored in buffer.
	SLT	Output last sample stored in buffer, then take new sample and store in buffer (do not output data from new sample).
Data Upload (send Stop before sending upload command)	GetSamples:b,e	Upload scan b to scan e , in format defined by OutputFormat= .
	DDb,e	Upload scan b to scan e , in alternate converted decimal form (OutputFormat=4) (regardless of setting for OutputFormat=).
Calibration Coefficients (F=floating point number; S=string with no spaces) Calibration coefficients are initially factory-set and should agree with Calibration Certificates shipped with MicroCATs. View all coefficients with GetCC or DC .	TCalDate=S	S =Temperature calibration date.
	TA0=F	F =Temperature A0.
	TA1=F	F =Temperature A1.
	TA2=F	F =Temperature A2.
	TA3=F	F =Temperature A3.
	CCalDate=S	S =Conductivity calibration date.
	CG=F	F =Conductivity G.
	CH=F	F =Conductivity H.
	CI=F	F =Conductivity I.
	CJ=F	F =Conductivity J.
	WBOTC=F	F =Conductivity wbotc.
	CTCor=F	F =Conductivity ccor.
	CPCor=F	F =Conductivity cpcor.
	PCalDate=S	S =Pressure calibration date.
	PA0=F	F =Pressure A0.
	PA1=F	F =Pressure A1.
	PA2=F	F =Pressure A2.
	PTCA0=F	F =Pressure ptca0.
	PTCA1=F	F =Pressure ptca1.
	PTCA2=F	F =Pressure ptca2.
	PTCB0=F	F =Pressure ptcb0.
	PTCB1=F	F =Pressure ptcb1.
	PTCB2=F	F =Pressure ptcb2.
PTempA0=F	F =Pressure temperature a0.	
PTempA1=F	F =Pressure temperature a1.	
PTempA2=F	F =Pressure temperature a2.	
POffset=F	F =Pressure offset (decibars).	

Note:
Use Seaterm232's Upload menu to upload data that will be processed by SBE Data Processing. Manually entering a data upload command does not produce data with the required header information for processing by SBE Data Processing.

Note:

For consistency with user systems set up for older firmware (< 3.0), the following commands were re-introduced with firmware 3.0j:

- **Interval=** (equivalent to **SampleInterval=** in current firmware)
- **Go** (equivalent to **Start** in current firmware)
- **NCycles=** (no equivalent command in current firmware; this parameter is always set internally to 4. MicroCAT now accepts this command, but does not change any settings or internal calculations.)

Appendix IV: AF24173 Anti-Foulant Device

AF24173 Anti-Foulant Devices supplied for user replacement are supplied in polyethylene bags displaying the following label:

AF24173 ANTI-FOULANT DEVICE

FOR USE ONLY IN SEA-BIRD ELECTRONICS' CONDUCTIVITY SENSORS TO CONTROL THE GROWTH OF AQUATIC ORGANISMS WITHIN ELECTRONIC CONDUCTIVITY SENSORS.

ACTIVE INGREDIENT:

Bis(tributyltin) oxide.....	53.0%
OTHER INGREDIENTS:	<u>47.0%</u>
Total.....	100.0%

DANGER

See the complete label within the Conductivity Instrument Manual for Additional Precautionary Statements and Information on the Handling, Storage, and Disposal of this Product.

Net Contents: Two anti-foulant devices

Sea-Bird Electronics, Inc.
13431 NE 20th Street
Bellevue, WA 98005

EPA Registration No. 74489-1
EPA Establishment No. 74489-WA-1

AF24173 Anti-Foulant Device

FOR USE ONLY IN SEA-BIRD ELECTRONICS' CONDUCTIVITY SENSORS TO CONTROL THE GROWTH OF AQUATIC ORGANISMS WITHIN ELECTRONIC CONDUCTIVITY SENSORS.

ACTIVE INGREDIENT:

Bis(tributyltin) oxide.....	53.0%
OTHER INGREDIENTS:	47.0%
Total.....	100.0%

DANGER

See Precautionary Statements for additional information.

FIRST AID	
If on skin or clothing	<ul style="list-style-type: none"> • Take off contaminated clothing. • Rinse skin immediately with plenty of water for 15-20 minutes. • Call a poison control center or doctor for treatment advice.
If swallowed	<ul style="list-style-type: none"> • Call poison control center or doctor immediately for treatment advice. • Have person drink several glasses of water. • Do not induce vomiting. • Do not give anything by mouth to an unconscious person.
If in eyes	<ul style="list-style-type: none"> • Hold eye open and rinse slowly and gently with water for 15-20 minutes. • Remove contact lenses, if present, after the first 5 minutes, then continue rinsing eye. • Call a poison control center or doctor for treatment advice.
HOT LINE NUMBER	
Note to Physician	Probable mucosal damage may contraindicate the use of gastric lavage.
Have the product container or label with you when calling a poison control center or doctor, or going for treatment. For further information call National Pesticide Telecommunications Network (NPTN) at 1-800-858-7378.	

Net Contents: Two anti-foulant devices

Sea-Bird Electronics, Inc.
 13431 NE 20th Street
 Bellevue, WA 98005

EPA Registration No. 74489-1
 EPA Establishment No. 74489-WA-1

PRECAUTIONARY STATEMENTS

HAZARD TO HUMANS AND DOMESTIC ANIMALS

DANGER

Corrosive - Causes irreversible eye damage and skin burns. Harmful if swallowed. Harmful if absorbed through the skin or inhaled. Prolonged or frequently repeated contact may cause allergic reactions in some individuals. Wash thoroughly with soap and water after handling.

PERSONAL PROTECTIVE EQUIPMENT

USER SAFETY RECOMMENDATIONS

Users should:

- Remove clothing immediately if pesticide gets inside. Then wash thoroughly and put on clean clothing.
- Wear protective gloves (rubber or latex), goggles or other eye protection, and clothing to minimize contact.
- Follow manufacturer's instructions for cleaning and maintaining PPE. If no such instructions for washables, use detergent and hot water. Keep and wash PPE separately from other laundry.
- Wash hands with soap and water before eating, drinking, chewing gum, using tobacco or using the toilet.

ENVIRONMENTAL HAZARDS

Do not discharge effluent containing this product into lakes, streams, ponds, estuaries, oceans, or other waters unless in accordance with the requirements of a National Pollutant Discharge Elimination System (NPDES) permit and the permitting authority has been notified in writing prior to discharge. Do not discharge effluent containing this product to sewer systems without previously notifying the local sewage treatment plant authority. For guidance contact your State Water Board or Regional Office of EPA. This material is toxic to fish. Do not contaminate water when cleaning equipment or disposing of equipment washwaters.

PHYSICAL OR CHEMICAL HAZARDS

Do not use or store near heat or open flame. Avoid contact with acids and oxidizers.

DIRECTIONS FOR USE

It is a violation of Federal Law to use this product in a manner inconsistent with its labeling. For use only in Sea-Bird Electronics' conductivity sensors. Read installation instructions in the applicable Conductivity Instrument Manual.

STORAGE AND DISPOSAL

PESTICIDE STORAGE: Store in original container in a cool, dry place. Prevent exposure to heat or flame. Do not store near acids or oxidizers. Keep container tightly closed.

PESTICIDE SPILL PROCEDURE: In case of a spill, absorb spills with absorbent material. Put saturated absorbent material to a labeled container for treatment or disposal.

PESTICIDE DISPOSAL: Pesticide that cannot be used according to label instructions must be disposed of according to Federal or approved State procedures under Subtitle C of the Resource Conservation and Recovery Act.

CONTAINER HANDLING: Nonrefillable container. Do not reuse this container for any other purpose. Offer for recycling, if available.

Appendix V: Replacement Parts

Part Number	Part	Application Description	Quantity in MicroCAT
801542	AF24173 Anti-Foulant Device	Bis(tributyltin) oxide device inserted into anti-foulant device cup	1 (set of 2)
233539	Anti-foulant device cup	Holds AF24173 Anti-Foulant Device	2
233540	Anti-foulant device cap	Secures AF24173 Anti-Foulant Device in cup	2
30984	Plug	Seals end of anti-foulant cap when not deployed, keeping dust and aerosols out of conductivity cell during storage	2
30411	Triton X-100	Octyl Phenol Ethoxylate – Reagent grade non-ionic cleaning solution for conductivity cell (supplied in 100% strength; dilute as directed)	-
50087.1	Conductivity cell filling & storage device with hose barb caps	For cleaning and storing conductivity cell	-
30507	Parker 2-206N674-70 O-ring	O-ring between end of conductivity cell and anti-foulant device cup	2
60034	Spare hardware/O-ring kit for 37-SI / -SIP with titanium housing	Assorted hardware and O-rings, including: <ul style="list-style-type: none"> • 30859 Machine screw, 8-32 x 3/8" FH, titanium (secures housing to I/O connector end cap, housing to sensor end cap, and guard to sensor end cap) • 30857 Parker 2-033E515-80 O-ring (I/O connector end cap and sensor end cap O-ring) • 30544 Machine screw, 8-32 x 1/2" FH, titanium (secures guard to sensor end cap through holes that also secure housing to end cap) • 30860 Screw, 6-32 x 1/2 FH, titanium (secures cable clamp half to flat area of sensor end cap) • 30900 Bolt, 1/4-20 x 2" hex head, titanium (secures mounting clamp) • 30633 Washer, 1/4" split ring lock, titanium (for 30900) • 30634 Washer 1/4" flat, titanium (for 30900) • 31019 O-ring Parker 2-008 N674-70 (for 30900 – retains mounting clamp hardware) • 31040 Screw, 8-32 x 1 FH, TI (secures cable guide base to I/O connector end cap) 	-

Continued on next page

Continued from previous page

Part Number	Part	Application Description	Quantity in MicroCAT
60051	Spare hardware/ O-ring kit for 37-SI / -SIP with plastic housing	Assorted hardware and O-rings, including: <ul style="list-style-type: none"> • 30859 Machine screw, 8-32 x 3/8" FH, titanium (secures housing to I/O connector end cap, housing to sensor end cap, and guard to sensor end cap) • 30857 Parker 2-033E515-70 O-ring (I/O connector end cap and sensor end cap O-ring) • 30544 Machine screw, 8-32 x 1/2" FH, titanium (secures guard to sensor end cap through holes that also secure housing to end cap) • 30860 Screw, 6-32 x 1/2 FH, titanium (secures cable clamp half to flat area of sensor end cap) • 30900 Bolt, 1/4-20 x 2" hex head, titanium (secures mounting clamp) • 30633 Washer, 1/4" split ring lock, titanium (for 30900) • 30634 Washer 1/4" flat, titanium (for 30900) • 31019 O-ring Parker 2-008 N674-70 (for 30900 – retains mounting clamp hardware) • 31040 Screw, 8-32 x 1 FH, titanium (secures cable guide base to I/O connector end cap) • 31755 Cap screw, 8-32 x 1/4" SH, titanium (secures connector end cap to housing) • 31516 Hex key, 9/64 inch long arm (for installing 31755) 	-
801385	4-pin RMG-4FS to 9-pin DB-9S I/O cable with power leads, 2.4 m (8 ft)	From MicroCAT to computer	1
801206	4-pin MCIL-4FS (wet-pluggable connector) to 9-pin DB-9S I/O cable with power leads, 2.4 m (8 ft)	From MicroCAT to computer	1
17046.1	4-pin RMG-4FS dummy plug with locking sleeve	For when I/O cable not used	1
171398.1	4-pin MCDC-4F (wet-pluggable connector) dummy plug with locking sleeve	For when I/O cable not used	1
17043	Locking sleeve for RMG cable	Locks I/O cable or dummy plug in place	1
171192	Locking sleeve for MCIL cable	Locks I/O cable or dummy plug in place	1

Appendix VI: Manual Revision History

Manual Version	Date	Description
008	10/99	<ul style="list-style-type: none"> Rewrite.
009	11/99	<ul style="list-style-type: none"> Design change from potted to modular (take apart).
010	12/99	<ul style="list-style-type: none"> Firmware 2.1: add Latitude=, OutputDensity=, and OutputDepth=.
011	09/00	<ul style="list-style-type: none"> Changes related to firmware version 2.2. Change to Druck pressure sensor. Incorporate Seaterm. Correct pressure port size. Add information and drawing of brackets. Remove 'optically-isolated' from description. Remove reference to Seasoft for post-processing.
012	01/01	<ul style="list-style-type: none"> Minor update to specifications for consistency with new data sheet. Add more description of effect of NCycles= on sampling rate.
013	02/02	<ul style="list-style-type: none"> Add 2000 m pressure sensor. Add connector diagram for wet-pluggable connector. Correct sample timing calculation. Add explanation that output density is σ (s,t,p).
014	12/02	<ul style="list-style-type: none"> Add caution that setting time without date resets date to last date set with ddmmyy= or mmddyy=. Add information on baud rate, sampling time, and cable length. Correct pressure sensor calibration fitting. Anti-foul information: use EPA-approved descriptions and labels.
015	01/03	<ul style="list-style-type: none"> Add AF label information in appendix.
016	11/03	<ul style="list-style-type: none"> Design change: update photos showing molex connection. Add information that reference pressure line appears in DS reply only if no pressure sensor. Update replacement parts list to include contents of spares kit. Update Seaterm screens.
017	03/04	<ul style="list-style-type: none"> Add information that if jumper set in autopower position, 37-SI won't go to sleep between samples, but it will still sample at the set interval. Update power and cable length section.
018	06/04	<ul style="list-style-type: none"> Firmware 2.3: new board layout, new power specifications. Update power consumption / cable length calculations.
019	05/05	<ul style="list-style-type: none"> Add 600 m Druck pressure sensor. Update cleaning recommendations to correspond to revised application note 2D. Update AF24173 Anti-Foulant Device appendix to current label. Add troubleshooting section.
020	05/06	<ul style="list-style-type: none"> Add information that 37-SI does not 'go to sleep' between samples when interval > 10 sec, regardless of jumper setting. Update wet-pluggable connector information. Add more information to Recovery Warning.
021	11/06	<ul style="list-style-type: none"> Add option for plastic housing. Add more explanation of NCycles=. Update pressure port maintenance – SBE no longer putting silicon oil in port.
022	06/07	<ul style="list-style-type: none"> Add handling precautions for plastic housing.
023	04/08	<ul style="list-style-type: none"> Update for Version 3 firmware changes: 37-SI now has memory, many commands changed, power specifications changed. Change stability specification for pressure to per year instead of per month. Update connector maintenance information for consistency with application note 57. Add information that POffset is in decibars.

Continued on next page

Continued from previous page

024	08/08	<ul style="list-style-type: none"> Firmware revision 3.0d: new output format to match format available from firmware < 3.0. DDb,e uploads data in this new output format. Manufacturing change: for plastic housing, 2 phillips-head screws at connector end cap end and 1 at sensor end cap end are replaced with hex screws. 9/64" allen wrench shipped with instrument. Remove SetPCBSerialNum commands.
025	01/09	<ul style="list-style-type: none"> Update for SeatermV2 terminal program. Firmware updates: <ul style="list-style-type: none"> Add OutputFormat=5 (same as old Format=2), says "converted engineering BSH" in status. If no pressure sensor, reference pressure appears in GetCD (only if pressureinstalled=no). Does not appear in DC, appears in DS instead (only if pressureinstalled=no) Add information that when external power removed, any data in 256 byte Ram buffer does not get put in FLASH RAM. Add information about compatibility with Vista. Correction: Add PTempA0, PTempA1, PTempA2 to calibration coefficient commands.
026	01/10	<ul style="list-style-type: none"> Change Seasoft-Win32 to Seasoft V2, update file name to SeasoftV2_date.exe. SBE Data Processing 7.20a: Add information about .xmlcon file. Add CE mark. Update SBE address. Update anti-foul label in Appendix with new Container Handling requirement and new address.
027	07/10	<ul style="list-style-type: none"> Firmware 3.0j added following 3 commands for compatibility with firmware < 3.0: Go (same as Start), Interval= (same as SampleInterval=), NCycles= (accepts command but does nothing). Add 60051 spares kit for plastic housing.
028	10/10	<ul style="list-style-type: none"> Update for changes to SeatermV2 version 1.1 (upload now converts .xml file to .hex and .xmlcon files, which are used in Data Conversion to convert to .cnv file for further processing). Troubleshooting, Problem 2 (no data recorded): add that StoreData=N will prevent data from being stored to memory. Remove references to Druck pressure sensors (pressure sensors can be supplied by other manufacturers).
029	03/11	<ul style="list-style-type: none"> SeatermV2 1.1b changes: <ul style="list-style-type: none"> Update upload procedure, Seaterm232 now automatically starts SBE Data Processing after upload. Update SeatermV2 Instruments list screen capture. Add information about compatibility with Windows 7.
030	08/12	<ul style="list-style-type: none"> Add Declaration of Conformity. Add cable and wiring diagrams. Add more information on selecting output variables for data processing of uploaded data. Update configuration dialog box in SBE Data Processing. Triton – update company name (Avantor Performance Materials) and link. Glossary - Add information on ODO MicroCATs Remove factory-set commands: SetPressureInstalled=, SetMfgDate=, SetPCBAssembly=, SetPCBSerialNum=. Fix typos.
031	09/13	<ul style="list-style-type: none"> Update plastic housing depth rating to 350 meters. Update SeatermV2 screen capture, and Seaterm232 Serial Port Config dialog box and Upload dialog box. Add information on use with high baud rates. Add information on editing raw .hex files. Update software compatibility information. Clarify that accuracy specifications are \pm. Glossary - Add information on SDI-12 MicroCATs. Update Declaration of Conformity. Fix typos.
032	03/14	<ul style="list-style-type: none"> Update temperature range and accuracy specifications. Add information on O-ring maintenance. Add caution on using spray can lubricants on MCBH connectors. Remove <i>standard</i> and <i>optional</i> language.

Continued on next page

Continued from previous page

033	02/15	<ul style="list-style-type: none">• Add information on PC settings for binary upload.• Add caution regarding using Parker Super O Lube, not Parker O Lube (which is petroleum based).• Update language on where to find updated software on website.• Remove 37-SMP-IDO, 37-IMP-IDO, and 37-SIP-ODO from MicroCAT listing in Glossary; not available.• Switch to Sea-Bird Scientific cover.
-----	-------	---

Index

.hex files
editing · 52

A

Anti-Foulant Device · 71
removal before shipping to Sea-Bird · 58
replacing · 57
Autonomous sampling · 22, 37

B

Baud rate · 24, 34

C

Cable length · 24, 25
Cables · 12
Calibration · 58
calibration coefficients · 39
CE certification · 3
Cleaning · 54
Clock · 10, 64
Command summary · 68
Commands
autonomous sampling · 37
baud rate · 34
calibration coefficients · 39
data format · 36
data upload · 38, 45
date and time · 34
descriptions · 26
general setup · 34
memory setup · 35
operating · 37
polled sampling · 38
serial line sync · 37
status · 27
upload · 45
Communication defaults · 17
Conductivity cell · 64
Conductivity cell cleaning · 54
Connector · 11, 53
Continuous sampling · 22, 37
Corrosion precautions · 53

D

Data Conversion · 49
Data format · 36, 40
Data processing · 9, 14, 45, 49
Data transmission rate · 24
Data upload · 38, 45
Date and time · 34
Declaration of Conformity · 3
Deployment
installation · 43
preparing for · 14
setup · 43

Derive · 49
Description · 8
Dimensions · 11

E

Editing data files · 52
Electronics disassembly/reassembly · 66
End cap · 11, 53
External power and memory · 20, 65

F

Flooded MicroCAT · 44
Format
data · 40
Functional description · 64

G

Glossary · 62
Guard
removal · 57

I

Initializing memory · 35
Interval sampling · 22, 37

M

Maintenance · 53
Manual revision history · 77
Memory · 10
Memory and power · 20, 65
Memory setup · 35
Modes · *See* Sampling modes
Mounting · 43

O

O-ring
maintenance · 55
Output format · 36, 40

P

Parker Super O-Lube · 63
Parts
replacement · 75
Plastic housing
handling · 56
Polled sampling · 21, 38
Power · 10, 25
Power and memory · 20, 65
Pressure sensor · 64
maintenance · 55
Processing data · 45

Q

Quick start · 6

R

Recovery · 44
 uploading data · 45
Replacement parts · 75
Revision history · 77

S

Sample timing · 13
Sampling modes · 20
 autonomous · 22
 polled · 21
 serial line sync · 23
SBE Data Processing · 9, 14, 49
Sea Plot · 49
Seasoft · 9, 14
Seaterm232 · 9, 14, 15, 45
SeatermV2 · 9, 14, 15, 45
Sensors · 10
Serial line sync · 23, 37
Setup commands · 34
ShallowCAT
 handling · 56
Software · 9, 14
Specifications · 10
Status commands · 27
Storage · 54
Super O-Lube · 63
System description · 8

T

Terminal program · 9, 14, 15, 45
Testing · 14
Thermistor · 64
Timeout description · 26
Triton · 63
Troubleshooting · 60

U

Unpacking MicroCAT · 7
Upload · 38
Uploading data · 45

V

Versions · 77

W

Wiring · 12, 14