

INSTRUCTION MANUAL

FOR LAMELLAR SHELTER LAM 630 COMPLETE



YEAR OF CONSTRUCTION : 2018
STATUS OF INSTRUCTION MANUAL: 01.02.2018

EIGENBRODT GmbH & Co. KG
ENVIRONMENTAL MEASUREMENT SYSTEMS
Baurat-Wiese-Straße 68
D-21255 Königsmoor

Telefon +49 (0) 4180 - 732 - Telefax +49 (0) 04180 - 259
E-mail : goto@eigenbrodt.de
Internet: www.eigenbrodt.de

Serial number: _____
(Please enter the serial number of your instrument here.)

TABLE OF CONTENTS

| | Page |
|---|------------|
| TABLE OF CONTENTS | 2-4 |
| I. TO OUR CUSTOMERS – READING THIS MANUAL | 4 |
| II. INSTRUCTIONS..... | 5 |
| 1. GENERAL | 5 |
| 2. INTENDED USE | 5 |
| 2.1. PERMITTED AMBIENT CONDITIONS | 5 |
| 3. PRINCIPLE OF OPERATION..... | 6 |
| 4. SAFETY INSTRUCTIONS | 6 |
| 4.1. SYMBOL AND HINT EXPLANATION..... | 7 |
| 4.2. SAFE WORKING WITH THE INSTRUMENT | 7 |
| 5. TRANSPORT AND RETURN | 8 |
| 6. DISPOSAL | 8 |
| III. TECHNICAL DATA..... | 9 |
| 1. ELECTRICAL DATA | 9 |
| 1.1. CONNECTED LOADS ELECTRICAL POWER SUPPLY | 9 |
| 2. RATINGS..... | 9 |
| 2.1. AREA REQUIRED OVERALL | 9 |
| 2.2. DIMENSIONS..... | 9 |
| 2.3. WEIGHT OVERALL..... | 9 |
| 2.4. WORKING TEMPERATURE | 9 |
| 2.5. SENSORS..... | 9 |
| 2.6. MOUNTING | 9 |
| IV. INSTALLATION AND SETTING INTO OPERATION..... | 10 |
| 1. LOCATION | 10 |
| 2. MECHANICAL INSTALLATION..... | 10 |
| 2.1. ELECTRICAL CONNECTIONS TO THE POWER SUPPLY | 11 |
| 3. MOUNTING THE SENSORS | 11 |
| V. OPERATION | 12 |
| 1. ADVICE FOR OPERATION..... | 12 |
| 2. TAMPERING, WARRANTY LIMITATION | 12 |
| 3. MAINTENANCE AND REPAIRS | 12 |
| 3.1. CARE OF INSTRUMENT | 12 |
| 3.2. MAINTENANCE WORKS..... | 12 |
| VI. TECNICAL DOCUMENTATION | 13 |

1. EXPLANATION OF COMPONENTS..... 13
1.1. FIGURES UNIT 13
2. DETAILS 14
3. INSTRUCTIONS FOR THE INSTALLATION OF THE SENSORS AND THE SUPPOSED SHELTER DIRECTION 15
4. DECLARATION OF CONFORMITY 17

I. TO OUR CUSTOMERS – READING THIS MANUAL

This manual is designed to provide a comprehensive guide for a proper operation and service of your EIGENBRODT instrument. It belongs to the operation- and service people as reference.



The information contained in this manual is believed to be accurate but only applies to the machine type indicated on the previous page. If in doubt, please contact Eigenbrodt with the type and serial number of the machine. Errors and omissions expected.

Do not set the device into operation, until the operation- and service people have studied the instruction manual carefully and are familiar with all details. Operation and maintenance of the device has to be done in accordance with the details of this instruction manual.

**Please read this operation manual carefully before commissioning and attend to the instructions of the chapter "Safety instructions" and chapter "Installation".
Since it is about your safety you must have read this operation manual before you start operating the unit.**

For damages arising through non-observances of this details or through improper procedure , we do not take over any Liability !

In case of dysfunctions which can not be settled by your side: Before contact company EIGENBRODT, try to detect the reason of the dysfunction with the help of this instruction manual.

Copyright 2018 by Eigenbrodt GmbH & Co. KG, D - 21255 Königsmoor
Ident-Nr. LAM630_1802e - Printed in Germany/changes reserved

Copyrights: The instruction manual is copyright protected. All rights reserved. To copy to translate or to convert in any electronic medium or in any machine readable form as whole or partial is not allowed. Contraventions obligate to compensation

Liability: Any claims against company EIGENBRODT relating to the hard- and/or software products described in this manual can only be made in accordance with the warranty term. Further claims are excluded; particularly company EIGENBRODT takes over no liability about the correctness of the instruction manual contents. Changes are reserved and can be done anytime without any further notification.

Descriptions for reading the manual: All pages of this instruction manual are serially numbered within chapters in passages.

EXAMPLE: III chapter 3
 1. paragraph 1
 1.1. point 1
 1.1.1. subitem 1

The position numbers of the illustrations are referring to the contents of the passages. If there is a position of an illustration named in the text, it is placed in () brackets.

To avoid any doubling of descriptions in this instruction all content referred connections are done with the help of cross-references.

EXAMPLE: in accordance with instruction or see point

II. INSTRUCTIONS

1. GENERAL

The instrument may only be deployed for the designated usage described in the operation manual. Any usage in a manner not specified in this manual is not according to the directions and forbidden. Eigenbrodt GmbH & Co. KG will take over no liability for resulting damages. The risk is to be carried solely by the operator.

Only qualified personnel may be entrusted with installation, start-up, maintenance and further instrument operation. The operation manual must be kept constantly available on site.



Warning!:

Before you start with maintenance and service, disconnect the device from mains supply. Otherwise there is danger of death or serious injury. Disconnect the mains plug from the power outlet (if applicable).



Note!:

If you should contact Eigenbrodt for help, please have the serial number of your unit available. The number is to be found on the top-left inside the sample room.



INFORMATION to be found

- Serial number
- Model
- Manufacturer information



Attention!:

During installation, maintenance and transport you must carry the obligatory protective clothing when applicable.

2. INTENDED USE

The technical regulations for operation and ambient conditions [see chapter 2.1] are to be regarded. Otherwise we do not guarantee for proper function and achievement of the stated performance data. Operation in explosive atmospheres is absolutely forbidden!

Intended use also refers to observance of the prescribed maintenance and service instructions.

2.1. PERMITTED AMBIENT CONDITIONS

The following ambient conditions apply to the stationary instruments of EIGENBRODT® :

- Ambient temperatures:
 - operation: -30°C up to + 70°C.
 - transport/storage: -30°C up to + 55°C
- In-/outdoor operation (Ex-free), during all weather conditions.
- External power: 12 V DC

A possible installation site must be examined for the following risks:



Caution!:

Is personal safety guaranteed?
Is the underground solid?
Can danger of explosion be excluded?

If one these conditions cannot be ensured the location is not appropriate for installation. In cases of doubt, please contact the EIGENBRODT GmbH & Co. KG.

Inexpert Use / Predictable Misapplication

- Sampling of fluids which do not comply with the above described specifications.
- Operation of the instrument in explosive atmosphere
- Operation in areas with risk of vibration

3. PRINCIPLE OF OPERATION

The radiation screen is meant as weather and also radiation protection for temperature and humidity sensors operating outside. Some weather conditions like sun shine and only some light (or no) wind could lead to a negative micro climate and higher temperature inside the screen, which would lead to wrong measurement results.

In order to avoid this heat build-up a aspiration is built in.

The commonly used Multi-Plate-shape consists of 7 plates in total, of which the 4 bottom plates function as the measurement chamber. The 5th plate with the ventilator covers the chamber is the cover of the measurement chamber. The 6th and 7th plate acts s a radiation screen, having the 7th plate approx. 50mm bigger in diameter, giving an additional protection against weather and radiation. The plates are specially made out of a 2-phase plastic material with the top layer out of reflecting, white weather-resistant material and the bottom layer out of matt black material absorbing reflected long wave ground radiation. The used material is UV-resistant for long term operation.

At the bottom of the measurement chamber there is a plastic slice and a stainless steel mounting bracket.

The screen is able to hold up to 4 Sensors at once.

As for thermal insulation to e.g. a mast there is a plastic insulating bush provided.

4. SAFETY INSTRUCTIONS



PLEASE READ THE INFORMATION OF THIS COMPLETE PARAGRAPH BEFORE PUTTING THE INSTRUMENT INTO OPERATION!

This device is manufactured in accordance with safety regulations and controlled and has left the factory in safety controlled perfect condition. The perfect function and operational Liability of the device can only be guaranteed, if during use the general local safety regulations receive attention and attention is paid to the special references to safety in this instruction manual.

The operating safety and proper function of the instrument is only ensured with observance of the generally applied safety precautions and the specific security advice of this operation manual.

The staff assigned to installing, commissioning, maintaining and operating the instrument must carefully read and understand the operation manual.

Generally the personnel must have the adequate qualification for the specific work.









The operation manual must be kept constantly available on site.

- Before connecting the device with the electricity supply system ensure that the circuit voltage which is marked on the appliance is in accordance with the supply voltage.
- The perfect function and the operational Liability of the appliance can only be ensured under the climate conditions specified in chapter II.2.1 "permitted ambient conditions " of this instruction manual.
- Alignment-, service- and repair works should only be done by an authorized expert.
- If the device is thought to be damaged or broken in such a way as to be dangerous. It should be taken out of service and prominently labelled of unserviceable.
- The safety of the user could be reduced , for example, if the device
 - o shows visible damaged parts,
 - o does not work as described,

- was stored under wrong conditions,
- was forwarded under difficult transport conditions.
- In case of doubt send the device generally to the manufacturer for service or repair, respectively it should be controlled through an authorized expert.
- In case of electrical disturbances contact exclusively an authorized expert.
- There is a **higher risk** of accident during service- and maintenance works.

4.1. SYMBOL AND HINT EXPLANATION

This instruction manual utilizes following signs to draw the attention to difficulties and dangerous situations for the appliance and the operational staff:

| | | | |
|---|--|---|---|
|  | This symbol gives important tips for the appropriate work and stands for technical peculiarities, which requires attention from the user. |  | Caution! This Symbol means a possible dangerous situation! Stands for directions which must absolutely be obeyed to exclude risk of fatal injury. |
|  | Stands for working- and operation methods which have to be followed exactly to prevent damages of persons, the device or environment. |  | This symbol means a possible imminent danger for the live and health persons Draws attention to correct procedures acting with electrical power. |
|  | Mandatory sign! Wear Safety shoes |  | Mandatory sign! Use safety glasses |
|  | Mandatory sign! Wear gloves |  | Mandatory sign! Use safety helmet |

4.2. SAFE WORKING WITH THE INSTRUMENT

Only apply the instrument under the described conditions (chapter II.2.1). Operation beyond these conditions is not intended.

- **Caution:** Before servicing/maintaining the instrument, you have to stop and unplug it.
- The operator of the instrument has to assure that the valid EEC guidelines and national laws for occupational health and safety will be observed.
- The same applies to the regulations for accident prevention.
- The operating instruction manual is meant not only for beginners. It is also intended as a reference book containing tips, hints and suggestions.



- Note: Please employ only spare parts, accessories and special equipment which have been approved by EIGENBRODT.
- When passing on the instrument to someone else, please assure to also pass on the complete technical documentation.
- If an instrument has to be returned to EIGENBRODT (e.g. for repair), it must be cleaned before and must not contain any hazardous material. If not, the instrument will be cleaned at the customer's expense.

5. TRANSPORT AND RETURN



Control and note if there is any transport damage to the device or the accessories. Damage and other defects for example incompleteness have to be notified in written form to the forwarder or to company EIGENBRODT immediately.
Inform the carrier and EIGENBRODT immediately

For transportation or possible return of the instrument to EIGENBRODT or repair please consider the following points:

- Disconnect the instrument from mains and other supply lines
- Stretch wrap the instrument and then pack it inside an appropriate cardboard box for transport.

| | | |
|----------------------------------|----|--------------|
| packing sizes | | |
| length x width x height | cm | 43 x 59 x 39 |
| weights: | | |
| total weight including box | kg | 5,5 |
| total weight excluding box | kg | 3,3 |

6. DISPOSAL

Packaging:

The packaging materials wood, cardboard box and PE can be disposed at the regular disposal points.

Device:

Please consider environmental compatibility, health risks and local disposal directions. Thus you should clean and disinfect the instrument and dispose it at one of the authorised disposal points. Detailed information should be available at the responsible authority.



Warning:
Disconnect the instrument from mains and other supply lines.

Separate the material groups in order to dispose the materials in an environmentally compatible way.

III. TECHNICAL DATA

1. ELECTRICAL DATA

1.1. CONNECTED LOADS ELECTRICAL POWER SUPPLY

| | | |
|----------------------------|-----|----|
| mains voltage | VDC | 12 |
| total connected load | mA | 90 |

2. RATINGS

2.1. AREA REQUIRED OVERALL

| | | |
|---|------------------------|---|
| Minimum. | approx. m ² | 5 |
| including: room for operation and maintenance | approx. m ² | 4 |

2.2. DIMENSIONS

| | | |
|-------|------------|--------------|
| | approx. cm | 44 x 29 x 36 |
|-------|------------|--------------|

2.3. WEIGHT OVERALL

| | | |
|---------------------------|----|-----|
| Inclusive STEG 6003 | kg | 3,3 |
| Exclusive STEG 6003 | kg | 3,0 |

2.4. WORKING TEMPERATURE

| | | |
|-------|----|-----------|
| | °C | -30...+70 |
|-------|----|-----------|

2.5. SENSORS

| | | |
|--|----|--------|
| Capacity sensors rod type | | max 4 |
| Clamping diameter for sensors rod type | mm | Ø18-25 |
| Maximum inside length for sensors | mm | 160 |

2.6. MOUNTING

| | | |
|--|----|-----------|
| Mit Isolierbuchse Dornaufnahme | mm | Ø12, l=60 |
| Ohne Isolierbuchse: vertikale Rohrklemmung | mm | Ø 30-35 |

IV. INSTALLATION AND SETTING INTO OPERATION

In order to guarantee a safe operation please make sure before installing that:



- there is no transport damage.
- the unit has not been stored in inappropriate conditions for a longer time.
- the unit does not have any visible damage.

In case of doubt please contact EIGENBRODT

1. LOCATION

Normally the location be chosen so that any surrounding obstructions such as trees, bushes and buildings subtend an angle of less than 45° from horizontal. All obstacles should be at least as for distant as their height.

2. MECHANICAL INSTALLATION

- The proposed installation height is of the temperature sensors (middle of the sensor element) is approx. 2 m above ground. When using a LTS 2000 temperature sensor, the bottom part of the insulating bush is to be approx. 1770 mm above ground.
- The mechanical connection of the LAM 630 to the structure is done by sliding the LAM 630 onto a thorn (Ø 12 mm, 60mm long) and fastening afterwards with the 2 hexagonal nut screws. This is shown in the 2 following pictures. (thermal decoupling bush is optional)
- Mounting **without** the insulating bush may be done by sliding the shelter onto a mast-end (35mm diameter) and fastening the 4 screws (holding the 2 stainless steel bows) on the front side of the shelter.
- The control unit STEG 6003 is already assembled to the LAM 630
- The lamellar shelter has to be directed according to diagram "Instructions for installation of the sensors and the supposed shelter direction".(See chapter Iv. 2)

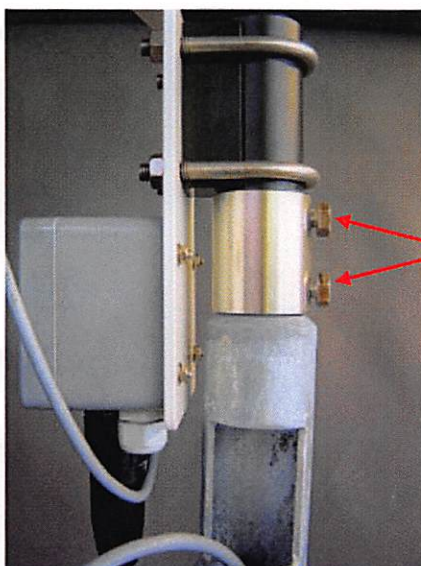

M8 x 16 mm

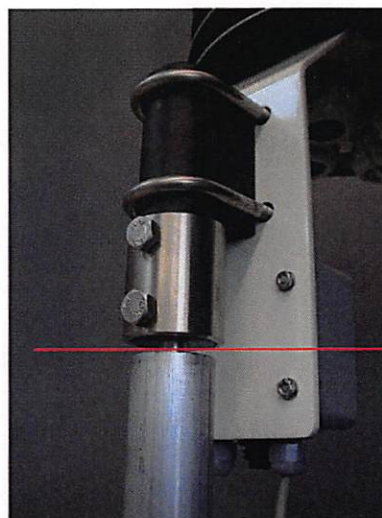

1.770mm

2.1. ELECTRICAL CONNECTIONS TO THE POWER SUPPLY



The regulations of the power supply company should to be followed



The electrical connections are to be carried out in accordance with the relevant local codes and regulations by an expert.
The protector ground has to connected very carefully.
Mistakes can cause danger to life !

- The control unit STEG 6003 is connected to the data acquisition and supply mains via an 7-pole plug. The wire descriptions are shown in the following table.
- The connection is to be proceeded according to the wiring diagram 6003.2.026 "Control unit STEG 6003, Pin assignment connection cable".

| Name | Wire-colour | Description |
|--------------------|--------------|--|
| Ground | Green/yellow | Ground |
| + 12 V DC | Brown | Power supply |
| GND | White | Ground |
| Signal ventilation | Green | Is +12 V DC when the rpm<2500 Is + 0 V DC when the rpm>2500 |
| GND | Yellow | Ground |
| Signal "darkness" | Grey | Is +12 V DC when there is darkness Is + 0 V DC when there is light |
| Signal rpm | Pink | Digital square signal with 2 pulses every round: +12 V DC Nominal round speed is: 3560 rpm ± 100 This equals to 7120 pulses per minute ± 200 |

3. MOUNTING THE SENSORS

- In case there are some spots for sensors not used, please remove the cable glands and close the openings with the according blank plugs.

It is possible to install all rod type sensors diameter 18-25 mm (smaller with adapter rings as optional items)



The humidity and temperature sensors have to be placed according to diagram "Instructions for installation of the Sensors and the supposed shelter direction".

V. OPERATION

1. ADVICE FOR OPERATION



There is a lens at front of the control unit STEG 6003. This lens is lighted red in case the unit is powered and the ventilator speed is below 2500rpm. Therefore it is a good indicator on malfunction of the ventilator as it is switched off at normal operation.

2. TAMPERING, WARRANTY LIMITATION



If the instrument is changed or remodelled in any way without the written agreement of EIGENBRODT the collector will no longer be guaranteed.

3. MAINTENANCE AND REPAIRS

3.1. CARE OF INSTRUMENT

During care, maintenance and service jobs please take care of the safety precaution instructions at the beginning of this manual.

Under normal conditions and with the correct care and maintenance, your instrument should operate for several years without problems.

3.2. MAINTENANCE WORKS



Note:

The service works has to be done at set intervals to ensure a perfect operation of the device. The care and maintenance of major components and circuits is best left to trained technicians. Maintenance on the instruments, please check the according manuals.

- The screen is mostly maintenance free. It shall be cleaned at demand with some clear water and clean and a cloth. (do not use chemicals).
- Upon longer operation check the contacts in the connector for corrosion.

VI. TECHNICAL DOCUMENTATION

1. EXPLANATION OF COMPONENTS

1.1. FIGURES UNIT

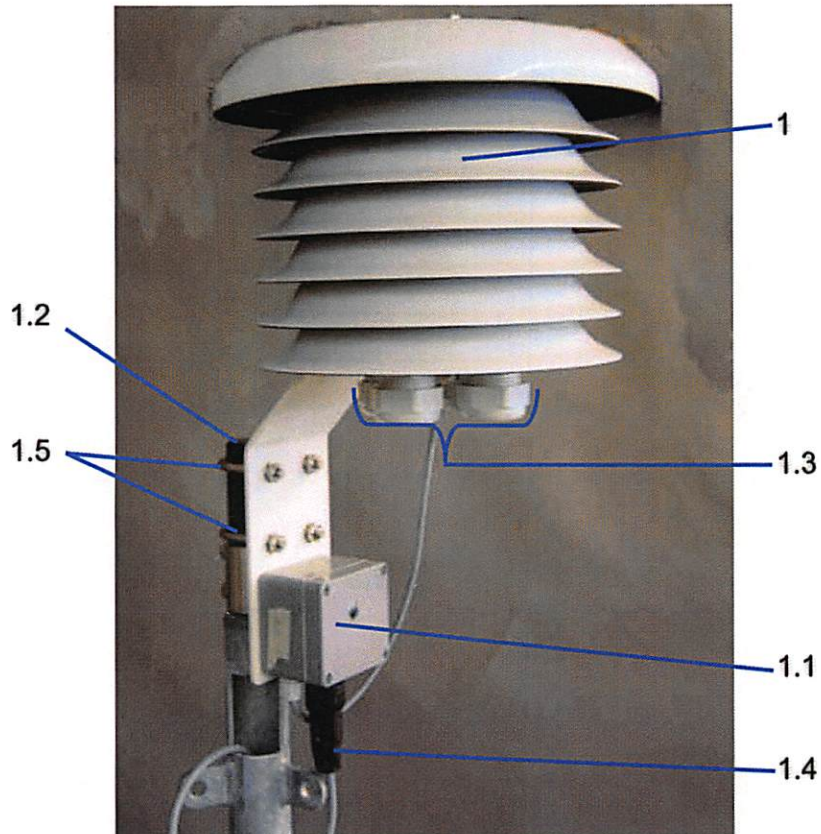

| Position | Description |
|----------|--|
| 1 | Radiation screen LAM 630 |
| 1.1 | Electronic control unit STEG 6003 |
| 1.2 | Insulating bush |
| 1.3 | PG-cable glad type 29 for sensors diameter 18-25mm |
| 1.4 | Plug and cable (2,5m) for STEG 6003 |
| 1.5 | Stainless steel bow |

2. DETAILS

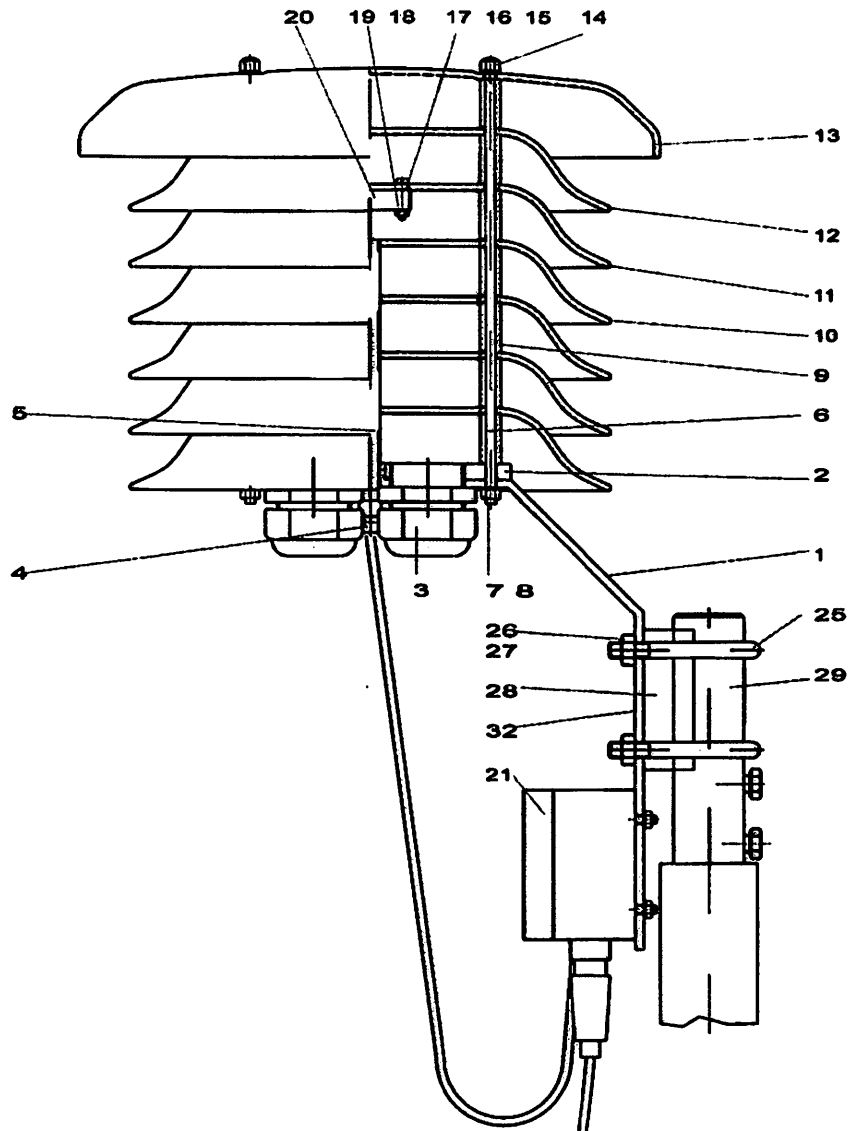

| Pos. | EA | Beschreibung | Pos. | EA | Beschreibung |
|------|----|--------------------------|------|----|-------------------------------------|
| 1 | 1 | mount | 14 | 4 | Nut DIN 917 M5 A4 |
| 2 | 1 | Disk | 15 | 4 | Cylinder head screw DIN 84 M3x22 A4 |
| 3 | 4 | Gland PG 29 HSK/K | 16 | 8 | Washer DIN 125A Ø 3,2 A4 |
| 4 | 1 | Gland PG 9 HSK/K | 17 | 4 | Nut DIN EN 24032 M3 A4 |
| 5 | 1 | Cable conduit | 18 | 1 | Strain-relief |
| 6 | 4 | Threaded bar | 19 | 1 | Cable tie |
| 7 | 8 | Washer DIN 125A Ø 5,3 A4 | 20 | 1 | Ventilator with cable , modified |
| 8 | 4 | Nut DIN EN 24032 M5 A4 | 21 | 1 | Control unit STEG 6003 |
| 9 | 28 | Hull | 25 | 2 | Rod shackle |
| 10 | 4 | Bottom plater | 26 | 4 | Nut DIN 934 M8 VA |
| 11 | 1 | Ventilator plate | 27 | 4 | Washer DIN 125 Ø 8,5 VA |
| 12 | 1 | Isolation plate | 28 | 1 | Distance block |
| 13 | 1 | Upper plate | 29 | 1 | Insulating bush (complete) |

3. INSTRUCTIONS FOR THE INSTALLATION OF THE SENSORS AND THE SUPPOSED SHELTER DIRECTION

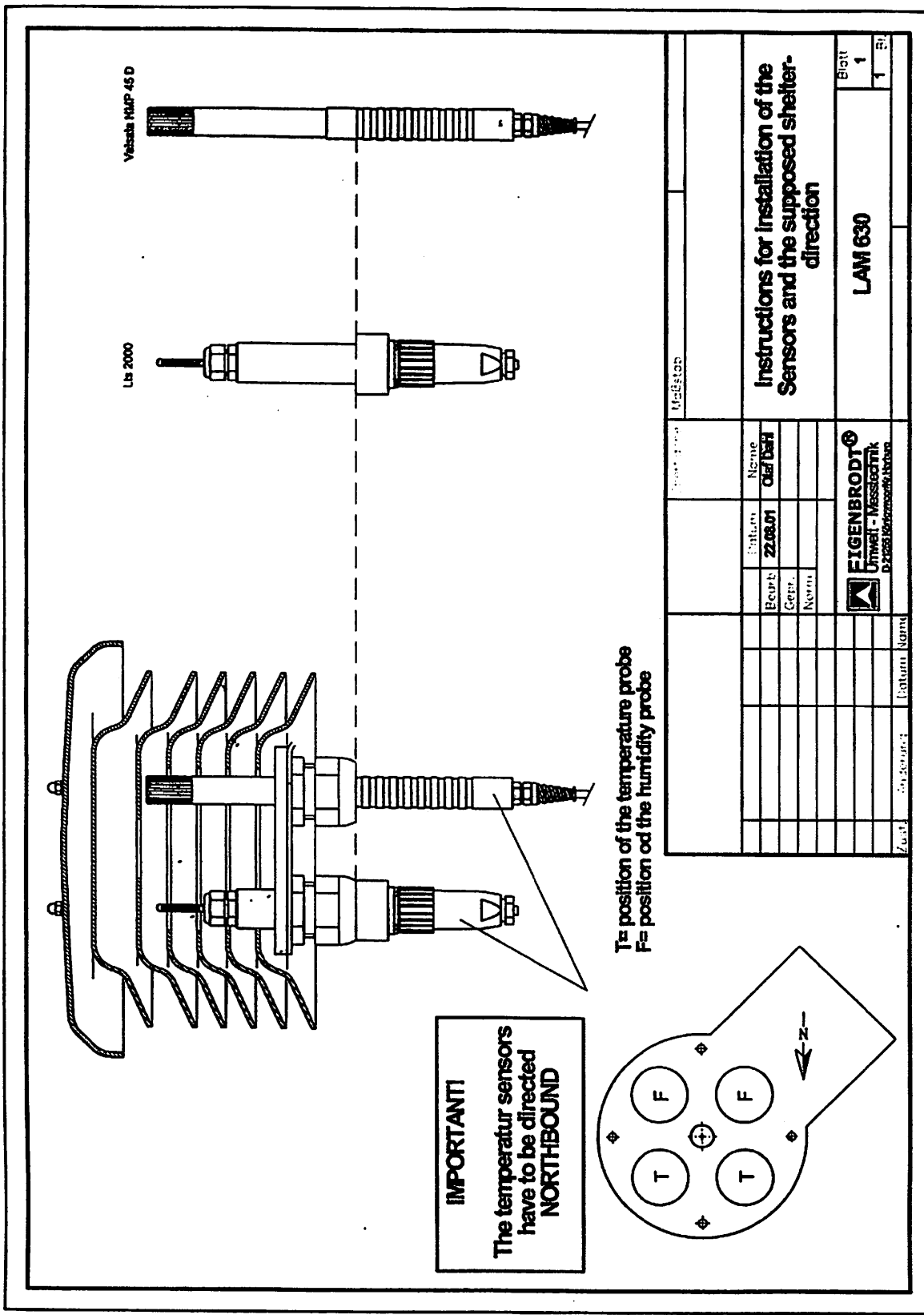

Comment: The here shown sensor models are only exemplary

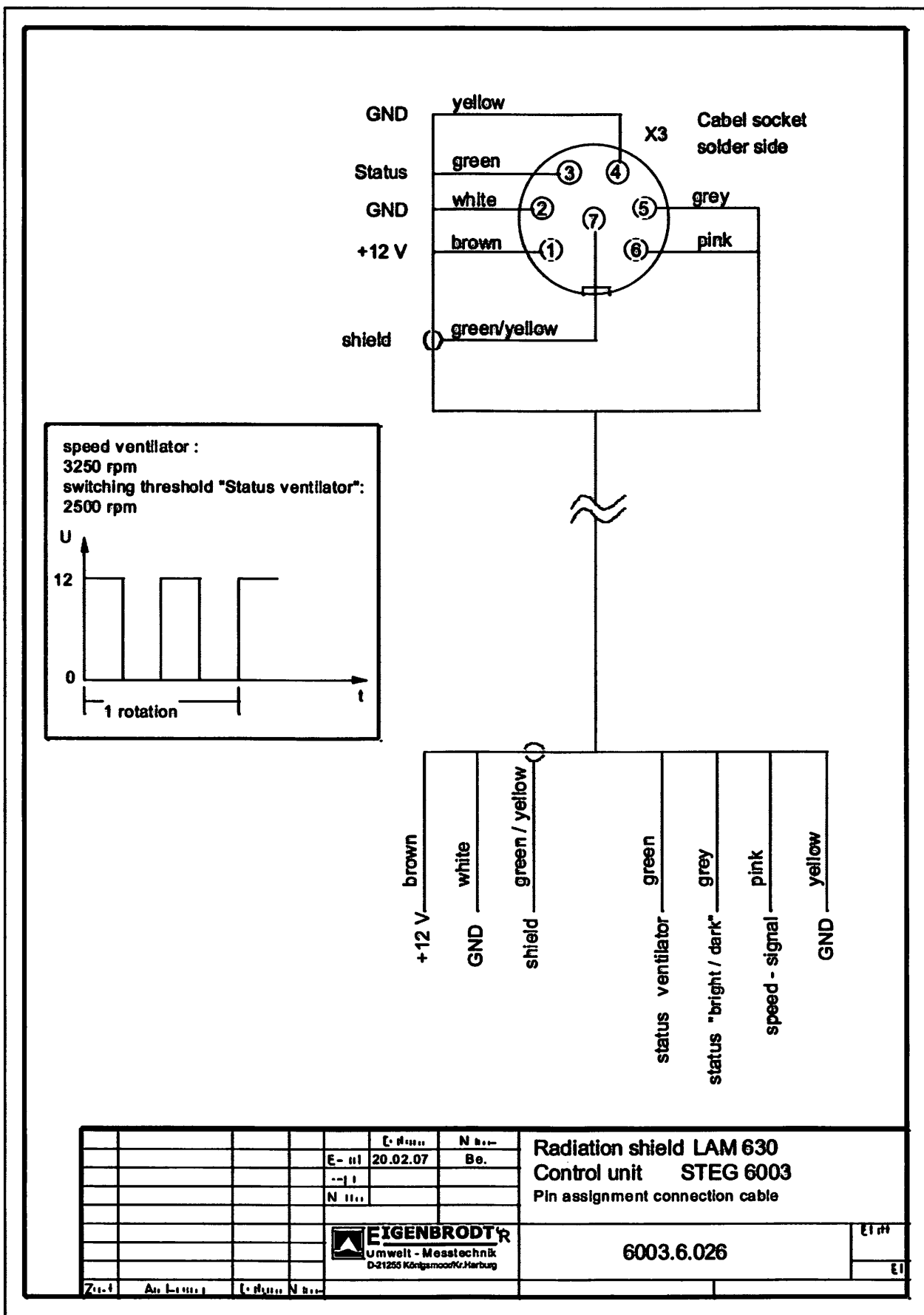

4. DECLARATION OF CONFORMITY

Der Unterzeichner, der den nachstehenden Hersteller vertritt, / *The undersigned, representing the following manufacturer:*

Eigenbrodt GmbH Co. KG
Baurat-Wiese-Straße 68
D-21255 Königsmoor

erklärt hiermit, dass das Produkt / *herewith declares that the product:*

Produkt: Niederschlagssammler / *Product: Precipitation collector*
Modell: LAM 630 und STEG 6003 / *Model: LAM 630 und STEG 6003*
Seriennummer: / *Serial number: 000001 bis n / 000001 to n*

2004/108/EG Richtlinie 2004/108/EG des Europäischen Parlaments und des Rates vom 15. Dezember 2004 zur Angleichung der
2004/108/CE Rechtsvorschriften der Mitgliedstaaten über die elektromagnetische Verträglichkeit und zur Aufhebung der Richtlinie
89/336/EWG.

*Directive 2004/108/EC of the European Parliament and of the Council of 15 December 2004 on the approximation of the laws
of the Member States relating to electromagnetic compatibility and repealing Directive 89/336/EEC.*

und, dass die folgenden Normen und/oder technischen Spezifikationen zur Anwendung gelangt sind.
and that the mentioned standards and/or technical specifications have been applied.

•EMV-Richtlinie/EMV-Guideline EN 61000-4-2, EN 61000-4-3, EN 61000-4-4, EN 61000-4-6

Der Unterzeichner, der den nachstehenden Hersteller vertritt, / *The undersigned, representing the following manufacturer*

Eigenbrodt GmbH & Co. KG
Baurat-Wiese-Straße 68
D-21255 Königsmoor

Bevollmächtigt zur Zusammenstellung der technischen Unterlagen gemäß Anhang VII A
Authorised to compile the technical documents according to appendix VII A

Königsmoor, den 01.11.2011
Königsmoor, the 01.11.2011



Olaf Dahl
Geschäftsführer / *Managing Director*